

# Minimising Release and Environmental Implications of Chlorine and its Compounds



**Central Pollution Control Board**  
(Ministry of Environment & Forests, Govt. of India)  
Parivesh Bhawan, CBD-cum-Office Complex,  
East Arjun Nagar, Delhi-110 0032

*(September, 2008)*



ज. मो. माऊसकर, भा.प्र.से.  
आ.व.सं.  
J. M. MAUSKAR, IAS  
Chairman

## केन्द्रीय प्रदूषण नियंत्रण बोर्ड

(भारत सरकार का संगठन)

पर्यावरण एवं वन मंत्रालय

Central Pollution Control Board

(A Govt. of India Organisation)

Ministry of Environment & Forests

Phone : 22304948/22307233

### FOREWORD

Chlorine and its compounds are used extensively in the manufacture of many industrial and consumer products such as PVC, pulp & paper, textiles, pesticides, pharmaceuticals, and dye & dye intermediate and are also used for disinfection of water all over the world. These applications are however associated with possible serious environmental and health risks as several chlorine compounds are toxic chemicals. In fact most of the Persistent Organic Compounds (POPs) are chlorine compounds. A study was therefore conducted on the optimization of the use of chlorine / chlorine compounds in the country for identification of areas where their use could be minimized or even substituted for eliminating the associated environmental problems. The details of the study conducted, the findings and recommendations are presented in this document.

The survey study was conducted by the National Environmental Engineering Research Institute (NEERI), Nagpur and the report submitted to CPCB in the year 2004, for which I am grateful to the Institute.

It is hoped that the document will be a useful reference for minimization of the release of chlorine or its compounds even though there may have been some technological up gradation since the submission of the Report by NEERI in 2004.

(J. M. Mauskar)

Place: Delhi.

Date: 23 October 2008

## PROJECT TEAM

- Dr. B. Sengupta, Member Secretary : Overall supervision
- Sh. P. M Ansari, Additional Director : Coordination for report finalisation
- Dr. R. S. Mahwar, Additional Director : Project initiation, monitoring, and supervision; Report finalization and editing
- Ms. Mita Sharma, Senior Environmental Engineer : Follow up for Project Completion
- Sh. Shriance Jain, Environmental Engineer : Follow up and assistance in project coordination and monitoring
- Ms. Divya Sinha, Environmental Engineer : Follow up for Project Completion
- Sh. Nazim Uddin, Environmental Engineer : Report revision
- Ms. Roopa Priya, JRF : Assistance in Report Preparation
- Ms. Rajni Arora, PS : Report Typing

## CONTENTS

| Sl. No. | Title  | Page |
|---------|--|------|
| 1.      | <b>Introduction</b>                                      | 1    |
| 1.1     | Aims and Objectives                                      | 1    |
| 1.2     | Scope of Study   | 1    |
| 1.3     | Methodology  | 3    |
| 2.      | <b>The Chlor-alkali Industry Sector</b>                  | 4    |
| 2.1     | Background   | 4    |
| 2.2     | Capacity and Production of Chlor-alkali Industry         | 5    |
| 2.3     | Chlorine Production and Utilization                      | 6    |
| 2.4     | Manufacturing Process                                    | 7    |
| 2.5     | Identified Units for field studies                       | 7    |
| 2.6     | Estimated Chlorine Losses                                | 7    |
| 2.7     | Sources of Chlorine Emissions                            | 7    |
| 3.      | <b>PVC and Related Products Sector</b>                   | 13   |
| 3.1     | The Status of PVC Industry                               | 13   |
| 3.2     | Manufacturing Process of VCM and PVC                     | 14   |
| 3.3     | Production, Consumption and Demand Growth of PVC         | 14   |
| 3.4     | Chlorine Consumption and Demand for PVC                  | 15   |
| 3.5     | Identified units for field studies                       | 15   |
| 3.6     | Emissions / Losses from VCM Plant                        | 16   |
| 3.7     | Emissions / Losses in PVC Manufacturing Plants           | 19   |
| 3.8     | Sources of Chlorine Losses in VCM & PVC Plants           | 20   |
| 3.9     | Minimisation / Emission Control Techniques in VCM Plant  | 22   |
| 3.10    | Emission Control Techniques for PVC Manufacturing Plants | 22   |
| 3.11    | Substitute to PVC & Related Products                     | 22   |
| 4.      | <b>Chlorinated Paraffin Wax (CPW) Industry Sector</b>    | 25   |
| 4.1     | General  | 25   |
| 4.2     | The Status of Chlorinated Paraffins Industry             | 25   |
| 4.3     | Manufacturing Process                                    | 25   |
| 4.4     | Production and Estimated Demand of CPW                   | 26   |
| 4.5     | Chlorine Consumption and Estimated Demand in CPW         | 26   |
| 4.6     | Identified units for field studies                       | 26   |
| 4.7     | Emission of Chlorine                                     | 29   |
| 4.8     | Emission Control Techniques                              | 30   |
| 4.9     | Areas for Minimisation of Emissions                      | 31   |
| 4.10    | Alternative to CPW                                       | 31   |
| 5.      | <b>Pulp &amp; Paper Sector</b>                           | 33   |
| 5.1     | General Standards  | 33   |
| 5.2     | Technology Status  | 33   |
| 5.3     | Production of Paper Growth and Demand                    | 34   |
| 5.4     | Pulp & Paper Manufacturing Process                       | 34   |

|            |   |           |
|------------|---|-----------|
| 5.5        | Chlorine Consumption in Pulp & Paper Industries                       | 34        |
| 5.6        | Formation of Organochlorine during Chlorine Bleaching                 | 34        |
| 5.7        | Minimisation of Organochlorine formation through process modification | 35        |
| 5.8        | Environmental problems  | 36        |
| 5.9        | Identified units for field studies                                    | 36        |
| 5.10       | Regulatory Status on Discharge of AOX                                 | 38        |
| 5.11       | Substitute Chemicals for Elemental Chlorine                           | 39        |
| <b>6.</b>  | <b>Organic Chemicals Sector</b>                                       | <b>41</b> |
| 6.1        | General Status  | 41        |
| 6.2        | Chloromethanes  | 41        |
| 6.3        | Identified units for field studies                                    | 43        |
| 6.4        | Chlorobenzenes  | 48        |
| 6.5        | Chloroethanes   | 49        |
| 6.6        | Propylene Oxides  | 49        |
| 6.7        | Epichlorohydrin   | 50        |
| 6.8        | Monochloro Acetic Acid  | 51        |
| 6.9        | Other Organic Chemicals   | 52        |
| <b>7.</b>  | <b>Pesticides Sector</b>  | <b>53</b> |
| 7.1        | General Status  | 53        |
| 7.2        | Technological Status  | 55        |
| 7.3        | Production, Consumption and Demand of Pesticides                      | 55        |
| 7.4        | Chlorine Consumption and Pesticides                                   | 56        |
| 7.5        | Export / Import   | 57        |
| 7.6        | Pesticides and Persistent Organic Pollutants (POPs)                   | 58        |
| 7.7        | Alternatives to POPs  | 59        |
| 7.8        | Alternatives to Pesticides  | 59        |
| <b>8.</b>  | <b>Inorganic Chemicals Sector</b>                                     | <b>61</b> |
| 8.1        | General Status  | 61        |
| 8.2        | Chlorine Consumption  | 61        |
| 8.3        | Stable Bleaching Powder   | 61        |
| 8.4        | Chloro Sulphonic Acid   | 62        |
| 8.5        | Calcium Hypochlorite  | 63        |
| 8.6        | Sodium Hypochlorite   | 63        |
| 8.7        | Hydrochloric Acid   | 64        |
| 8.8        | Other Inorganic Chemicals   | 64        |
| <b>9.</b>  | <b>Water and Wastewater Treatment Sector</b>                          | <b>65</b> |
| 9.1        | Water Treatment   | 65        |
| 9.2        | Wastewater Treatment  | 66        |
| <b>10.</b> | <b>Dyes and Dye Intermediates Sector</b>                              | <b>67</b> |
| 10.1       | Status of the Dyes and Dye Intermediates                              | 67        |
| 10.2       | Chlorine Consumption  | 68        |
| 10.3       | Chlorine Emissions  | 68        |
| 10.4       | Challenges and Future Trends  | 68        |

|      |   |           |
|------|---|-----------|
| 11.  | <b>Pharmaceutical Sector</b>  | <b>70</b> |
| 12.  | <b>Textile Industry Sector</b>  | <b>71</b> |
| 12.1 | Production Process  | 71        |
| 12.2 | Chlorine Use in Textile Industry  | 71        |
| 12.3 | Quantity of Chlorine Required in Bleaching                                      | 71        |
| 12.4 | Chlorine Emissions in Bleaching Process   | 73        |
| 12.5 | Alternatives for Chlorine Chemicals in Bleaching Process                        | 73        |
| 13.  | <b>Conclusion and Recommendations</b>   | <b>75</b> |
| 13.1 | Environmental significance of chlorine and its compounds                        | 75        |
| 13.2 | Strategies to minimize environmental implications of chlorine and its compounds | 76        |
| 13.3 | Activities / Areas Identified for further Study                                 | 78        |

## List of Annexures

| Annexure | Title  |
|----------|--|
| 1.1      | Properties of Chlorine   |
| 2.1      | Unit-wise Installed Capacity and Production of Caustic Soda  |
| 2.2      | Chlorine Production and Utilization in India   |
| 2.3      | Production Flow Diagrams in Caustic Soda Industry  |
| 2.4      | Chlorine Production, Utilisation and its Mass Balance  |
| 2.5      | Production and Utilisation of Chlorine   |
| 2.6      | Estimated Major Contribution of Chlorine Losses  |
| 3.1      | Production Flow Diagrams of PVC Production   |
| 3.2      | Process Description, Mass Balance of PVC Production and Chlorine Utilisation -Unit I                 |
| 3.3      | Process Description, Mass Balance of PVC Production and Chlorine Utilisation -Unit-II                |
| 3.4      | Mass balance of PVC Production and major sources of emissions Chlorine Utilisation -Unit-I           |
| 3.5      | Mass balance of PVC Production and major sources of emissions Chlorine Utilisation -Unit-II          |
| 3.6      | Production Flow Diagrams and Mass Balance in PVC production Unit-I                                   |
| 3.7      | Production Flow Diagrams and Mass Balance in PVC production Unit-II                                  |
| 4.1      | Major Applications, Grades and Properties of Chlorinated Paraffin Wax                                |
| 4.2      | Process description along with model calculation on mass balance of chlorine utilization Unit-I      |
| 4.3      | Process description along with model calculation on mass balance 90 of chlorine utilization Unit-II  |
| 4.4      | Process description along with model calculation on mass balance 90 of chlorine utilization Unit-III |
| 4.5      | Process description along with model calculation on mass balance of chlorine utilization             |
| 5.1      | Pulp and Paper Manufacturing Process   |

- 5.2 Process Modification for Minimisation of Organochlorine Production
  - 5.3 Process Description of the paper mill identified for detailed study
  - 6.1 Process Description and Mass Balance in a Chloro-organic Compound Industry
  - 7.1 The Dirty Dozen and six other POPs
  - 9.1 Plant-wise Chlorine Consumption in Water Treatment Plants
-



## 1.0 Introduction

Chlorine is used in the manufacture of many industrial and consumer products such as PVC, pulp & paper, bleaching powder, textile, inorganic and organic chemicals, chlorinated paraffin wax, pesticides, pharmaceuticals, and dyes & dye intermediates. Chlorine is also used extensively in the disinfection of drinking water and wastewater treatment. The involvement of chlorine and its compound in these applications is also associated with serious environmental and health risks as several chlorine compounds are toxic chemicals, which persist for long periods in the environment without breaking down and are recognized among the most dangerous pollutants resulting from human activities. Most of the Persistent Organic Pollutants (POPs) such as organo-chlorine pesticides, polychlorinated biphenyls (PCB) and hexachlorobenzenes (HCBs) are chlorine compounds. Some chlorine compounds also result in generation of POPs. For example, dioxins and furans are produced during incineration of the wastes containing chlorine compounds such as PCBs & PVC. It is essential to identify and minimise the environmental implications of using chlorine and its compounds. Total elimination of chlorine or its compounds is neither practicable nor desirable. However, effective monitoring and regulation of the activities involving use of chlorine or its compounds in areas where there is a scope for minimization or even elimination of emissions / discharges of chlorine or its hazardous compounds including safe handling of chlorine itself is necessary.

CPCB therefore awarded a study to NEERI on optimization of use of chlorine and its compounds in India. The study covered collection of data concerning the manufacture and use of chlorine and its compounds in the country and identification of areas where their use could be optimized or even substituted for eliminating the associated environmental implications. The details of the study conducted, the findings and recommendations are presented in this document.

### 1.1 Aims and Objectives

Identification and minimization of environmental implications of the use of chlorine and its compounds in India.

### 1.2 Scope of Study

#### 1.2.1 Status and Plans of the Chlor-alkali industries

Collection, collation and compilation of information on production and use/disposal of chlorine by the Chlor-alkali plants in India. Unit-wise as well as technology-wise (mercury cell/ membrane cell / Diaphragm cell) compilation of the data in respect of the following aspects:

- Production of chlorine;
- The projected / expected increase in the production of Chlorine by the end of 2010;
- The form (i.e. speciation) and estimated loss of chlorine in the effluents, emissions (source as well as fugitive), solid waste, hazardous waste and any other sources;
- The quantity of chlorine sold to different industries (unit wise) and their respective uses; and
- Overall mass balance with respect to the production and sale, disposal and loss of chlorine.

### 1.2.2 Status and Plan of Industries using Chlorine and / or its Compounds

Collection, collation and compilation of information on use of chlorine and its compounds in the various industrial sectors / activities -

The industrial sector/activities covered are as follows:

- i. Pulp and Paper
- ii. PVC and related products
- iii. Chlorinated Paraffin Wax (CPW)
- iv. Inorganic Chemicals
- v. Organic Chemicals
- vi. Pesticides
- vii. Water and Wastewater Treatment
- viii. Pharmaceuticals
- ix. Textile
- x. Dyes and Dye Intermediates

The details compiled for each of the above sectors / activities unit-wise (i.e. each plants) as well as technology-wise and will cover the following aspects:

- Source of supply and consumption of chlorine and its compounds;
- Projected / expected increase in the consumption of chlorine and its compounds in this sector by the end of year 2010;
- The form (i.e. speciation) and estimated loss of chlorine and its compounds in the effluents, emissions (source as well as fugitive), solid waste, hazardous waste and any other sources; and
- Overall mass balance in respect of the supply and consumption, disposal / loss of chlorine and its compounds.

### 1.2.3 Sources of the Emission of Chlorine and its Compounds

- Identification of activities / areas concerning the chlorine (or its compounds) involving activities which require priority attention for minimisation of the emissions of chlorine and its toxic compounds specially the Persistent Organic Pollutants (POPs)

### 1.2.4 Minimisation of the use of Chlorine and its Compounds

- Identification of activities of areas having possibilities of substituting chlorine use with other alternate chemical involving less environmental health hazards

### 1.2.5 Studies of the Activities involving Chlorine and its Compounds

- Identification of the activities / areas where indepth studies are required for identification and minimisation of the implications of chlorine and its compounds

### 1.3 Methodology

#### 1.3.1 Questionnaire Survey and their Responses

A questionnaire for data collection on Chlor-alkali manufacturing industries on technology-wise, viz. membrane cell, mercury cell and diaphragm cell production, sale, use, losses, emissions and disposal of chlorine and its compounds was sent through a letter of request to all the Chlor-alkali producing industries for furnishing the information. Similar questionnaire for chlorine consuming sectors was sent to consuming sector industries for collection, quantification of chlorine consumption including sources of emissions. Information was obtained from secondary sources including industries associations. Reconnaissance visits were also undertaken to understand the chlorine manufacturing technologies as well as the chlorine consuming processes like PVC, CPW and pesticides. Further, a team of scientists interacted with various industries associations for collection of information on chlorine production and consuming sectors. The information provided by the various industries was not adequate for arriving at any meaningful conclusion. Hence the survey methodology was modified as discussed in the subsequent paragraphs.

#### 1.3.2 Modified Methodology

The methodology was modified as under:

- i. The information collection focused on, (a) amount of chlorine produced / used as raw material per tonne of product (b) amount of chlorine actually consumed in the production process per tonne of the product and amount of chlorine lost per tonne of product, and (c) the sources / points of chlorine emission / losses.
- ii. Mass balance of the use of chlorine studied through site visits in few industries of the various sectors as well as through discussions with industrial associations/research institutes. Projections in respect of the different sectors made on the basis of the findings of these visits and the responses of the survey from other industries of the sectors.

#### 1.3.3 Industrial units identified for detailed studies in various sectors

|                                |   |   |
|--------------------------------|---|---|
| Chlor-alkali                   | : | 4 |
| Poly Vinyl Chloride (PVC)      | : | 2 |
| Chlorinated Paraffin Wax (CPW) | : | 3 |
| Pulp & Paper                   | : | 1 |
| Organic / Inorganic Chemicals  | : | 1 |

#### 1.3.4 Industry Associations / Research Institute identified for discussions

- Nandesari Industrial Association, Nandesari (NIA), Vadodara for CPW sector
- Indian Chemical Manufacturers Association (ICMA), Mumbai
- Alkali Manufacturers Association of India (AMAI), New Delhi
- Central Pulp & Paper Research Institute (CPPRI), Saharanpur, UP
- Gujarat Dyes Manufacturers Association (GDMA), Ahmedabad
- Bulk Drugs Manufacturers Association (BDMA), Ahmedabad

## 2.0 The Chlor-alkali Industry Sector

### 2.1 Background

Caustic Soda and Chlorine, the two basic products of Chlor-alkali industry are widely used in diverse industrial sectors, either as raw materials or as auxiliary chemicals to produce a variety of products ranging from domestic commodities to space appliances. Another co-product generated in Chlor-alkali industry is hydrogen which is mostly used for the manufacture of hydrochloric acid and as a fuel. It is also used in the hydrogenation of oils and manufacture of hydrogen peroxide.

Chlorine was in the past considered as an undesirable by-product of Caustic Soda production. It however became important as industrial raw material for thousands of commercial applications. Major consumption of chlorine in the country is in PVC manufacture, Pulp and Paper industry, chlorinated paraffin wax, pesticides, pharmaceuticals and water treatment sectors.

The industry in India primarily differs from the global market in the context that Caustic Soda is the main driver here. Caustic Soda is an internationally traded/tradable commodity while chlorine is not. Global Chlorine production is approximately 45 million tonnes per annum as against a capacity of the order of 50 million tonnes and a capacity utilisation of 90%. India's share in this is a meager 3 per cent. The per capita chlorine consumption in India is 1.1 kg as compared to 47.1 kg of Germany, 42.3 kg of USA, 42 kg of Canada and 29 kg that of Japan.

The involvement of toxic mercury and related pollution problem also resulted into a policy decision taken by the Government to stop granting permission for commissioning of the mercury cell based chlor-alkali plants.

#### Global Scenario

Three technologies are used for the commercial production of chlorine. These are mercury cell, diaphragm cell and ion-exchange membrane cell process. Majority of plants (75%) in the world manufacturing chlorine use membrane cell processes, some (11%) still use mercury cells technology and the balance are based on diaphragm technology. While in India, around 70 per cent of the chlorine production is based on membrane cell capacity, 30 per cent on mercury cell capacity (status as on march 2001).

Chlorine gas is an important industrial chemical made with a world production of about 40-43 million tonnes. It is primarily used for the manufacture of organochlorine compounds (72%) - for instance, solvents and PVC; and inorganic salts (13%) - for example titanium dioxide; bleaching pulp, paper, and textile (11%); and for disinfecting water (4%). More than half of all the chlorine is used in the production of plastics, particularly PVC, by reacting ethylene to give ethylene dichloride that in turn is converted into vinyl chloride monomer (VCM).

## Raw Material

The stoichiometric relationship between sodium hydroxide (NaOH), Chlorine (Cl<sub>2</sub>), and hydrogen (H<sub>2</sub>) is as under.

| NaCl   | NaOH   | Cl <sub>2</sub> | H <sub>2</sub> |
|--------|--------|-----------------|----------------|
| 100    | 68.43  | 60.66           | 1.73           |
| 146.14 | 100    | 88.77           | 2.52           |
| 167.85 | 112.81 | 100             | 2.84           |

The above table shows that 100 tonne NaCl on electrolysis produces 68.43 tonnes NaOH, and as co-products, 60.66 tonnes chlorine and 1.73 tonnes hydrogen. Conversely, to get 100 tonnes NaOH, 146.14 tonnes NaCl needs to be electrolysed and 88.77 tonnes chlorine and 2.52 tonnes hydrogen will be simultaneously produced. However, the salt consumption for the Chlor-alkali varies from 1.55-1.70/ECU depending on its purity.

With Indian salt production of 156 lakh MT per annum, India is self-sufficient as far as self-requirement is concerned. The price of delivered salt varies from Rs. 600/- to Rs. 1039/- per MT during 1999-2000 depending on the location of Chlor-alkali plant. The Indian chlorine plants located away from sea-shore get salt at a higher price to that extent the threat of receiving imported caustic soda is equally less due to high inland freight.

The industry continuously felt the shortage of good quality salt, especially for membrane cell plants. The salt manufacturers installed salt washeries so that good quality salt could be produced. There has been a progressive rise in the cost of salt during the last six years. The level of salt production in the country and its consumption by Chlor-alkali industry along with demand of salt for various sectors during the study period 1994-2001 is presented in Table A of Annexure 2.1.

## 2.2 Capacity and Production of Chlor-alkali Industry

Chlorine production has been growing in line with the growth of caustic soda manufacturing and has not been determined by the growth of the chlorine-based downstream industries. However, with the increasing growth of downstream sectors like PVC and CPW, chlorine is expected to attain the status of driving product in India and also in captive plants.

The caustic soda installed capacity in India, as on March 2006 was 29.11 lakh MT. The production of caustic soda during 2005-06 was 18.27 lakh MT as against 15.62 lakh MT during the year 2000-01. The industrial unit wise details of installed capacity and actual production of are presented in Table B of Annexure 2.1. Total installed capacity and actual production of caustic soda during the study period 1994-95 to 2000-01 are given in Table C of Annexure 2.1. Total combined installed capacity in terms of caustic soda and chlorine during the period 1999-00 to 2002-03 along with actual production of caustic soda during the period 1994-95 to 2000-01 are given in Table 2.1. The installed capacity of caustic soda and production of caustic soda and chlorine for the period 1994-1995 to 2000-01 is also depicted in Fig. 2.1.

**Table 2.1: Installed Capacity and Capacity Utilisation of Chlor-Alkali Industry**

| Year    | Installed Capacity (MT)<br>(NaOH + Chlorine)           | Production (MT)<br>(NaOH + Chlorine)                      | Capacity<br>Utilisation (%) |
|---------|--|---|-----------------------------|
| 1999-00 | 32,74,000  | 21,94,000   | 67                          |
| 2000-01 | 34,30,000  | 24,05,000   | 70                          |
| 2001-02 | 34,70,000  | 25,12,000   | 72                          |
| 2002-03 | 34,39,000  | 27,39,000   | 80                          |
| 2003-04 | 37,67,000<br>(NaOH: 22,17,000,<br>Chlorine: 15,50,000) | 29,03,000<br>(NaOH: 17,49,000,<br>Chlorine:<br>11,54,000) | 77                          |

Source: Basic chemicals statistics at a glance (2003-04), Ministry of Chemicals & Fertilizers, Govt. of India

**—●— Installed Caustic Soda Capacity    —■— Caustic Soda Production    —▲— Chlorine Production**

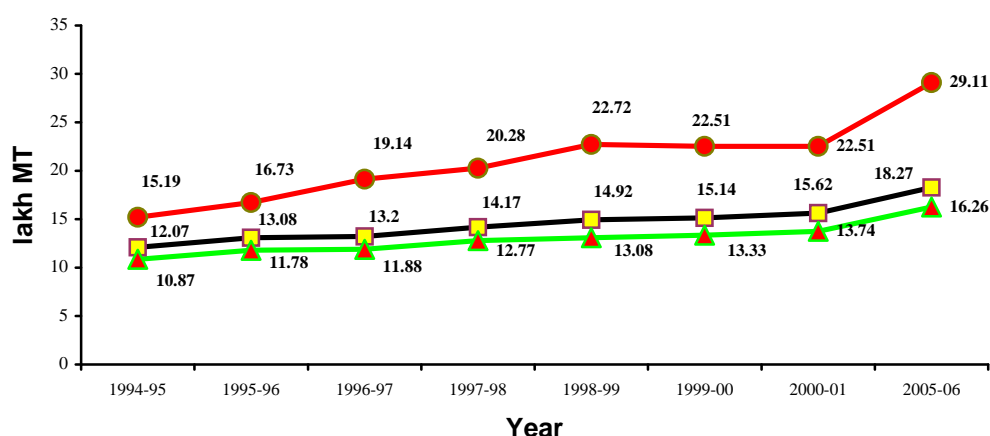

**Fig. 2.1: The Installed Capacity and Capacity Utilisation of Chlor-Alkali Industry**

Present Chlorine production is of the order of 16.26 lakh MT (2005-06) against a backdrop of Caustic Soda production of 18.27 lakh MT that corresponds to a capacity utilisation of 63% of the total caustic soda installed capacity of 29.11 lakh MT in the country. At present, there are 44 units contributing to this Chlorine production. Operating capacity utilisation of the industry was between 63 and 69 per cent over the last five years.

### 2.3 Chlorine Production and Utilisation

Chlorine production during 2005-06 is estimated to be 16.26 lakh MT. The industry-wise chlorine production, process adopted and utilisation for the year 1998-1999 and 2000-01 is presented in Annexure 2.2.

The demand for chlorine is estimated to grow from 16.26 lakh MT (corresponding to 18.27 lakh MT caustic soda) in 2005-06 to 21.47 lakh MT (corresponding to 24.13 lakh MT caustic soda) by 2009-10 assuming a Compound Average Growth Rate of 7.2% over the present production.

Chlorine in India is chiefly used in the manufacture of PVC, chlorinated paraffin wax, organics, pulp and paper, inorganic chemicals and other sectors.

## 2.4 Manufacturing Processes

Caustic soda and chlorine manufactured by 44 units using three technologies, viz. Ion-Exchange Membrane Cell Process, Mercury Cell Process and Diaphragm Cell Process. Six units are having both Mercury and Membrane Cell Processes, 26 units are having Membrane Cell Process alone, 11 units are having Mercury Process alone and there is only one unit having negligible production which uses Diaphragm Process.

| Process                   | Membrane  | Mercury  | Diaphragm | Total     |
|---------------------------|-----------|----------|-----------|-----------|
| Capacity as on 31-03-2006 | 23,03,705 | 6,00,172 | 7,250     | 29,11,127 |

In India, around 79 per cent of the chlorine production is based on membrane cell capacity, 21 per cent on mercury cell capacity.

## 2.5 Identified units for field studies

The four industries were identified for detailed in-depth studies of the activities, visits / discussion involving chlorine and its compounds. The industry wise brief process description, schematic flow sheet, chlorine emissions and their control measures are detailed in **Annexure 2.3**.

### 2.5.1 Mass Balance of Chlorine Production and Utilisation

Based on the questionnaire survey, site visits to industries and discussions held with industry people, the mass balance of chlorine production and utilisation has been studied. The information provided through questionnaire on mass balance and production & utilisation of chlorine for the four units are presented in **Annexure 2.4** and **Annexure 2.5**, respectively.

## 2.6 Estimated Chlorine Losses

Based on the information on estimated major contributions of chlorine losses for the four units are presented in **Annexure 2.6**, the major emission sources and estimated chlorine losses range from Chlor-alkali industry are presented in **Table 2.2**.

## 2.7 Sources of Chlorine Emission

The possible emission sources from chlor-alkali industry are as under:

- Brine section
- Cell house
- Chlorine drying section
- Chlorine liquefaction section (sniff)
- Liquid chlorine pump
- Chlorine evaporator
- Chlorine storage tanks (sniff)
- Leakage of sniff (unliquifiable) gas line
- Chlorine cylinder filling

- Excess chlorine treatment section (DC tower)
- Chlorine absorption in bleach liquor plant
- Hydrochloric acid plant
  - 5 kg per tonne of HCl product is lost during start-up period
  - HCl loss through air if acid could not be sold or there is a dearth of storage
  - Tail gas scrubber
- Hypo vent stack
- Power failures
  - Failure of chlorine compressor and/or suction device
  - Voltage fluctuation and consequent load fluctuation or tripping of pumps
- Miscellaneous
  - Leakage of chlorine from pump glands, flange joints, corroded pipes and valves.
  - Handling and transfer of chlorine from one vessel to another
  - Cleaning of chlorine tankers, cylinders, drums etc.
  - Improper or insufficient treatment of spent brine or its leakage



**Table 2.2 Major emission sources and estimated chlorine losses from Chlor-alkali industry**

| Sl. No. | Sources                                  | Estimated Losses                           |
|---------|--|--|
| 1       | Cell Room*                               | 0.5 - 3 ppm                                |
| 2       | Depleted brine**                         | 9 - 20 kg/MT of Cl <sub>2</sub>            |
| 3       | Chlorine liquefaction section (Sniff)*** | 71 - 85 kg/MT of Cl <sub>2</sub>           |
| 4       | Chlorine storage tanks (Sniff)***        | 6 - 8 kg/MT of Cl <sub>2</sub>             |
| 5       | Chlorine cylinder filling+               | 4 - 10 kg/MT of Cl <sub>2</sub>            |
| 6       | DC tower+                                | 4 - 10 kg/MT of Cl <sub>2</sub>            |
| 7       | Power failures+                          | -  |
| 8       | Cell cut off / cut in+                   | -  |
| 9       | Chlorine from Drying Section++           | 5 - 10 g/MT of Cl <sub>2</sub>             |
| 10      | HCl synthesis unit - Tail gas scrubber++ | 3.5 - 6 kg/MT of HCl (Chlorine equivalent) |
| 11      | Sodium hypo vent++                       | 3 - 4 kg/MT of hypo                        |
| 12      | Chimney Vent++                           | 1 - 2 kg/MT of Cl <sub>2</sub>             |

- \* Negligible quantity
- \*\* The chlorine discharge from depleted brine is recovered by HCl treatment during recycling
- \*\*\* Sniff chlorine utilised in HCl production
- +
- ++ Waste chlorine absorbed in lime solution (absorption system) Vent out to atmosphere

## 2.7.1 Emissions and their Control Measures

### i) Chlorine Emission through Chlorine Stack

Chlorine bearing waste gases from various sections of the plant are treated in the waste air dechlorination unit. The gases are scrubbed with NaOH (18%) and the unabsorbed gases are vent into atmosphere. The scrubbing is carried out in packed columns connected in series. NaOH (18%) is fed to the last column and travels counter current to the gas stream. Chlorine reacts with caustic soda to form sodium hypochlorite, which is sold as bleach lye. The heat of absorption of chlorine is removed by circulating the scrubbing liquid through coolers. The residual gases from soda hypo section are diverted to calcium hypo section for further absorption of chlorine before being vented to atmosphere.

In the calcium hypo section, slaked lime is prepared in batch mode and is used to absorb the waste chlorine gas. The lime slurry is kept in continuous circulation through the absorption towers where the waste chlorine gas is made to come in contact with lime slurry in counter-current manner. The circulation pumps and waste chlorine blowers are connected to the emergency power supply to ensure its uninterrupted operation. Thus, the waste chlorine gas from the caustic soda and chlorine plants is treated with dilute caustic soda or lime slurry in the chlorine absorption plant.

The following control measures are adopted for absorption of waste chlorine in the system.

- Two staged packed columns are provided in series at sodium hypochlorite plant. Bulk of the chlorine absorption takes place in the first column itself and the balance in the second tower. The third column acts as a polishing tower
- The system is designed to handle an emergency chlorine releases equivalent to full production of the plant for 10 minutes
- Adequate system hold up is provided to prevent the temperature from rising above 38°C in the event of a cooling water system failure.
- The composition of the scrubbing liquid is continuously monitored and controlled by an on-line redox analyser with an alarm in the control room
- An adequate buffer stock of NaOH (18%) is maintained in a head tank and in the event of an emergency the system is flooded with NaOH (18%) by the opening of an automatic on-off valve. A facility to manually open this valve is also provided
- Adequate temperature monitors and alarms are provided in the system
- All drives on this limit, viz. the blowers and circulating pumps are connected to emergency power and are on auto-start ensuring that this unit is in operation all the time
- A chlorine detector is located at the exit point of the scrubbed gas to the atmosphere.

#### ii) HCl Emissions from HCl Synthesis Unit

HCl is synthesised by burning hydrogen and chlorine. An excess of hydrogen over the stoichiometric requirement is used to ensure that there is no unreacted chlorine. The HCl gas produced in the furnace is absorbed in water. The unabsorbed HCl gas is scrubbed with water in a packed column. The dilute acid from the scrubber is monitored and in the event of a low flow, the unit is shut down safely. The HCl content in the gas leaving the scrubber is maximum 10 mg/Nm<sup>3</sup>.

The residual gases after absorption in absorber and tail gas tower is diverted to waste HCl absorber and again scrubbed with demineralised water. The resultant dilute hydrochloric acid is utilised in hydrochloric acid production by mixing with feed water.

#### iii) Handling of Emergency Chlorine Gas Leakages

The Central Control Room is equipped with 'Distributed Control Systems' (DCS) providing good number of process interlocks for plant, personnel and environmental safety. In case of power interruptions, emergency power generators starts the supply of emergency power within few seconds for important plant operations, controls and utilities.

In case of emergency, if chlorine gas pressure is reaches to very high, the rectifier trips and chlorine gas pressure released to the waste air dechlorination unit automatically. In the event of plant stoppage / start up or during operation chlorine is sucked through waste air blower and diverted to waste chlorine absorption system. The unabsorbed gases are vented to atmosphere. Caustic circulation pump and waste chlorine blowers are connected to automatic emergency back up power system. In the event of

power failure and cell cut-in and cut-outs, chlorine is diverted to waste chlorine absorption system.

In case of any emergency tripping in any plant section, to avoid consequential damage in other sections and to stop accidental releases, the emergency trip system is utilised. Sudden tripping of rectifier diverts all the plant sections handling chlorine to hypo section for neutralisation with caustic / milk of lime. This avoids accidental releases of gas in plant section and to the atmosphere. Sudden tripping of rectifier trips hydrogen blower in hydrogen handling section to avoid sucking of air into hydrogen, which leads to explosion. The interlocks are installed at chlorine, HCl plants and are described as under:

- Sudden tripping of chlorine compressor reduces rectifier load by 25% to avoid release of chlorine gas at Cell House and chlorine drying system
- Sudden tripping of Freon compressors also trips the chlorine compressor to avoid release of excess chlorine gas at hypo section
- High pressure at liquefier automatically releases chlorine to hypo section for safety reasons
- At hydrochloric acid plant, flame detection by photocell arrangements is provided to avoid explosion. Flame failure is detected and the photocell activates the shut off valves of chlorine and hydrogen. The purge nitrogen opens into the hydrogen system automatically.

During emergency, all the chlorine lines i.e. suction hood arrangement at the storage vessels, filling section, loading areas etc. are connected to the hypo tower. Industry is also required to take necessary measure to avoid pressure build-up in storage vessels to prevent any accident / release of chlorine.

The chlorine monitors are installed in and around cell house, liquid chlorine storage, cylinder filling and hypo plant. Some of the monitors are connected to the DCS room for continuous monitoring of chlorine leakages.

### Summary

The market conditions are such that caustic soda is in demand in India, while chlorine is not. Globally the industry requires more chlorine than caustic soda. Though Indian companies have excess chlorine, they can not export it simply because of the major hazards associated with the transportation of chlorine.

The ultimate use of chlorine is not within the control of the chlor-alkali industry, rather it depends on the downstream industry that makes products like plastics, pesticides, chlorinated paraffin wax and organo chemicals.

This sector is slowly moving towards cleaner technology - all new capacity addition has been in the form of membrane cells.

Environmental problems are posed by the emission of organic materials direct from the manufacturing process while the production, liquefaction, transport and storage of chlorine have considerable potential health and safety implications.

Chlorine emissions from Chlor-Alkali industry can be prevented by taking the following measures are taken.

- Adopting better manufacturing practices, chlorine emissions can be reduced
- Adopting preventive maintenance programme
- Installation of continuous monitoring system and alarm near the scrubber to monitor the level of chlorine below 1 ppm
- Treatment of bleach liquor with lime to prevent wastage of chlorine in bleach liquor

### 3.0 PVC and Related Products Sector

#### 3.1 The Status of PVC Industry

Acetylene produced from calcium carbide and HCl produced through chlorine were the chemicals initially used to produce vinyl chloride, which is further polymerized to get PVC. However, large-scale manufacture of vinyl chloride is based on ethylene feedstock. Over 90% of Vinyl Chloride Monomer (VCM) manufacturing capacity is based on the ethylene feedstock process, which combine oxy-chlorination and pyrolysis. In 1991. At present there are seven manufacturers with eight plant locations with a total capacity of 8,21,000 TPA in India. The existing production capacity (year 2001) as technologies adopted, and proposed capacities are presented in Table 3.1 and Table 3.2, respectively.

Table 3.1 PVC Technology and Capacities in India (2000-01)

| Company* | Technology  | Capacity (MTA) |
|----------|---|----------------|
| PVC-1    | CaC <sub>2</sub> →Acetylene→VCM→PVC   | 36,000         |
| PVC-2    | Imported VCM→PVC  | 60,000         |
| PVC-3    | Molasses→Alcohol→C <sub>2</sub> H <sub>4</sub> →EDC→VCM→PVC<br>Imported EDC→VCM→PVC | 40,000         |
| PVC-4    | Naphtha→C <sub>2</sub> H <sub>4</sub> →EDC→VCM→PVC                                  | 30,000         |
| PVC-5-I  | Cl <sub>2</sub><br>Naphtha→C <sub>2</sub> H <sub>4</sub> →EDC<br>HCl→VCM→PVC        | 55,000         |
| PVC-5-II | Imported C <sub>2</sub> H <sub>4</sub> →EDC→VCM→PVC<br>Captive Chlorine             | 150,000        |
| PVC-6    | Imported C <sub>2</sub> H <sub>4</sub> →EDC→VCM→PVC<br>Imported EDC                 | 300,000        |
| PVC-7    | Imported C <sub>2</sub> H <sub>4</sub> →EDC→VCM→PVC<br>Imported EDC                 | 150,000        |
|          | Total   | 8,21,000       |

\*PVC-1, PVC-2, PVC-3----- are the code names of the PVC industrial plants

Table 3.2: PVC New Units / Expansion Plans in India

| Company           | Technology           | Capacity (MTA) |
|-------------------|----------------------|----------------|
| PVC-3 (expansion) | Imported EDC→VCM→PVC | 150,000        |
| PVC-5 (expansion) |                      | 150,000        |
| PVC-6 (expansion) | Imported EDC→VCM→PVC | 300,000        |
| PVC-7 (expansion) | Imported EDC→VCM→PVC | 120,000        |
| PVC-8             |                      | 150,000        |
| PVC-9             |                      | 80,000         |
| PVC-10            |                      | 150,000        |
| PVC-11            |                      | 150,000        |

The PVC consumption in India is expected to grow to more than one million tonne per annum in the next few years, whereas the locally produced Chlorine which is expected to go into the same will be less than 2 lakh MT. A lot of Ethylene capacity is coming up in India. It would have been most logical for the Indian PVC manufacturers to source their Ethylene and Chlorine within the country instead of

importing EDC. The only reason for the contrary happening is the high cost of producing chlorine in India.

### 3.2 Manufacturing Process of VCM and PVC

The VCM molecule is made-up of 43% ethylene and 57% chlorine by weight. These are primary feedstocks. Intermediate feedstock is EDC. The VCM requirement for PVC production is 1.014 MT/MT of PVC. Suspension polymerisation of Vinyl Chloride is by far the most important technique constituting about 80% of total PVC produced in the world. This is followed by emulsion process with a production capacity of about 10% and bulk process around 8-10%. A small quantity of PVC is also produced by solution polymerisation technique. In India, most of the PVC is produced by suspension polymerisation technique and remaining is based on emulsion polymerisation technique.

### 3.3 Production, Consumption and Demand Growth of PVC

The PVC production in 1996-97 was 5.6 lakh MT and 6.68 lakh MT in 1999-2000. The production of PVC in 2009-10 would be around 20,71,000 MT by considering all incoming expansion capacities.

In India, PVC demand had grown at a rate of 13% during 1987-1997 and the demand is expected to grow at 14% till 2010. The annual per capita consumption of PVC in India is about 0.5 kg compared to a world average of 4 kg. Even with the expected annual growth rate of 14% the per capita consumption is estimated to grow only about 1.0 kg by 2003 and about 1.5 kg by 2010. Over 60% of PVC produced finds applications in the building & construction industry & in agriculture. With prospects of strong investments in the infrastructural and agricultural sectors, the PVC consumption in India is expected to maintain a healthy growth. The estimated PVC consumption for the year 2009-10 is presented in Table 3.3.

Table 3.3: Sectoral Consumption Growth of PVC in India, (1000 TPA)

| Sl. No.      | Sector           | Actual Consumption 1996-97 | Growth Rate (%) | Projected Consumption 2009 - 10 |
|--------------|------------------|----------------------------|-----------------|---------------------------------|
| 1.           | Pipes & Fittings | 247.52                     | 15              | 1429                            |
| 2.           | Rigid Films      | 19.04                      | 20              | 366                             |
| 3.           | Flexible         | 72.24                      | 10              | 220                             |
| 4.           | Wire & Cable     | 73.92                      | 10              | 273                             |
| 5.           | Hoses & Tubes    | 38.08                      | 10              | 38                              |
| 6.           | Footwear         | 59.36                      | 10              | 182                             |
| 7.           | Profiles         | 12.32                      | 20              | 205                             |
| 8.           | Bottles          | 17.92                      | 0               | 6                               |
| 9.           | Medical & Others | 19.6                       | 25              | 247                             |
| <b>Total</b> |                  | <b>560</b>                 | <b>14*</b>      | <b>2965</b>                     |

\* Average

The demand of PVC was 4,70,000 MT in 1995. By 2010 the demand of PVC for various sectors would be 29.65 lakh MT with an annual growth rate of 14%.

### 3.4 Chlorine Consumption and Demand for PVC

The chlorine consumption in PVC is dependent on following factors:

- Demand of PVC
- Quantity and nature of EDC supply; whether based on domestic or Imported EDC
- Manufacturing route adopted and availability of facilities for oxy-chlorination of EDC.

The chlorine consumption patterns based on quantity and nature of EDC and on manufacturing route of PVC are presented in **Annexure 3.1**. The consumption norms of chlorine for PVC production are as under:

- 630 kg chlorine is required for one tonne of EDC
- 593 kg chlorine is required for one tonne of VCM
- 1.014 MT of VCM is required for one tonne of PVC

Unit PVC-4 and PVC-5 utilised 0.63 T/T chlorine by Oxy-chlorination process and Unit PVC-3 utilised 1.21 T/T chlorine by without oxy-chlorination process. PVC-1 and PVC-2 is based on HCl and imported VCM route, respectively. Whereas, PVC-6 and PVC-7 are based on imported EDC. The total chlorine consumption for PVC production was 83,775 T in 1996-97; 1,46,800 T in 1997-98; 1,78,300 T in 1998-2001 and 1,78,300 T in 2001-02.

#### The Future chlorine Demand

As new units / plant expansion is expected to be based on imported EDC, the consumption of chlorine by PVC sector in the coming years will be 1,78,300 T. The future chlorine consumption by PVC will continue to depend on EDC. If Unit PVC-5 increases its capacity by 150 MT by 2010, the chlorine consumption will increase from 1,78,300 to 2,72,800 T registering a growth of 15.7% CARG. The determinants of chlorine demand in future are as follows:

- Future demand for PVC and extent and nature of PVC capacity being created
- Quantity and nature of EDC supply, whether based on domestic or imported EDC
- Production of EDC.

### 3.5 Identified units for field studies

Two industries were identified for detailed in-depth studies of the activities, visits / discussions involving consumption of chlorine and its compounds.

The industry-wise brief process description, schematic flow sheets along with model calculation of Mass Balance of PVC production and chlorine utilisation for Units PVC-1 and PVC-5 are presented at **Annexure 3.2** and **Annexure 3.3**, respectively.

#### 3.5.1 Mass Balance of Chlorine Utilisation

The data / information provided by the industry on PVC production, utilisation of chlorine, the mass balance of chlorine utilization, and estimated major sources and contributions of VCM losses for Unit PVC-1 and PVC-5-I is presented in **Annexure 3.4** and **Annexure 3.5**, respectively. The chlorine equivalent mass balance for one

tonne of PVC through Acetylene route for Unit PVC-1 and stoichiometric mass balance of PVC production through EDC route for PVC-5-1 is depicted in Annexure 3.6 and Annexure 3.7, respectively.

### 3.6 Emissions / Losses from VCM Plant

Emissions and effluents in VCM manufacturing plants occur from a balanced ethylene feedstock plant during both the manufacture and pyrolysis of EDC. Although there are solid and liquid waste streams involved in the process, the air emissions are present in larger amounts than vinyl chloride. The possible emission sources in VCM plant are:

- EDC purification residues
- VCM purification, storage and handling
- High temperature chlorination (HTC)
- EDC purification
- EDC cracking
- EDC quenching
- EDC quenching column
- Oxy-EDC treatment system
- Incineration system
- Vent scrubber
- VCM storage tank

The total quantity of emission in VCM manufacturing plant is 0.449 kg/100 kg of VCM produced. The vinyl chloride emissions from these sources is presented in Table 3.4.

**Table 3.4: Vinyl Chloride Emissions from the Balanced Ethylene Feedstock Process**

| Sl. No.      | Source                  | VCM Emissions (kg/100 kg VCM produced) |
|--------------|-------------------------|--|
| 1.           | Oxychlorination Process | 0.0364                                 |
| 2.           | EDC Purification Column | 0.05                                   |
| 3.           | VCM Finishing Column    | 0.24                                   |
| 4.           | Fugitive Emissions      | 0.1215                                 |
| 5.           | Process Water           | 0.0007                                 |
| <b>Total</b> |                         | <b>0.4486 ≈ 0.449</b>                  |

Source: Organic Chemicals Manufacturing Hazards by Goldfarb, Goldgraben, p.278

Other sources of emissions in VCM plant are :

#### Storage, Handling & Transportation Losses

- The source of VCM process emissions, after venting losses, occurs during loading operations for EDC and VCM into tank cars, tank trucks, barges or ships. These losses in VCM plant are intermittent losses.



**Unit-wise process emissions:** The unit-wise process emissions in VCM manufacturing is described hereunder :

#### **Oxy-chlorination Process Vent Gases**

- The total average emissions from the oxy-chlorination process is about 0.0364 kg/100 kg of EDC produced, the major portion comes from the oxy-chlorination process vent gas
- Significant quantities of vinyl chloride and other chlorinated hydrocarbons are also present in the vent gas

#### **Direct Chlorination Process Vent**

- The direct chlorination process produces less than one-tenth of the hydrocarbon emissions of the oxy-chlorination process and only small amounts of vinyl chloride
- It has been reported that the amount of ethylene and ethyl chloride emissions are 0.25 and 0.16 kg / 100 kg of VCM produced.

#### **EDC Purification Column Vents**

- In the purification of EDC, both continuous and intermittent venting of inert gases containing organic compounds are reported
- The total average emissions from purification column are 0.05 kg/100 kg of VCM produced.

#### **VCM Purification Column Vents**

- In the pyrolysis of EDC to produce vinyl chloride monomer, process emissions are primarily in the purification steps
- The amount of VCM and other organic compounds vented to the atmosphere varies with process design and operating conditions
- The average value of emission is 0.24 kg/100 kg of VCM produced.

**Emissions / Losses from Liquid Wastes :** Liquid wastes from the VCM process may be divided into two categories:

- i. Aqueous wash and scrubber solutions containing acids, bases, catalyst from the oxychlorination process, dissolved and suspended organics
- ii. Organic residues from purification operations

#### **i. Aqueous Liquid Wastes**

- The aqueous waste streams are usually steam-stripped to remove volatile organic compounds and then neutralized.
- The neutralized streams are sent to a settling pond to remove approximately 0.01 kg/100 kg of VCM produced of catalyst particles from the oxychlorination reactor and then to an activated sludge system for removal of non-volatile organic compounds.

## ii. Organic Residues from Purification Operations

- The organic liquid waste effluent includes light and heavy ends from EDC distillation columns and light and heavy ends from VCM distillation column
- Organic compounds in the light ends are mainly low-boiling hydrocarbons and chlorocarbons such as butane, butadiene, ethyl chloride, chloroform and carbon tetrachloride
- Organic compounds in the heavy ends are primarily highly chlorinated chlorocarbons such as tetrachloroethane, trichloroethylene, perchloroethylene, chlorinated butanes and other relatively high-boiling liquids. These heavy end streams also may be distilled to recover high-boiling chlorinated solvents
- Light end streams are estimated to be 0.42 kg/100 kg of VCM produced consisting of EDC (0.17 kg), VCM (0.08 kg) and Lightly chlorinated Hydrocarbon (0.17 kg)
- Heavy end streams are estimated to contain 0.47 kg/100 kg of VCM produced consisting of EDC (0.12 kg), Lightly chlorinated chlorocarbons (0.12 kg), and heavily chlorinated chlorocarbons (0.23 kg).

### Losses in the form of Solid Wastes

- From the balanced ethylene feedstock process, it is estimated that 0.01 kg of catalyst / 100 kg of VCM produced is discharged in the wastewater. This can be removed from the water using conventional pond settling treatment.

### Other sources of Losses / Emissions in VCM Plant

Other sources of emissions in VCM plant includes fugitive emissions are described as under:

**Fugitive Losses:** The fugitive losses are one of the major sources of emission in VCM plant. Fugitive losses of vinyl chloride for VCM plants are listed below:

| Sl. No. | Emission Source              | Emissions<br>Kg/100 kg VCM Produced |
|---------|------------------------------|-------------------------------------|
| 1.      | Pumps (includes maintenance) | 0.0243                              |
| 2.      | Valves                       | 0.001                               |
| 3.      | Relief Valve                 | 0.0008                              |
| 4.      | Cooling Water                | 0.0012                              |
| 5.      | Samplers                     | 0.0021                              |
| 6.      | Miscellaneous                | 0.001                               |
| Total   |                              | 0.0304                              |

Note: Fugitive losses are generally calculated from material balances rather than measured

The total VCM emissions to the atmosphere, fewer than 10% occur during VCM production and over 90% during PVC manufacture by batch reaction.

### 3.7 Emissions / Losses in PVC Manufacturing Plants

In India, all PVC production is based on suspension polymerisation process. The uncontrolled emissions of vinyl chloride monomer from suspension process were reported as 39.2 g/kg of PVC produced. Uncontrolled emissions of vinyl chloride monomer from the suspension process are listed in Table 3.4

Table 3.4: Uncontrolled Emissions of Vinyl Chloride from Suspension Polymerisation process

| Sl. No.      | Source                      | Contribution from Source (g/kg PVC produced) |
|--------------|-----------------------------|--|
| 1.           | Fugitive Emissions          | 15.0   |
| 2.           | Reactor Opening Losses      | 1.4  |
| 3.           | Stripper Losses             | 3.2  |
| 4.           | Monomer Recovery Vent       | 4.8  |
| 5.           | Slurry Blend Tank           | 4.2  |
| 6.           | Centrifuge Vent             | 1.3  |
| 7.           | Storage and Handling of PVC | 7.0  |
| 8.           | Reactor Safety Valve Vents  | 2.0  |
| 9.           | Process Water               | 0.25   |
| <b>Total</b> |                             | <b>39.15 <math>\approx</math> 39.2</b>       |

Source :Organic Chemicals Manufacturing Hazards by Goldfarb, Goldgraben, p.341

The possible emission sources in PVC plant are as follows:

- The emissions from the suspension polymerisation of vinyl chloride consist of vinyl chloride monomer and PVC dust in gaseous streams
- VCM storage tanks
- Polymerisation reactor
- VCM blowdown and recovery system
- Slurry stripping
- VCM vent gas recovery
- Wastewater stripping
- Slurry blend tank
- Wastewater stream contaminated with vinyl chloride monomer, PVC particles, initiator and suspending agents, and a solid waste of PVC.
- Gaseous and wastewater discharge points are reactor, separator, stripper, blend tank, centrifuge storage

Other sources of emissions in PVC plant includes fugitive emissions and losses Handling, storage and transport are described as under:

#### Handling, storage and transport losses

- In PVC manufacturing plant the major sources of emissions during Handling, Storage and Transport will occur from Vinyl Chloride Monomer Storage and Purification system
- Gaseous emissions of vinyl chloride from the storage tanks occur during loading operations and also as a result of tank breathing because of diurnal temperature variations

- Fugitive emissions can occur upstream of the storage tank during loading operations as a result of leaks in the loading equipment, which includes a compressor and a vaporizer
- Leaks can also occur at flanges and fittings in upstream and downstream piping
- The wastewater streams contain dissolved monomer that gradually would be released to the atmosphere.

#### Sources of gaseous emissions

- Process vessels and equipment when opened for cleaning and / or maintenance
- Leaks through pressure relief valves, flanges and rotating equipment seals
- Vents for non-condensable gases on the condenser in the vapour recovery system
- PVC slurry handling operations as a result of diffusion of vinyl chloride monomer that is retained by the slurry after stripping
- Wastewater handling operations as a result of evaporation of dissolved vinyl chloride monomer
- Resin drying as a result of vaporization of residual monomer in the resin
- Resin handling, storage and packaging operations as a result of the slow evaporation of residual monomer in the resin.

#### Effluent

- The wastewater from the water separator in the monomer recovery system contains dissolved hydrocarbons including vinyl chloride monomer, initiator and suspending agents.
- The wastewater from the dewatering operations would contain, in addition to the above components, some PVC resin particles.
- Wastewater is also generated from reactor cleaning operations and from plant housekeeping operations.

#### Solid Waste

- PVC particulates are emitted from operations downstream of the dewatering operation, i.e., the dryer, grinding, screening, and storage and packaging operations.
- Total particulate from the suspension process was reported to average 7.5 g/kg PVC produced.
- Solid waste consisting primarily of PVC resin is generated from reactor and pipeline cleaning operations, dust collectors, product spills and off grade product batches.
- Wastewater treatment processes may also generate solid waste as sludge.

### 3.8 Sources of Chlorine Losses in VCM & PVC Plants

Based on the information provided by the industry, through site visit and discussion with industry personnel, the mass balance of chlorine utilisation and PVC production has been studied. The major contributions of Chlorine equivalent losses in VCM and PVC Plant are estimated and presented in Table 3.5 through Table 3.7.

Table 3.5: Estimated Major Contributions of Chlorine eq. in VCM Plant

| Sources   | Contribution from sources                    |
|---|--|
| <ul style="list-style-type: none"> <li>VCM synthesis unit</li> </ul>  | Process Loss: 0.086 MT/MT VCM                |
| <b>Chlorinated waste from</b> <ul style="list-style-type: none"> <li>High chlorination</li> <li>EDC cracking</li> <li>Oxy-chlorination</li> <li>EDC Purification</li> </ul> | 0.045 MT/MT VCM<br>(Heavy ends / Light ends) |
| <b>Wastewater</b> <ul style="list-style-type: none"> <li>Oxy-chlorination</li> <li>Vent scrubber</li> <li>Floor washing</li> </ul>  | 0.04 MT/MT VCM                               |
| <b>Atmospheric vent</b><br>All vents are through scrubber   | 0.001 MT/MT VCM                              |

Table 3.6: Estimated Major Contributions of Chlorine Losses in Terms of VCM in PVC Plant

| Sources  | Contribution from sources    |
|--|------------------------------|
| <b>PVC synthesis unit</b> <ul style="list-style-type: none"> <li>VCM column</li> <li>Polymerisation reactor</li> <li>VCM blowdown and recovery system</li> <li>Slurry stripping</li> <li>VCM recovery</li> <li>Wastewater stripping</li> <li>Slurry blowdown tank</li> </ul> | Process Loss: 0.02 MT/MT VCM |

Table 3.7: Estimated Major Contributions of VCM Losses from PVC Plant (Calcium Carbide Route)

| Emission / discharge sources   | Contribution from sources      |
|--|--------------------------------|
| <ul style="list-style-type: none"> <li>VCM synthesis unit</li> <li>Compression and condensation</li> <li>1<sup>st</sup> stage distillation</li> <li>2<sup>nd</sup> stage distillation</li> <li>Vinyl chloride scrubbers</li> <li>VCM polymerisation section</li> <li>Polymeriser evacuation</li> </ul> | *Process Loss: 0.011 MT/MT VCM |
| VCM storage / handling   | 2.73 kg/day                    |
| Sub grade losses   | *0.001 MT/MT VCM               |

\* Theoretical VCM consumption for PVC production = 29,041 MT per year

### 3.9 Mimisation / Emission Control Techniques in VCM Plant

- To minimize emissions from the storage tanks, they can be vented to a vapor recovery system.
- Fugitive emissions such as leaks in the loading equipment, flanges and fittings in upstream and downstream piping can be minimized by preventive maintenance programs
- The use of double mechanical seals on rotary compressors and double outboard seals on reciprocating compressors can minimize emissions from the compressors.
- The pressure between the two seals is to be maintained so that any leakage that occurs is directed into the pump or vented through a control system.
- Stripping and recovering the monomer from the wastewater prior to treatment.
- Of the approximately 2-4% losses (based on VCM produced) of hydrocarbons, chlorinated hydrocarbons and other materials during VCM manufacture, approximately 10% is VCM (0.2-0.4 kg VCM lost per 100 kg of VCM production).
- Currently available technology may be adequate to reduce these vinyl chloride emissions from VCM plants by about 90%. Emission sources and possible methods of reducing these process emissions are presented in **Table 3.8**
- Incineration and use of oxygen instead of air in oxy-chlorination may be adequate to reduce vinyl chloride emissions from VCM plants
- Solid waste in ethylene feedstock process can be removed from the water using convention pond settling treatment.

### 3.10 Emission Control Techniques for PVC Manufacturing Plants

The control techniques that can be applied to reduce vinyl chloride emissions fall into the following categories:

- Add-on type of control systems such as absorbers, refrigeration systems or incinerators that reduce emissions from captive or point sources
- The reduction of emissions from pumps, compressors and valves through the installation of effective seals on rotating or reciprocating shafts or by enclosing the equipment
- The reduction of emissions from pumps, valves, flanges, vessels, transfer operations, piping and other processing equipment during maintenance
- The reduction of emissions by altering the manufacturing process such as adding improved stripping capacity to reduce the emissions from the slurry blend tanks, centrifuges, dryers and storage silos by reducing the vinyl chloride content of the PVC resin.

Control techniques applicable to identified vinyl chloride emission sources in typical PVC manufacturing plant are presented in **Table 3.9**.

### 3.11 Substitute to PVC & Related Products

All PVC products can be virtually replaced by less environmentally harmful alternatives, usually at competitive cost. Local governments, retailers and some industries and individuals are already replacing PVC in various applications.

Alternatives to for PVC in various applications are:

- Polyurethane (PU), Polystyrene (PS),
- Acrylonitrile-butadienestyrene (ABS),
- Polycarbonate (PC)
- Polyethylene-terephthalate (PET)
- Polyethylene (PE), Polypropylene (PP)
- Bio-based polymers

Natural materials like wood (from sustainable forestry) are a much better choice. As for the plastics economy, bio-based and biodegradable plastics hold out most promise for the future.

**Table 3.8: Emission Control Techniques**

| Source                         | Possible Method of Control                   |
|--------------------------------|--|
| EDC Purification               | Incinerator                                  |
| VCM Formation and Purification | Incinerator                                  |
| Oxychlorination Reactor        | Control process variables                    |
| Relief Valve Discharges        | Preventive measures                          |
| Fugitive Emissions:            |  |
| a. Loading Lines               | Displacement, vacuum                         |
| b. Slip Gauges                 | Incinerator                                  |
| c. Pump and Compressor Seals   | Seal-less pumps, Double mechanical seals     |
| d. Relief Valve Leakage        | Use of rupture disks                         |
| e. Manual Venting              | Use gas holder and incineration              |
| f. Opening Equipment           | Vacuum and incineration                      |
| g. Sampling                    | Purge back to process                        |
| h. Leak Detection              | Formal program for leak detection and repair |
| i. In-Process Wastewater       | Strip and incinerate                         |

Source : Organic Chemicals Manufacturing Hazards by Goldfarb, Goldgraben, p.283

Table 3.9: Control Techniques Applicable to PVC Plants

| Emission Source                                     | Applicable Control Techniques   |
|---|---|
| 1. Fugitive   |   |
| a. Transfer operations loading and unloading        | Purge to control Device   |
| b. Safety relief valve leaks and discharges         | Rupture discs flare   |
| c. Pumps, compressors and agitator seals            | Double mechanical seal  |
| d. Sampling for laboratory analysis                 | Purge sample flasks back to process   |
| e. Opening equipment for maintenance and inspection | Displace gas control device   |
| f. Vacuum pumps and steam jets                      | Vented to control device  |
| g. Process wastewater                               | Strip VCM and vent to control devices   |
| h. Leaks at flanges, seals, etc.                    | Multipoint fixed and portable monitoring devices                              |
| 2. Reactor and Stripper Losses                      |   |
| a. Safety relief valve                              | Shortstop, gasholder  |
| b. Reactor openings                                 | Displace gas to gasholder   |
| 3. Monomer Recovery System                          | Reduce inerts<br>Solvent absorber<br>Carbon absorber                          |
| 4. Slurry Blend Tanks                               | Improved stripping<br>Carbon adsorption<br>Solvent adsorption<br>Incineration |
| 5. Centrifuge                                       | Improved stripping<br>Carbon adsorption<br>Solvent adsorption<br>Incineration |
| 6. Dryers   | Improved stripping<br>Carbon adsorption<br>Incineration                       |
| 7. Storage Silos                                    | Improved stripping<br>Carbon adsorption<br>Incineration<br>Silo stripping     |

Source: Organic chemicals manufacturing hazards by Goldfarb, Goldgraben, p. 347-348



## 4.0 Chlorinated Paraffins Industry Sector

### 4.1 General

The Chlorinated Paraffins (CP) sector mostly covers small scale and unorganized units. This sector is major consumer of chlorine and about 12% of chlorine produced in the country is consumed by these units. Chlorinated paraffins belong to a group of Chlorinated Hydrocarbons of straight chain lengths  $[C_nH_{(2n+2)}]$ , where Carbon can be from  $C_{10}$  onwards. Generally, the paraffins used in manufacture of chlorinated paraffins are of  $C_{10}$  to  $C_{24}$  which corresponds to Normal and Heavy Normal Paraffins and Waxes.

Chlorine content in Chlorinated Paraffin ranges from 20% to 70% depending on its application. However, in India, chlorinated paraffin manufactured has 40-70% chlorine content and is in the liquid state. The major applications of Chlorinated Paraffins with its grades and properties, applications and advantages are presented in Annexure 4.1.

### 4.2 Status of Chlorinated Paraffins Industry

The Small Scale Industries (SSI) and large / medium scale units that are engaged in the production of chlorinated paraffins mainly located in North and West parts of India. At present there are about 100 Small Scale units and 10 -15 large/ medium scale units manufacturing chlorinated paraffins & chlorinated paraffin wax with a total installed capacity of 3,00,000 tonnes per annum. More than 10 among these units produce both chlorinated paraffin and chlorinated paraffin wax. All the CPW industries are based on batch process technology. The installed capacity of Indian CPW industry has grown to 3 lakh tonnes while the production is between 1.0 lakh and 1.1 lakhs tonnes i.e. only 35% of installed capacity.

The small-scale units manufacturing chlorinated paraffin wax usually pass chlorine through molten paraffin wax in agitated reaction vessels. Usually such small-scale units used to vent hydrochloric acid gas and unabsorbed chlorine into the atmosphere in the past. The chlorinated paraffin manufacturers subsequently installed suitable scrubbers for recovery of hydrochloric acid.

### 4.3 Manufacturing Process

Normal / Heavy Normal Paraffins (HNP), being straight-chain saturated hydrocarbons (alkanes) react with chlorine readily, replacing hydrogen atoms to produce Chlorinated Paraffin and Hydrochloric Acid.

The reaction is exothermic:

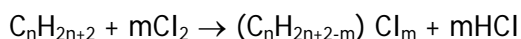

The batch type of production method is preformed in view of the following reasons:

1. Scale of operation is small (4 to 5 MT per batch) and mostly produced in the SSI sector.
2. The grades are many and sometimes tailor made and application oriented.

#### 4.4 Production and Estimated Demand of CPW

The production of CPW was 82,000 T in 1996-97; 90,000 T in 1997-98; 1,00,000 T in 1998-99 and 1,10,000 T during 1999-00.

The demand for CPW production is expected to grow @ 7.5% per annum and at this rate the projected demand would be 2,26,714 tonnes in 2009-10. It is reported that the import of Chlorinated Paraffin is in negligible.

#### 4.5 Chlorine Consumption and Estimated Demand in CPW

Theoretically 1.05 T of chlorine is required to produce one ton of CPW. The consumption of chlorine was 86,000 T in 1996-97; 94,500 T in 1997-98; 1,05,000 T in 1998-99 and 1,15,000 T in 1999-00. The installed capacity, CPW production and chlorine consumption in CPW for the period 1996-97 to 1999-2000 is depicted in Fig. 4.1. The consumption of chlorine in CPW sector is expected to be about 2,38,050 T in 2009-10 against the CPW production of 1,57,919 T and 2,26,714 T during the same year.

Figure 4.1: Installed Capacity, CPW Production and Chlorine Consumption in CPW

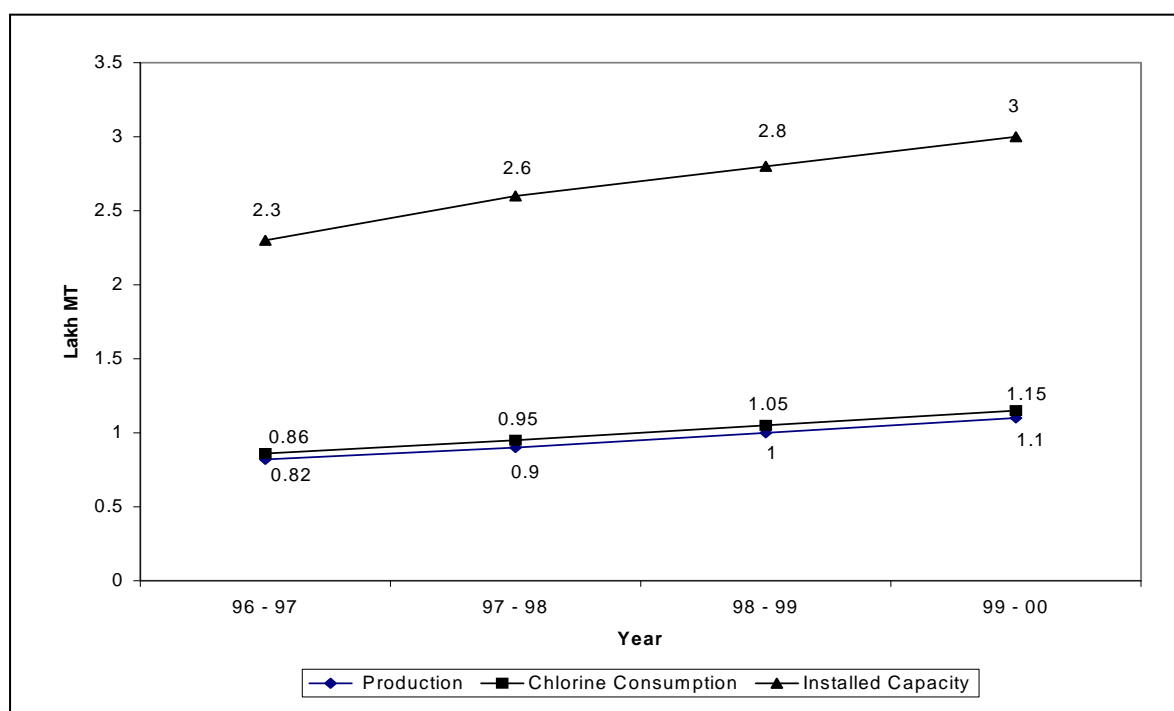

#### 4.6 Identified Industries

The information was obtained from CPW producing units through President, Nandesari Industries Association (NIA), Nandesari, Vadodara. After reviewing the information, the three CPW industries from GIDC, Nandesari were identified for detailed in-depth studies of the activities, visits / discussion involving chlorine and its compounds.

On the basis of information provided by the units, site visits and discussion with the industry personnel and President, NIA on CPW production, chlorine utilisation and its

mass balance has been studied for all the three CPW producing industries. The unit wise process description and schematic flowsheet along with model calculation (theoretical and actual situation in industry) on mass balance of chlorine utilisation is presented at Annexure 4.2 through Annexure 4.4.

#### 4.6.1 Mass Balance of Chlorine Utilisation

The stoichiometric Mass Balance of chlorine utilisation in CPW manufacturing is presented here under :

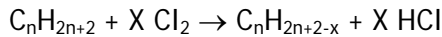

Chlorine reacts with paraffin to produce Chlorinated Paraffin & HCl. Considering the consumption per unit of Chlorinated Paraffin (CP)

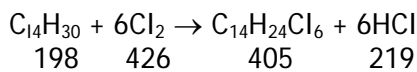

Heavy Normal Paraffin (HNP) =  $198 / 405 = 0.488$  units per unit of CP

Chlorine =  $426 / 405 = 1.05$  units per unit of CP

1.05 units of chlorine required to produce one unit of CPW (batch process).

Considering the production per unit of chlorine,

Chlorinated paraffin =  $405 / 426 = 0.95$  units per unit of chlorine  
 HCl =  $219 / 426 = 0.51$  units per unit of chlorine

Chlorine content in CPW =  $(\text{mass of chlorine} - \text{mass of HNP}) / \text{mass of CPW}$   
 =  $(426 - 198) / 405 = 56.29\%$

Chlorine equivalent of CPW for 0.95 unit =  $\frac{0.95 \times 213}{405} = 0.499$

Chlorine equivalent of HCl for 0.51 units =  $\frac{0.51 \times 35.5}{36.5} = 0.496$

Process losses = input - output =  $(1.05 + 0.488) - (0.95 + 0.51)$   
 = 0.078 per unit of input

Per cent loss =  $(0.078 / 1.538) \times 100 = 5.07$

56.29% chlorine (0.499 chlorine eq.) is utilised by paraffin to produce one unit chlorinated paraffin and remaining chlorine gas can be used to produce HCl gas. At the end of reaction, unabsorbed chlorine escapes through vent gases. In case, the unreacted chlorine and HCl vapours are not utilised to produce HCl, due to no demand of HCl and the scrubbers provided are not put into operation by the industry, all the chlorine in the form of HCl vapours is vent out. Unreacted chlorine and HCl vapours escape to the atmosphere if scrubbers are not installed / non-functional. However, taking into account handling and process losses of HNP, Cl<sub>2</sub>,

HCl and CP, the per cent yield of output vs input is around 95%. The unaccounted handling and process losses will be 5%.

Mass Balance:

$$\begin{aligned} \text{Input} &= \text{Output} + \text{Losses} \\ 1.538 &= 1.46 + 0.078 \end{aligned}$$

The stoichiometric mass balance of chlorine for CPW production is presented in Fig. 4.2 and can be used to arrive at the yield and losses in manufacturing process.

Figure 4.2: Stoichiometric Mass Balance of Chlorine for CPW

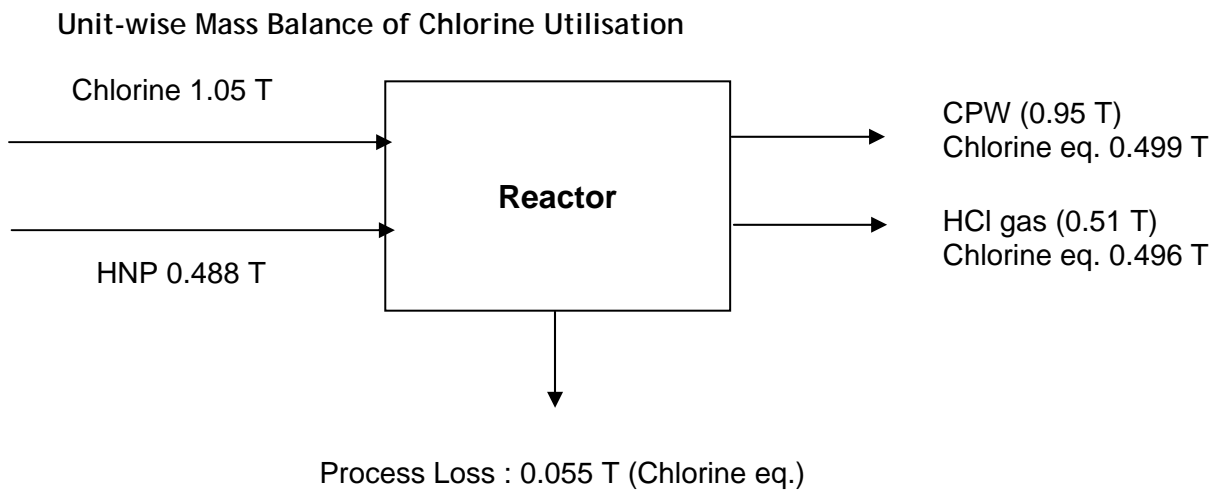

Based on the questionnaire information and through site visits to industries as well as discussion with industry personnel, industry-wise mass balance of chlorine utilisation has been studied. The data provided by units CPW-I, CPW-II, and CPW-III on CPW and HCl production and chlorine consumption alongwith summary of mass balance of chlorine utilisation for the period (1996-2001) is presented in Annexure 4.5 (Tables 4.1 through 4.3) respectively. The chlorine equivalent mass balance for

the production of one tonne of Chlorinated Paraffin at unit CPW-I is presented in Figure 4.3.

#### 4.7 Emissions of Chlorine

For one tonne of CPW, 1.05 tonnes of chlorine is required by batch process. It is reported that out of these 1.05 tonnes of chlorine only 50-70% chlorine is utilised by paraffin to produce chlorinated paraffin and remaining chlorine gas is used for production of HCl gas. At the end of reaction, considerable amount of unabsorbed chlorine escapes through vent gases. If the scrubber system is not available or not in good operating conditions, all this chlorine in the form of HCl vapours is vented out or lost in atmosphere.

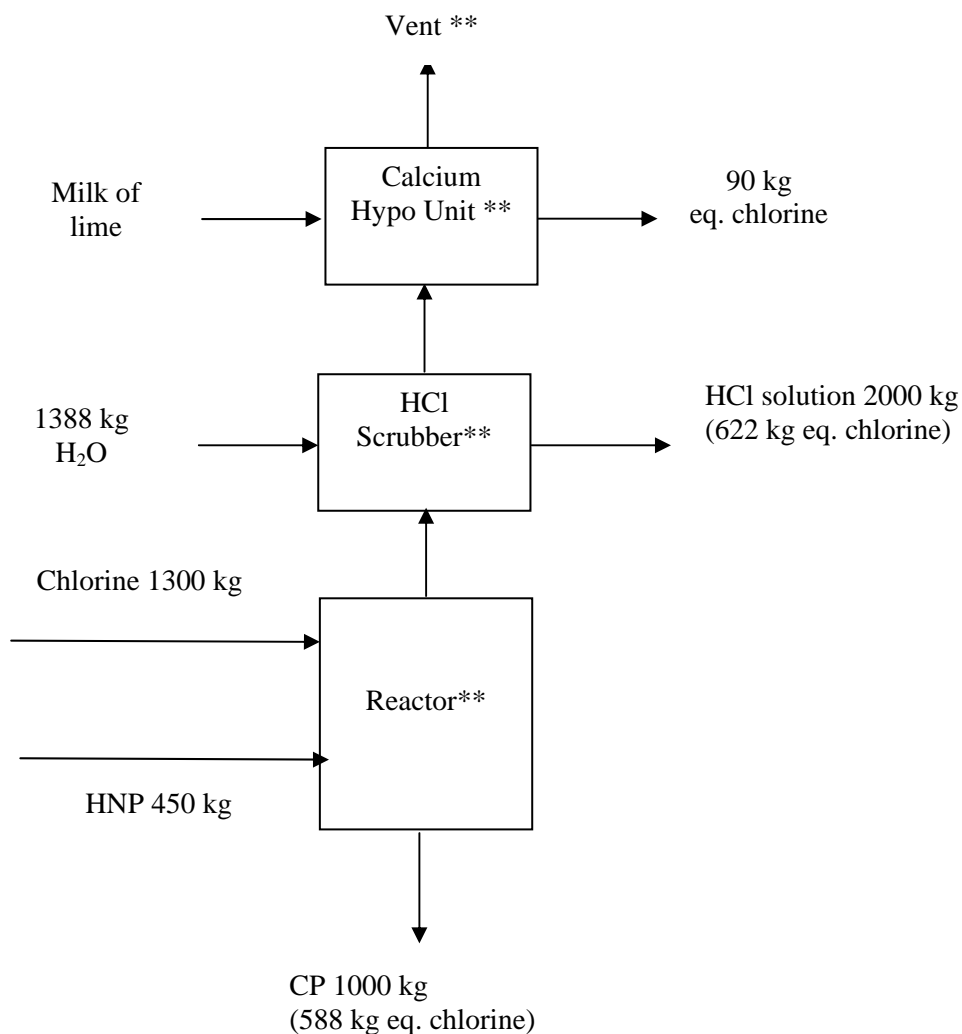

\*\* Possible Emission Source

**Figure 4.3 : Chlorine Equivalent Mass Balance for One Tonne of Chlorinated Paraffin**

#### 4.7.1 Emission Sources

- Chlorine delivery system (cylinder connection / disconnection from the header)
- Reactor (unreacted chlorine and HCl vapours)
- Cyclone separator
- HCl scrubbing system
- Chlorine scrubbing system (calcium hypo unit)
- Finished product
- HCl gas and unabsorbed chlorine through vent gases
- HCl storage / disposal
- Miscellaneous (pipes, pipe joints, flange joints and valves)

Losses from storage vents, safety and relief valves, pump maintenance and vessel opening for inspection are included in fugitive emissions. The storage, handling and transport losses occur during loading operation of CPW in tank or tankers. Emissions from loading operation are negligible.

#### 4.7.2 Major Contributions of Chlorine Losses

The small-scale units manufacturing chlorinated paraffin wax usually pass chlorine through molten paraffin wax in agitated reaction vessels. Usually such small-scale units used to vent hydrochloric acid gas and unabsorbed chlorine into the atmosphere. The major sources and estimated losses of chlorine is presented as under :

| Sources                    | Estimated Losses            |
|----------------------------|-----------------------------|
| Chlorine emissions         | (kg/T of chlorine consumed) |
| • Chlorine Delivery System | 3 - 5                       |
| • Reactor                  | 5 - 7                       |
| • Scrubber                 | 1 - 2                       |
| • Cyclone Separator        | 2 - 3                       |
| • Hypo Unit                | 90                          |
| • Chlorine Vent            | 10 -15                      |
| HCl Emissions              | Kg/T of HCl produced        |
| • Reactor                  | 10 - 15                     |
| • Cyclone Separator        | 8 - 10                      |
| • HCl Scrubber             | 15 - 20                     |
| • Tail Gas Vent            | 8 - 10                      |

#### 4.8 Emission Control Techniques

##### Emission control measures

- Two stage chlorine absorption system: The HCl vapours should be scrubbed by adopting two stage chlorine absorption system to absorb unreacted chlorine and HCl vapours, thereby chlorine in the form of HCl and unreacted chlorine do not escape to the atmosphere

- HCl vapours should be recovered by using HCl scrubbers
- Preventive maintenance measures

#### Handling of Chlorine / HCl Leakages

- The chlorine gas header should be de-pressurised into a caustic pit while changing chlorine cylinder to minimise even traces of chlorine vented into atmosphere.
- The loss of chlorine is possible, if chlorine is not drawn through a rotameter and a barometer leg before feeding into the reactor. Chlorine loss can be avoided by monitoring continuous chlorine flow and back flow of paraffin from the reactor.
- The on-line chlorine monitors may be provided in and around plant premises. The chlorine / HCl leakages can be reduced by providing chlorine gas detectors nearby chlorine emission sources
- Unreacted chlorine and HCl vapours through vent can be handled by installing/operating chlorine neutralisation system
- The emission through pipes, pipe joints, flange joints, and leakages in gear pumps and valves etc. should be avoided by preventive maintenance
- The manufacture of chlorinated paraffin does not generate wastewater. Hence, there is no loss of CPW or chlorine through the effluent. However, Chlorinated Paraffin should be protected from water contamination. Wastes containing short chain Chlorinated Paraffin have been found to be bio accumulating. These wastes may therefore lead to environmental hazards in case not properly disposed.
- In case of transfer of CPW into the storage tank the loss is possible in case of gear pumps failure
- The process of CPW involves the use of chlorine and handling of HCl, the emissions are possible if the efficient absorption of HCl to produce commercial HCl system is not properly operated.

#### 4.9 Areas for Minimisation of Emissions

The following sources / areas are identified where major contributions of chlorine losses can be avoided:

- Chlorine delivery system (cylinder connection / disconnection from the header)
- Reactor opening and closing (unreacted chlorine and HCl vapours)
- Cyclone separator
- HCl scrubbing system
- Chlorine scrubbing system (calcium hypo unit)
- HCl gas and unabsorbed chlorine neutralisation system is in proper condition / functioning
- HCl gas and unabsorbed chlorine through vent gases
- HCl storage/disposal vents and HCl market availability / demand

#### 4.10 Alternative to CPW

- The major alternative in place of CPW in plastic industry is oxy-alcohols. Which is used as flame retardant and secondary plasticizer, and are incorporated in plastic rubber.

- Replacement of chlorine radical by bromine radicals, which are less toxic to human health.
- Aluminium, synergistically used with chlorinated paraffin to reduce smoke density and toxicity.



## 5.0 The Pulp and Paper Sector

### 5.1 General Status

Paper Industry represents an important segment of the Indian economy. The first paper mill in the country was established in Serampore, West Bengal in 1932. As per annual review by Asia / Australia, July 1, 2001, India has per capita consumption of 4.1 kg. India's total paper and paperboards requirement forms a marginal 1.25 per cent share in the global market. The average per capita paper consumption in Asia (18 kg) is six times higher than that of India. The paper industry in India is primarily tree-free as paper products cater 62% of the market from non-conventional raw materials like agro-waste, agro-residues and recycled paper. However, majority of paper mills use (63.4%) waste paper as a raw material. They account for 30.1% of the total paper manufactured in the country.

The pulp and paper industry is segmented as wood/forest-based, agro-based and waste paper based with the former accounting for 43%, agro-based inputs 28%, and the rest 29% on waste paper. The pulp and paper mills are further classified as those having an installed capacity of 24,000 tonnes per annum (TPA) and above (large scale); less than 24,000 tonnes but greater than 5,000 TPA (medium scale) and 5000 TPA and below (small scale). There are 406 pulp and paper units with 36 in the large-scale sector and 370 in the medium and small-scale sector with an installed capacity of about 64 lakh tonnes. There are 131 units with 32 lakh tonnes capacity manufacturing only pulp. The capacity utilization is around 60-65 per cent of the total installed production capacity.

Small paper mills mainly based on wastepaper contribute very little towards pollution. Many of the medium scale paper mills based on the agro raw material producing writing, printing and variety of paper which are without chemical recovery plant contribute heavily towards pollution because of the organics generated during pulping and washing and also due to the chloro organics generated during bleaching of pulp. Large paper mills are based on wood, bamboo and agro raw material, well equipped with the chemical recovery, contribute towards pollution mainly due to the chloro organics formed during bleaching operation.

### 5.2 Technology Status

The pulping process practiced in wood-based pulp and paper mill is the Kraft sulfate process. In the agro-based pulp and paper mills, the soda process using caustic soda for the cooking is mainly used.

The major pollution and environmental problem faced by the pulp and paper industry is high concentration of oxygenated halogens in the effluent due to chlorine bleaching. Most of the paper units practice the conventional chlorine based bleaching process. The bleaching sequence involves chlorination, alkali extraction and hypochlorite treatment. The effluent generated from the bleaching section contains oxygenated halogens and other associated compounds that are known carcinogens. The bleaching section generally poses the problem of fugitive emissions in the form of chlorine and other chloro organic compounds. The problems of pollution control are more dominant in the small-scale pulp and paper sector, largely due to outdated processes and inadequate pollution prevention and control technologies.

### 5.3 Production of Paper Growth and Demand

The country's paper industry in 1999-00 had a installed capacity around 51 lakh tonnes as against 38 lakh tonnes in 1994-95 spread over 406 units in organised sector.

Of the total demand for various varieties of papers, the share of cultural paper (writing & printing) and industrial paper was 46% and 48% respectively, and the rest is specialty paper.

The production of paper in 1996-97 was 42.06 lakh tonnes. The production of paper and pulp is estimated around 6 million tons in 2009-10 at the growth rate of 6.5%.

### 5.4 Pulp and Paper Manufacturing process

The manufacturing of pulp & paper involves several unit-operations such as raw material preparation, pulping, pulp washing, pulp bleaching and paper making out of which bleaching is most important process. The pulp is treated with bleaching agents, viz. chlorine, hypochlorite and chlorine dioxide are the most frequently used. The manufacturing process is shown in **Annexure 5.1**.

### 5.5 Chlorine Consumption in Pulp and Paper Industries

The Pulp & Paper industry is the major consumer of chlorine in India. Consumption of chlorine is 5.5% and 6% of pulp product for extraction and bleaching stages respectively.

The chlorine consumption in 1996 - 97 was 1,60,000 T. The chlorine consumption is expected to grow by CAGR of 2.5 %. Assuming 1,82,000 T in 2001-02, the chlorine consumption is expected to be 2,20,561 T in 2009-10.

### 5.6 Formation of Organochlorine during Chlorine Bleaching

In India, the kraft process is mostly used for pulping in pulp and paper mills which are wood based. The chemical pulp is generally bleached using a multistage process of three to six steps, depending upon the pulp characteristics. Chlorine and chlorine dioxide are mostly used during bleaching. In bleaching elemental chlorine reacts primarily with residual lignin to produce approximately 4 kg of organically bound chlorine per tonne of pulp produced. This may vary according to the quality of the pulp (kappa number) being bleached and the specific bleach sequence. About 70% of the organically bound chlorine is present as high molecular mass material in spent liquor from the bleach. In the extraction liquor about 95% is consumed in the formation of high molecular mass compounds with high carbon to chlorine ratios. These are biologically and toxicologically inactive. Around 30% of the organically bound chlorine is found in the spent chlorination liquor and 5% in the alkali extraction liquor as compounds of low molecular mass. Quantitatively, the most important is trichloromethane, which may be produced in quantities up to 40 g per tonne of produced pulp. Trichloroethene, pentachlorobenzene and dichlorophenol are also produced in significant quantities together with a number of chlorinated phenolic compounds.

Chlorinated phenols are known precursors of the polychlorinated dibenzo-p-dioxins (PCDDs) and the dibenzofurans (PCDFs). In addition to the chlorophenolics derived from wood, oil based defoamers have also been identified as precursor materials. The most toxic congener formed during chlorine bleaching is 2,3,7,8-tetrachlorodibenzo-p-dioxin.

#### 5.6.1 Chlorine & Chlorine dioxide Linkage during Bleaching

Elemental chlorine used during bleaching of pulp is the main source of organically found chlorine in effluent. Elemental Chlorine Free (ECF) is the process of pulp bleaching, which does not use chlorine gas. Even if the elemental chlorine is totally replaced during bleaching, by chlorine dioxide, elemental chlorine may enter into bleaching sequence with which is produced as co-product in the manufacture of chlorine dioxide. A portion of it is absorbed in the scrubbing tower and used to prepare the bleaching solution. The remaining part goes with chlorine dioxide to bleaching plant.

In the R2 process for the manufacture of chlorine dioxide around 0.67 T of chlorine per tonne of chlorine dioxide produced. Approximately 1 g/L is in the chlorine dioxide solution while the balance is used to manufacture hypochlorite. Free chlorine is also generated during bleaching with chlorine dioxide. Chlorine dioxide reacts with the pulp to produce bleached pulp and chlorous acid. The concentration of chlorous acid becomes lower with increase in pH value. Chlorous acid is reduced to hypochlorous acid in the course of the reaction. In the presence of chloride ion, the hypochlorous acid enters into another pH dependent equilibrium with free chlorine being evolved. This free chlorine is available to produce chlorinated organic compounds measured as AOX. Hence, "elemental chlorine free", where this means "molecular chlorine free" is not true of any bleach sequence involving chlorine dioxide. Therefore, only those commercial processes entirely free of chlorine chemicals as bleach agent merit the term of elemental chlorine free.

#### 5.7 Minimisation of Organo-chlorine formation through Process Modification

The most polluting part in paper industry is the effluent generated during the pulping and bleaching. In order to make the paper industry environment friendly, it is therefore necessary to reduce the effluent load through improvement in pulping and bleaching processes. The technologies developed to improve the pulp quality are:

- Continuous pulping
- Extended delignification (Oxygen- alkali digestion, RDH, Superbatch etc.)
- Urea pulping
- Organosolve pulping (Organocell, alcell, ASAM etc.)
- Peroxyacid pulping (Milox process etc.)
- Enzymes pulping

Continuous pulping is very encouraging for energy saving and uniform production of pulp. Extended delignification in the digester by Rapid Displacement Heating (RDH) is effective in energy saving and pollution load reduction. It requires heavy capital investment in its implementation. It is reported that one paper mill uses RDH method for extended delignification during pulping and consumes less bleaching chemicals and water. It consumes 12.2 kg of elemental chlorine per tonne of paper produced which is less as compared to most other mills which consumes about 100 kg or more than that. Urea pulping is an environmental friendly pulping option for

producing unbleached grade papers with the advantage of using sodium free pulping spent liquor for irrigation purpose. Organosolve, Peroxyacid and Enzyme pulping are in developing stage and are not being applied widely on commercial stage. The pre bleaching treatment results in reduction of pulp kappa before bleaching. It reduces bleach chemical demand and effluent load. It includes:

- Enzymatic pretreatment
- Oxygen Pre-bleaching
- Alkaline leaching in presence of hydrogen peroxides
- Alkaline leaching using sodium hydroxide

The detailed information on pulping and pre-bleaching processes is presented at **Annexure 5.2**.

## **5.8 Environmental Problems**

### **5.8.1 Emissions of Chlorine**

The different pollutants, viz. odorous compounds, SO<sub>2</sub>, Chlorine compounds, NO<sub>x</sub> and particulates are being emitted from various stages of manufacturing process in pulp & paper industry. The main source of emission of chlorine and compounds is the bleaching process. Chlorine compounds are also emitted in small amounts from the lignin dissolving bleaching process. The emissions are mostly of fugitive which means that the emissions are not located to any particular point source but originate as fumes from tank vents, wash filters, sewers etc. These gases are chlorine or chlorine dioxide.

### **5.8.2 Discharge of Organochlorine Compounds in Effluents**

During bleaching, elemental chlorine reacts primarily with residual lignin to produce approximately 4 kg of organically bound chlorine per tonne of pulp produced. This may vary according to quality of pulp (kappa number) being bleached as described in Section 5.6.

According to information collected from a paper mill identified for in-depth study, about 90% of the chlorine used in the pulp bleaching process react to produce sodium chloride a clearly inoffensive inorganic compound. A very part of the remaining 10% forms chlorinated molecules that are toxic persistent and bio-accumulate.

The average total organochlorine (TOCL) discharge per tonne of paper produced from Indian paper mills is estimated to be 2 to 10 kg/tonne of paper, while most developing countries aim to achieve a TOCL level of 0.1 to 1.0 kg/tonne of paper. Furthermore, because TOCL enters the food chain and does not degrade easily, it is difficult to determine any safe level of organochlorine discharge. In India, permissible TOCL level for large and medium units is 1.0 kg/tonne with effect from April 1, 2008.

## **5.9 Identified units for Field Studies**

One paper mill was identified for detailed in-depth studies of the activities, visits / discussion involving chlorine and its compounds in bleaching of pulp during

manufacturing process of paper. The brief process description is detailed at Annexure 5.3.

#### Production capacity of the paper mill studied in depth

| Description        | Production in 2000-01 (MT) |
|--------------------|----------------------------|
| Writing & printing | 64878                      |
| Paper board        | 2962                       |
| Tissue paper       | 4962                       |
| Total              | 72802                      |

#### 5.9.1 Mass Balance of Chlorine Utilization

Based on the information provided by the mill and through site visits to industry as well as through discussion, the mass balance of chlorine utilisation has been studied.

The information collected through questionnaire on consumption of raw materials used in the pulp and paper mill studied in-depth and the production of various types of paper during 1996-2001 is presented in Table 5.2. The consumption of chlorine and its compounds during pulp processing for bleaching for 1996-2001 is presented in Table 5.3. The uncontrolled chlorine losses from the raw materials used and consumption of chlorine and its compounds during the process for the year 2000-2001 is presented in Table 5.4. The estimated emission / discharge of chlorine concentration and quantity of effluent / waste generated during the process is presented in Table 5.5.

Table 5.2: Raw materials used in the paper mill (2000-01)

| Raw Material | (Tonnes / year) | Chlorine required / T of material | Chlorine loss / T of material | Paper produced / T of raw material |
|--------------|-----------------|-----------------------------------|-------------------------------|------------------------------------|
| Bamboo       | 113969          | 0.05011 T                         | 0.0089 kg                     | 0.399 T                            |
| Wood         | 68393           |                                   |                               |                                    |
| Pulp         | 834             |                                   |                               |                                    |

Table 5.3: Consumption of Chlorine / its Compounds in the paper mill studied

| Description          | Consumption 2000-01 (MT) |
|----------------------|--------------------------|
| Chlorine             | 5121                     |
| Chlorine dioxide     | 268.8                    |
| Calcium Hypochlorite | 3759                     |
| HCl                  | 30                       |
| Total                | 9178.8                   |

**Table 5.4: Mass Balance of chlorine used in bleach plant in the paper mill**

|   |           |
|---|-----------|
| Total raw material used                     | 183196 T  |
| Total chlorine consumed                     | 9179 T    |
| Chlorine required @ 0.05011 T/T of material | 9180.63 T |
| Loss of chlorine                            | 1.63 T    |
| Chlorine loss/T of material                 | 0.0089 kg |

**Table 5.5: Estimated Chlorine in Effluent / Emission in the paper mill**

| Emission / Discharge Source   | Chlorine Concentration   | Total quantity of effluent / slurry | Quantity of chlorine in effluent (T / year) | Remarks   |
|---|--|-------------------------------------|---|---|
| Effluent <ul style="list-style-type: none"> <li>Chlorine bleaching</li> <li>Hypochlorite bleaching</li> <li>Chlorine dioxide bleaching</li> </ul> | Average 10 ppm (Before final treatment with alkaline effluent) | 4500 m <sup>3</sup> /day            | -   | The wastewater generated from the bleach plant is finally treated with alkaline wastewater of other section of the mill, where any residual chlorine is completely neutralised and the final discharge wastewater does not contain any free chlorine. |
| Chlorine produced in chlorine dioxide plant   | 0.6 T / tonne of ClO <sub>2</sub> produced                     | -                                   | -   | Chlorine produced is absorbed in Milk of lime and hypo thus prepared is used in process.  |
| Slurry from hypochlorite Settler  | 50-55 kg/day (Avg. 52.5 kg/day)                                | -                                   | -   | The Under flow slurry from the Hypo Settler which contains approx. 20-25% of Hypo is sent to ETP and used for de-colourisation of the effluent. This hypo reacts with the alkaline wastewater completely and there is no free chlorine left.          |
| Uncontrolled emissions through various vents in pipe line   | Traces   | -                                   | 1.63  | This mainly contains unabsorbed Cl <sub>2</sub> from the Chlorine Scrubber of ClO <sub>2</sub> plant in traces (approx 1% of quantity shown in item No.2) (0.6 T/T of ClO <sub>2</sub> x 268.8 T of ClO <sub>2</sub> /year x 1% = 1.63 MT/year)       |

The total quantity of chlorine losses observed was 1.63 T in 2000-01. The estimated chlorine loss per tonne of paper is 0.0089 kg.

#### 5.10 AOX Discharge Limits

Most countries have specified the maximum discharge limit for AOX or TOCl in mill effluent. A typical example is the Swedish TOCl standard of 0.10 kg/t by the year 2010.

In the convention held in Paris for the prevention of pollution from land based sources & rivers, the AOX limit in general was set at 1.0 kg/t effective from 1995 to all types of bleached chemical pulp mills. The proposed AOX limit in general has

been accepted by Belgium, Denmark, France, Germany, Ireland, Luxemburg, The Netherlands, Norway, Portugal, Spain, Sweden and U.K.

Based on studies conducted by Central Pulp & Paper Research Institute (CPPRI), Saharanpur on Assessment of AOX level in Indian Pulp and Paper Industry, the Central Pollution Control Board (CPCB) has finalized the permissible limits of AOX in paper mill effluents. The permissible limits of AOX in various countries is presented in Table 5.6

**Table 5.6: Regulation for Discharge of AOX (Kg/T)**

| Country   | 1994       | 1995-2000 | 2000-2005  |
|-----------|------------|-----------|------------|
| Australia | 1.0        | -         | -          |
| Austria   | 0.76 - 1.5 | 0.5 - 1.0 | -          |
| Canada    | 1.5        | -         | 1.0        |
| Germany   | 1.0        | -         | -          |
| India     | 2.0        | 2.0       | 1.5*       |
| Japan     | 1.5        | -         | -          |
| Norway    | 1.0 - 2.0  | -         | -          |
| Sweden    | 1.2 - 1.5  | 0.3 - 1.0 | 0.3 - 0.50 |
| USA       | -          | 0.62      | -          |

\* Permissible limit is 1 kg/T w.e.f. April 1, 2008

### 5.11 Substitute Chemicals for Elemental Chlorine

The thrust of new environment friendly plants is replacement of chlorine with ClO<sub>2</sub>, which achieves ECF (Elemental Chlorine free) status rather than TCF (Total chlorine free) status. The substitution of elemental chlorine (Cl<sub>2</sub>) does not eliminate organochlorines completely but their formation is reduced. ECF processes are not free of elemental chlorine. Commercial chlorine dioxide generators co-generate molecular chlorine. Moreover, chemical reactions and pH dependent chemical equilibrium in pulp bleaching reactions involving chlorine dioxide liberate molecular chlorine. This molecular chlorine then reacts with chemicals released from the wood. Organochlorine production in ECF processes is in the range of 0.1-10.0 kg per tonne of air dried pulp produced. The greater the degree of chlorine dioxide substitution and early delignification, the better is the effluent quality achieved. By substituting chlorine with chlorine dioxide bleaching the organochlorine can be reduced from 13 kg/T to less than 5 kg/T. Chlorine dioxide is applied in solution upstream of the chlorine charge. The substitution rate range from 5 to 100% of the elemental chlorine. High substitution rates (>70%) are most effective for decreasing production of chlorinated compounds. Dioxin and furan levels dropped to below detection limits at 75% chlorine dioxide substitution. At 85% substitution, AOX final effluent levels dropped from 5.0 to 1.5 kg per tonne of pulp bleached and average chloroform generation dropped to less than 0.045 kg per oven-dry tonne of pulp. Chlorine use can be significantly reduced, and the formation of associated chlorinated by-products is proportionately reduced. These modifications, however, require changes in process equipment and will increase the investment and the operating costs.

The complete elimination of organochlorine discharges can be achieved by the use of TCF (Totally Chlorine Free) bleaching where chemicals such as hydrogen peroxide and ozone are used. A necessary prerequisite of TCF bleaching is a pulp with low residual lignin (kappa number) produced through extended cooking and oxygen delignification. Conversion of existing mills favours this technology over chlorine dioxide based processes in economic terms.

During oxygen delignification, cellulose degradation by oxygen led to substantial yield losses and inferior pulp strength. Later on, magnesium compounds play an important role in preserving the strength of the oxygen-bleached pulp by inhibiting the carbohydrate degradation. This attributed to the key success of oxygen bleaching technology. The most significant benefit of oxygen bleaching technology is the reduction in effluents pollution load. An additional advantage of oxygen bleaching is chemicals saving. This can also reduce capital and operating costs while producing good pulp quality.

Ozone is used as the primary bleaching agent instead of chlorine, following oxygen delignification. In addition to eliminating the formation of undesirable chlorinated compounds, ozone bleaching also facilitates the recovery of ozone and extraction stage filtrates in the chemical recovery system. This method significantly reduces wastewater discharge loading of AOX, BOD and color from the bleach plant.

Hydrogen peroxide has entirely replaced chlorine for bleaching of newsprint. This is due to the fact that fibres in newsprint pulp get affected by chlorine and its use would lead to lesser yield when compared to peroxide. Better yield compensates for higher cost of peroxide. Small amount of  $H_2O_2$  is used in pulp manufacturing to impart "final" whiteness. Considerable reduction in the discharges takes place from the bleach section when hydrogen peroxide is used as bleaching chemical. The quantity of effluents is reduced by 11.8%, COD by 18% and BOD by 33.3%. There is an improvement in the quality of pulp. Elimination of chlorine from bleaching and AOX from the effluents is an added advantage of hydrogen peroxide bleaching.



## 6.0 Organic Chemicals Industry Sector

### 6.1 General Status

The basic organic chemical industry constitutes a major segment of the country's economy. Important chemicals in this category are chloro-organic compounds. These are raw materials for industries like plastic, drugs, pharmaceutical etc. Chlorine is used for the manufacture of Several Organics. The various chloro-organic segments are as follows:

- Chloromethanes
- Chlorobenzenes
- Chloroethanes
- Propylene, (Cholorohydration)
- Epichlorohydrin
- Monochloro Acetic Acid
- Others
  - Pesticides
  - Pharmaceutical

### 6.2 Chloromethanes

Chloromethanes exist in four forms with different levels of chlorination as mentioned below :

#### Methyl Chloride

- Major uses are
  - Pesticides
  - Quaternary salts

#### Methylene Chloride

- Major uses are
  - Solvent in drug Manufacture
  - Foam Manufacture

#### Chloroform

- Major uses are
  - Hydro-chloro Furans (HCFs)
  - Pharma Solvent

#### Carbon Tetrachloride

- Major uses are
  - Chloro-fluoro-carbons (CFCs)
  - Pharma Solvent

In chloromethanes, chlorination is carried out in sequence and hence, chlorination with a lower level of chlorination is an intermediate product for the higher one. Chloromethanes contain a higher extent of chlorine and is being manufactured in organised sector. There are four manufacturers of chloromethanes. The total installed

capacity and production of chloromethane for 1996-97 in these four industrial units were 66800 Tonnes and 52000 Tonnes, respectively.

### 6.2.1 Manufacturing Process

The basic raw materials for manufacturing chloromethanes are methane and chlorine. Methane is available from petroleum product producing industries and also imported from western countries. Generally, the industrial plants are designed for producing mixed chloromethane, viz. methyl chloride (CH<sub>3</sub>Cl), methylene chloride (CH<sub>2</sub>Cl<sub>2</sub>), chloroform (CHCl<sub>3</sub>) & carbon tetrachloride (CCl<sub>4</sub>). All these products are temperature dependents. The unit operations in manufacturing processes are as follows:

- Thermal Chlorination
- HCl Removal
- Gas Treatment
- Gas Compression & Liquification
- Pure Gas Treatment
- Distillation
- Photochlorination & Neutralisation
- Product Storage & Handling

Reactions are:

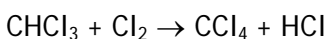
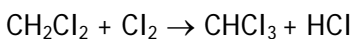
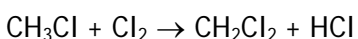
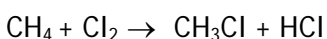

These are free radical chain reactions and are exothermic in nature.

### 6.2.2 Production and Demand Growth

The production of chloromethane was 60,765 T in 1999-00 and 71,008 T in 2000-01.

#### Future Scenario for Chloromethanes

The future production / demand of chloromethane depends on the growth of individual product, as they are used in different end use products and coming new capacities and expansions as well as the growth in domestic and international market.

**Methyl Chloride** : Major application pharmaceutical and growing by 8-9% per year.

**Chloroform** : Expected to grow impressively particularly on account of Hydro-chloro-fluoro-carbon (HCFC) replacing CFCs and potential for HCFC expected to grow by 12% annually.

**Carbon Tetrachloride** : Major end use (CFC) to be phased out by 2010 as per Montreal protocol. However, in next years no stagnation / drop is expected and the expected growth is 5% per annum.

By considering all above, the growth of individual products and other factors, the future demand for chloromethane is expected to grow @ 8.1% per annum. At this rate the demand is expected to rise to 1,43,151 T in the year 2010.

The current installed capacity of 67,000 T will be inadequate to meet the demand for the year 2010.

### 6.2.3 Chlorine consumption

The consumption of chlorine by chloromethane mainly depends on the following consumption norms.

0.91 T/T Methylene Chloride

1.30 T/T Chloroform

1.51 T/T Carbon Tetrachloride

These consumption norms represent the total chlorine required including those for intermediate products. The consumption of chlorine by the chloromethanes sector was 65,950 T during 1996-97, with carbon tetrachloride accounting for 48%. The chlorine consumption by various chloromethanes, viz.  $\text{CH}_2\text{Cl}_2$ ,  $\text{CHCl}_3$  and  $\text{CCl}_4$ , in 1996-97 is 14,100 T, 20,150 T and 31,700 T respectively.

Assuming that the consumption of chlorine in chloromethane product during 2001-02 is 96,710 T, the estimated chlorine consumption is 1,79,346 T in 2010.

## 6.3 Identified Units for field studies

The units initially identified for detailed in-depth studies informed that the chloro-organic plants are shut down due to economy of operation since August 1999 and they may not run them in future also. Therefore, another unit was studied for chloromethanes production, chlorine utilisation and its mass balance.

Based on the questionnaire survey and through site visit to industry as well as discussion, the mass balance of chlorine utilisation has been studied. The brief process description, schematic flowsheet and model calculation of chlorine and its mass balance in chloromethane plant are detailed in **Annexure 6.1**.

### 6.3.1 Mass Balance of Chlorine Utilization in a Chloromethane Plant

The information provided by the unit on chlorine consumption, chloromethane and HCl production for the year 2000-2001, the mass balance of chlorine utilisation, and estimated major sources of chlorine losses is presented in **Table 6.1** through **Table 6.3** respectively. The stoichiometric mass balance of chlorine utilisation is depicted in **Fig. 6.1**. The total quantity of chlorine loss from various sources is 1249.274 MT during 1999-00 and 1309.305 MT during 2000-01.

**Table 6.1: Production of Chloromethanes and Chlorine Consumption**

| Description   | Production / Consumption (2000-01) (MT) |
|---|---|
| <u>Production</u>                                     |   |
| Mixed chloromethanes                                  |   |
| Methyl chloride (CH <sub>3</sub> Cl)                  | 33                                      |
| Methylene chloride (CH <sub>2</sub> Cl <sub>2</sub> ) | 9559                                    |
| Chloroform (CHCl <sub>3</sub> )                       | 9699                                    |
| Carbon tetrachloride (CCl <sub>4</sub> )              | 6650                                    |
| Total   | 25941                                   |
| HCl (30%)   | 77742                                   |
| <u>Chlorine Consumption</u>                           |   |
| Chlorine consumed                                     | 47401.273                               |

- Chlorine consumption norm: 1.830 MT/MT of product
- Actual Chlorine consumption norm: 1.829 MT/MT of product

**Table 6.2: Summary of Mass Balance of Chlorine Consumption in Chloromethanes**

| Sl. No. | Description   | Quantity 2000-01 (MT) |
|---------|---|-----------------------|
|         | <u>Chlorine Consumption</u>   |                       |
| 1       | Chloromethanes production   | 25941                 |
| 2       | HCl (30 %)  | 77742                 |
| 3       | Actual chlorine consumed  | 47401.273             |
|         | <u>Chlorine Balance</u>   |                       |
| 4       | Chlorine required as per norm for CLM   | 47446.09              |
| 5       | Difference between actual chlorine consumed and chlorine required as per norm for CLM | (-) 44.817            |
| 6       | Chlorine utilised for CLM   | 23045.984             |
| 7       | Chlorine utilised for HCl (100%) as byproduct with CLM                                | 23045.984             |
| 8       | Chlorine unutilised / unreacted (loss)  | 1354.122              |
| 9       | Total chlorine loss   | 1309.305              |

Table 6.3: Estimated Major Contributions of Chlorine Losses

| Sl. No. | Emission / Discharge Source   | Contribution from source 2000-01   | Chlorine equivalent losses 2000-2001 (MT) |
|---------|---|------------------------------------|---|
| 1       | Unreacted chlorine <ul style="list-style-type: none"> <li>• Thermal chlorination</li> <li>• HCl absorption</li> <li>• Compression &amp; deacidification</li> <li>• Purge gas treatment section</li> <li>• CLM distillation section</li> </ul> | 36 kg/MT CLM production            | 933.876                                   |
| 2       | Chlorine loss during start up and shutdown*   | 5.695 kg/ MT of CLM                | 147.74                                    |
| 3       | Chlorine loss through HCl scrubber  | 3.64 kg/MT of HCl (30%) production | 282.98                                    |

\* Chlorine from all the sections of CLM plant is neutralised and drained

Note: Unreacted chlorine of chlorination reaction is absorbed in caustic soda (12%) solution in counter-current scrubbing system and drained to effluent treatment plant

Fig. 6.1 : Stoichiometric Mass Balance of Chlorine Utilisation in Chloromethane Plant

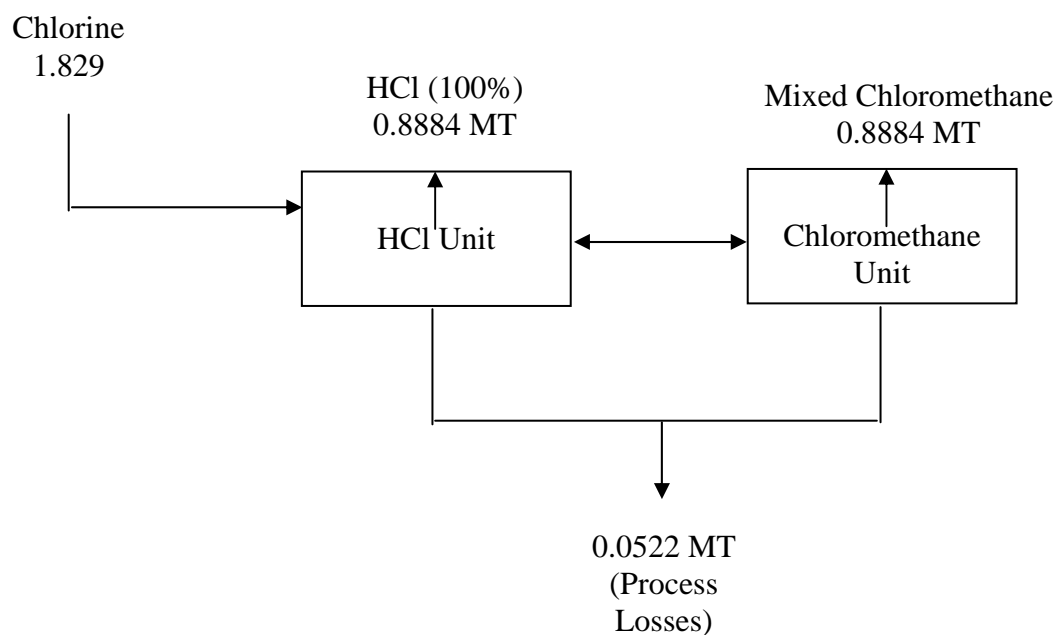

### 6.3.2 Emission Sources

The possible emission sources from chloromethane plant is as under:

- \* Unreacted chlorine
  - Thermal chlorination
  - HCl absorption
  - Compression & deacidification
  - Purge gas treatment section
- \* Chloromethane (CLM) distillation section
- \* Chlorine loss during start up and shutdown
- \* Chlorine loss through HCl scrubber

#### Chloromethane Losses in Effluent

About 190 m<sup>3</sup>/day wastewater is generated per tonne of chloromethane production and the sources are :

- Wash water from thermal chlorination
- Waste from hydrochlorination
- Bleed from methyl chloride quench tower and
- Spent dilute caustic liquor

The wastewater generated from these sources consists of hydrochloric acid (HCl) and chloro hydrocarbons. HCl is recovered from the wastewater.

### 6.3.3 Emissions and Control Measures

#### (i) HCl Emissions from HCl Unit

After thermal chlorination of methane gas, chloromethanes and HCl vapours are produced. HCl vapours are absorbed in demineralised (DM) water in graphite absorption column to produce HCl (30%). After recovery of HCl, tail gases are passed through water scrubber to absorb the traces of HCl.

Chlorine monitoring sensors are provided at liquid chlorine pump, thermal chlorination section, HCl synthesis unit, chloromethane distillation and storage section. The sensors detect chlorine as low as one part per million. Audio-visual alarm with continuous recording has been provided in the control room to take immediate corrective action. Prevailing wind direction is also continuously monitored and recorded in the control room.

#### (ii) Waste Air Dechlorination System

Chlorine bearing waste gases from various sections in the plant are processed in the waste air dechlorination unit. The gas is scrubbed with NaOH (18%) and unabsorbed gases are let its stage into the atmosphere. The scrubbing is carried out in two rubber lined towers in series for absorption of chlorine and bleach liquor (sodium hypochlorite solution) is kept in circulation through pump and a cooler to remove the heat generated due to above reaction. Both the absorption towers is in operation continuously and level of first tower is maintained by constant overflow to

second tower, whereas level of second tower is maintained by a level controller. The neutralised solution is drained into wastewater carrying system. The residual gases are vented into atmosphere.

All the equipment are connected to emergency power back up to take care of power failure and tripping.

The salient features of the waste chlorine absorption system are as under :

- Two staged packed columns are provided in series at waste air dechlorination system. Bulk of the chlorine absorption takes place in the first column itself and the balance in the second tower
- The system is designed to handle an emergency chlorine release corresponding to the full production of the plant for 10 minutes
- The composition of the scrubbing medium is continuously monitored and controlled by an on-line redox analyser with an alarm in the control room
- An adequate buffer stock of NaOH (18%) is maintained in a head tank and in the event of an emergency, the system is flooded with NaOH (18%) by the opening of an automatic on-off valve. A facility to manually open this valve is also provided
- Adequate temperature monitors and alarms are provided in the system
- The blowers and circulating pumps are connected to emergency power and are on auto-start ensuring that this unit is in operation all the time
- A chlorine detector is located at the exit point of the scrubber

#### 6.3.4 Handling of Emergency Leakages

The Central Control room is equipped with Distributed Control System (DCS) providing good number of process interlocks for plant, personnel and environmental safety. In case of emergency, the interlocks trip the plant to safe positions.

In the event of emergency, if gas pressure is very high, the rectifier trips and gas pressure is released to the waste air dechlorination unit. In the event of plant stoppage / start up or during operation chlorine is sucked through waste air blower and diverted to waste chlorine absorption system. The unabsorbed gases are vented to atmosphere. Caustic circulation pump and waste chlorine blowers are connected to automatic emergency back up power system.

#### Safety Measures

The safety measures that are incorporated as part of the process are :

- Mixing ratio of chlorine and methane is strictly maintained in order to prevent explosion
- During the emergency, the valves provided on critical lines get operated automatically to cut off chlorine, methane fuel to furnaces, steam to plant and methyl chloride filling to toner depending upon the type of emergency
- All other control valves are connected to control room to bring the plant to safe condition in case of power failure
- The compressors are designed to trip on abnormal process conditions like low suction pressure, high discharge pressure, failure lubrication system etc.

- Stoppage / tripping of any running equipment will indicate by an audio-visual alarm in the control room
- The storage tanks are provided with two safety valves, downstream of which connected back to the plant to avoid explosion hazard. The storage area is safe guarded with the help of gas leak detectors, explosion proof fittings and an elaborate water sprinkling system.

## 6.4 Chlorobenzenes

The production of chlorobenzenes depends on its end use products, viz. para-nitrochlorobenzene (PNCB), ortho-nitrochloro benzene (ONCB). The consumption of chlorine by chlorobenzene sector will be governed by end uses of chlorobenzene, viz. PNCB & ONCB.

PNCB is mainly used in production of:

- Paracetamol (50%), Dyes (30%) & others (pesticides, Rubber chemicals) (20%)

And, ONCB is limitedly used in:

- Dichlorobenzedine, orthoacacedine (dye intermediate)
- Orthophenylene diamine (pesticide intermediate).

Nitrobenzene is produced by nitration of chlorobenzene (CB) with nitrating mixture ( $\text{HNO}_3 + \text{H}_2\text{SO}_4$ ).

### 6.4.1 Production and Growth of Chlorobenzene

The PNCB & ONCB are produced in organised as well as SSI Sectors. The installed capacity of chlorobenzene is 65,000 T per annum and the production of PNCB & ONCB was 58,700 T during 1998-99. PNCB and ONCB are co-products manufactured in the ratio of 2:1.

The future production of chlorobenzene will be governed by growth / demand for PNCB. The production of PNCB + ONCB will grow at the rate of 7.3 % per Annum. The estimated production of PNCB + ONCB would be 1,27,457 T in 2010.

### 6.4.2 Chlorine Consumption for Chlorobenzene

The consumption of chlorine by chlorobenzene sector will depend on the consumption norms of PNCB + ONCB production. The chlorine required is 0.42 T per tonne of PNCB + ONCB. The consumption of chlorine was 24,662 T in 1998-99. The estimated chlorine consumption in 2009-10 would be 53,532 T.

In future, demand of PNCB + ONCB will be affected by demand of paracetamol, dye intermediate and other sectors which would grow by 7%, 15% and 7% respectively. This translates to 11.3% on a weightage basis.

### 6.4.3 Emission Sources

Emissions / Losses in manufacturing plant may occur from delivery system of chlorine or from the manufacturing process. The losses are in the form of solid, gaseous and liquid waste involved in process operation. Fugitive emissions occur from pump maintenance, relief valves and miscellaneous leaks at valves and other portions of the process equipment. Storage, handling & transportation losses occur



during loading operation of product into tank / tankers, tank trucks. Emission from loading operations is in small quantity.

Losses from storage vents, safety & relief valves, pump maintenance & vessel openings for inspection are included in fugitive emissions. In case of emissions, it is reported that the total amount of chlorine and its compounds emitted is around 0.2%.

The wastewater in nitrochlorobenzene (NCB) plant arises from two sections. The major part is contributed by the caustic and water washes in the purification process. The volume of wastewater is 3.35 m<sup>3</sup>/1000 kg product and is expected to contain NCB, DNCB and some chlorobenzene oxides, sodium sulphate, nitrate and nitrite. The other wastewater stream from scrubbing of nitrate fumes about 0.8 m<sup>3</sup>/1000 kg product may contain some volatile organics. Another possible source of wastewater in some plants may be the barometric condenser, which is used to maintain vacuum in distillation section. This may contain traces of organics. It is reported that the Quantity of chlorine / chloro-compound through wastewater is about 0.2 %.

## 6.5 Chloroethanes

The chloroethanes are divided into two main products, viz. Tri-chloroethylene and other Chloroethanes. Tri-chloroethylene is used as degreaser. The installed capacity of chloroethane is 20,400 T.

### 6.5.1 Production / Demand

The growth in production of chloroethane is mainly due to its use as degreaser and in refrigerants system. The production of chloroethane is 16,015 T in 1999-2000 and the estimated production in 2009-10 would be 32,100 T. In order to meet the projected production demand of chloroethane, creation of additional capacity would be required in addition to the present capacity of 20,400 T.

### 6.5.2 Chlorine Consumption for chloroethane

The consumption of chlorine by chloroethane sector mainly depends on the norm of chlorine consumption. 1.1 T chlorine is required to produce one tonne of chloroethane. The consumption of chlorine for production of chloroethane is 17,617 T in 1999-2000 and 35,307 T of chlorine would be required by the year 2009-10 for projected production of 32,100 T of chloroethane.

**Trichloroethylene** : In case of trichloroethylene effluent / wastewater mainly two sources of chlorine based wastewater. These sources are wastewater from barometric condenser with 1.5 - 2% HCl and other from vent gas scrubber. The total quantity of wastewater is 8.8 m<sup>3</sup>/T of product.

## 6.6 Propylene Oxides

Propylene oxide is prepared by chlorohydration reaction of propylene and chlorine. The propylene oxide is used to prepare propylene glycol and polyols.

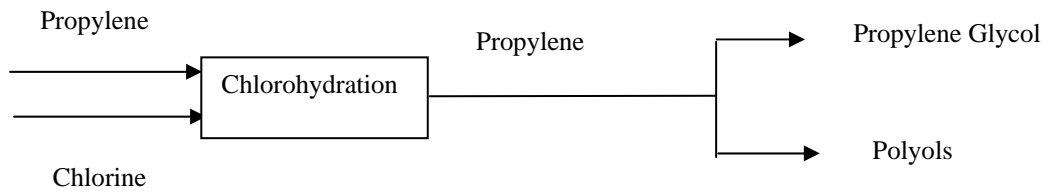

In India, there is only one producer of propylene oxide with an installed capacity of 24,000 TPA. The production of propylene oxide in the country was 21,560 T in 1997-98.

The two major factors inhibit any new capacities for propylene oxide / propylene glycol / polyols :

- Lack of availability of merchant propylene
- Imports: Lower international costs / prices due to large capacity plants abroad

### Chlorine consumption

Chlorine is consumed in chlorohydration of propylene to produce propylene oxide. One tonne of propylene oxide will consume 1.45 T of chlorine. The consumption of chlorine to produce 21,000 T of propylene oxide in 1996-97 was 30,450 T.

The emissions in propylene oxide plant occur from fugitive sources and manufacturing process, and it is reported that about 2% of chlorine consumption emissions occur.

### 6.7 Epichlorohydrin (ECH)

Epichlorohydrin is prepared by the reaction of propylene with chlorine using Allyl chloride as catalyst. The reaction for epichlorohydrin is as under :

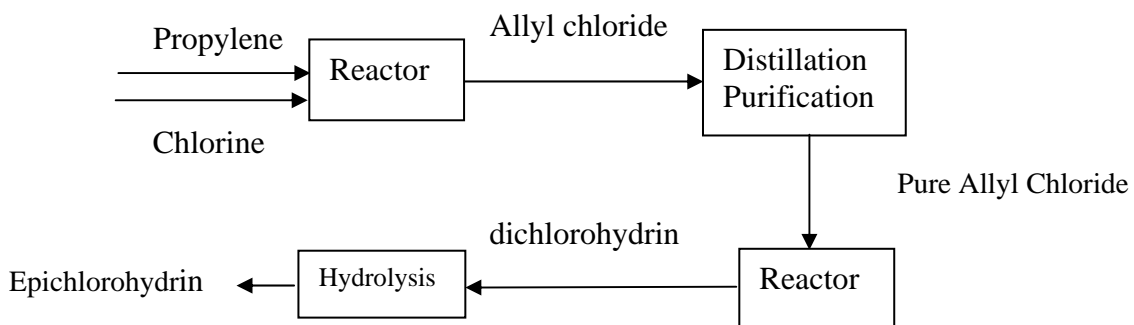

There is only one plant making ECH with an installed capacity of 11,000 T and its production is mainly exported. The production of ECH was 6,888 T in 1998-99 and 8,029 T in 1999-2000.

### Chlorine Consumption

Chlorine is consumed by propylene to produce epichlorohydrin. The chlorine consumption will depend on the consumption norms.

Consumption norm: 2.2 T of chlorine per ton of product.

The chlorine consumption in 1998-99 for production of 6,888 T ECH was 15,153 T and in 2010 chlorine consumption would be 24,200 T assuming 100% capacity utilisation. At present there are no plans to set up additional plant. The chlorine consumption of 24,200 T represents a growth of CARG 17% over 1998-99.

## 6.8 Monochloro Acetic Acid (MCA)

Monochloro Acetic Acid (ClCH<sub>2</sub>COOH), also known as chloroacetic acid or chloroethanoic acid, is made up of white hygroscopic crystals. Chlorinated acetic acids have become important intermediates in organic synthesis because of the easy substitution of the chlorine atoms that does not occur in nature.

The production of MCA (1998-99) is around 20,000 TPA registering a growth of 10% annually. MCA is being manufactured in India both in the organised as well as in small scale sector. While, there are six units in the organised sector, around 15 to 20 units in the SSI sector; mainly located in Gujarat, Maharashtra and Andhra Pradesh. The total installed capacity is 24,000 TPA. MCA production is accounted by several manufacturers with inhouse / merchant production. Two grades of MCA are produced, viz. MCA-85% and MCA-98%.

### 6.8.1 Manufacturing Process

The various methods have been proposed and patented for production of MCA. However, of all the methods described, only two are used on an industrial scale: (1) the hydrolysis of 1,1,2-trichloroethylene catalyzed with sulphuric acid, and (2) the catalyzed chlorination of acetic acid with chlorine.

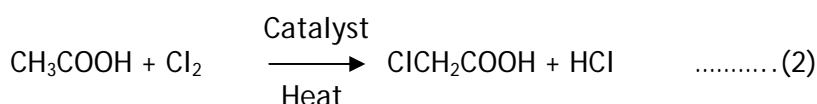
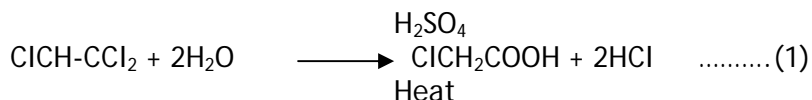

The first method has become technologically significant; the second is obsolete historically and commercially. Currently, first method is the most important process.

### 6.8.2 Production and Demand of MCA

The production of MCA is about 75% against the installed capacity of 24,000 T. The production of MCA during 1998-99 was 19,800 T. The estimated production of MCA is 56,472 T in 2009-10. Keeping in view the growth of the end use sectors, the demand for MCA is expected to grow at the rate of 10% per annum over 1998-99.

### 6.8.3 Chlorine Consumption for MCA

The consumption of chlorine by MCA depends on production of two MCA grades. The norms for consumption of chlorine for 85% grade MCA is 0.80 T of chlorine per tonne of product and for 98% grade MCA, 1.10 T of chlorine per tonne of product is required.

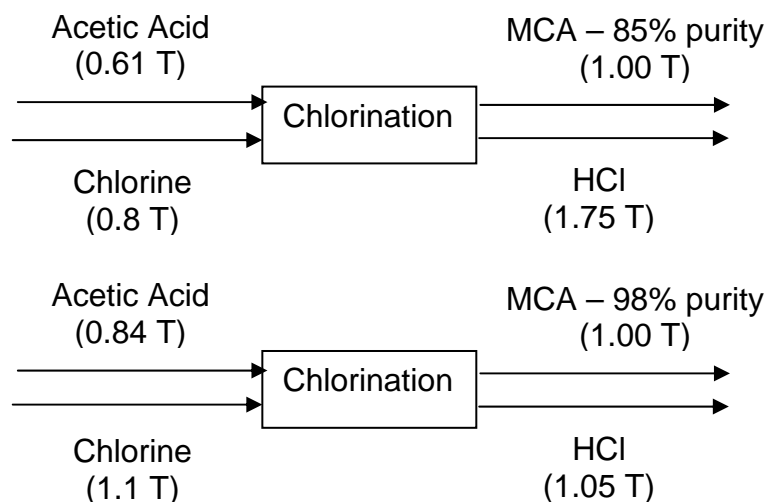

From the above, it is found that the production of 98% grade is roughly a quarter of the total MCA production. The future consumption of MCA is based on end use of 85% and 98% MCA growth. The estimated chlorine consumption will be 49,413 T in 2010.

### 6.9 Other Organic Chemicals

The other chlorinated organics are chlorinated acetone, chloroacrolein (tear gas), chlorotoluenes, etc. It is estimated that the consumption of chlorine for other organic compounds in 1998-99 was 11,081 T and would be 25,836 T in 2009-10.

The chlorine consumption for various organic segments / organic industrial sectors would be 3,66,239 T in 2009-10 (including chlorine consumption by pesticide sector).

## 7.0 Pesticides Industry Sector

### 7.1 General Status

India is one of the most dynamic generic pesticide Industry in the world having total installed capacity of technical grade pesticides approximately 1,30,000 MT with 55 basic producers of technical grade pesticides. It consists of large and medium scale (including 10 multinational companies) and 300 pesticide formulators (large, medium and small scale), spread all over the country. The total market size is around Rs. 4100 crores. The pesticides industry in India continues to make accelerated progress and today 93 technical grade pesticides are being manufactured in the country. More than 125 units are currently engaged in the manufacture of these technical grades pesticides and over 300 units are making pesticide formulations.

Use of pesticides in India was made for the first time on a small scale by importing DDT for malaria control and BHC for locust control in 1948. Pesticides use in Agriculture began for the first time in India in 1949. Indian production of pesticide began with establishment of DDT & BHC plant in 1954. By 1958, India was manufacturing 5 basic pesticides with a production of over 5000 MT. Thereafter, Industry has a study progress reaching a production volume of about 60,000 MT per annum in mid eighties and 96,500 MT in mid nineties. The use of some pesticides has been banned or restricted in this country. The list of banned and restricted pesticides, which includes most of the chloro-pesticides is presented in Table 7.1.

Table 7.1: List of Pesticides / Pesticides formulations banned in India

| A. Pesticides Banned for manufacture, import and use (25 Nos.) |                            |
|--|----------------------------|
| 1.   | Aldrin                     |
| 2.   | Benzene Hexachloride       |
| 3.   | Calcium Cyanide            |
| 4.   | Chlordane                  |
| 5.   | Copper Acetoarsenite       |
| 6.   | Clbromochloropropane       |
| 7.   | Endrin                     |
| 8.   | Ethyl Mercury Chloride     |
| 9.   | Ethyl Parathion            |
| 10.  | Heptachlor                 |
| 11.  | Menazone                   |
| 12.  | Nitrofen                   |
| 13.  | Paraquat Dimethyl Sulphate |
| 14.  | Pentachloro Nitrobenzene   |
| 15.  | Pentachlorophenol          |
| 16.  | Phenyl Mercury Acetate     |
| 17.  | Sodium Methane Arsonate    |
| 18.  | Tetradifon                 |
| 19.  | Toxafen                    |

|  |   |
|--|---|
| 20.  | Aldicarb                                  |
| 21.  | Chlorobenzilate                           |
| 22.  | Dieldrine                                 |
| 23.  | Maleic Hydrazide                          |
| 24.  | Ethylene Dibromide                        |
| 25.  | TCA (Trichloro acetic acid)               |
| <b>B. Pesticide / Pesticide formulations banned for use but their manufacture is allowed for export (2 Nos.)</b> |   |
| 26.  | Nicotin Sulfate                           |
| 27.  | Captafol 80% Powder                       |
| <b>C. Pesticide formulations banned for import, manufacture and use (4 Nos)</b>                                  |   |
| 1.   | Methomyl 24% L                            |
| 2.   | Methomyl 12.5% L                          |
| 3.   | Phosphamidon 85% SL                       |
| 4.   | Carbofuron 50% SP                         |
| <b>D. Pesticide Withdrawn(7 Nos)</b>   |   |
| 1.   | Dalapon                                   |
| 2.   | Ferbam                                    |
| 3.   | Formothion                                |
| 4.   | Nickel Chloride                           |
| 5.   | Paradichlorobenzene (PDCB)                |
| 6.   | Simazine                                  |
| 7.   | Warfarin                                  |
| <b>Pesticides Restricted for Use in India</b>  |   |
| <b>S.No.</b>   | <b>Name of Pesticides</b>                 |
| 1.   | Aluminium Phosphide                       |
| 2.   | DDT                                       |
| 3.   | Lindane                                   |
| 4.   | Methyl Bromide                            |
| 5.   | Methyl Parathion                          |
| 6.   | Sodium Cyanide                            |
| 7.   | Methoxy Ethyl Mercuric Chloride (MEMC)    |
| 8.   | Monocrotophos(ban for use on vegetables)  |
| 9.   | Endosulfan(Banned in the state of Kerala) |
| 10.  | Fenitrothion                              |

In manufacture of pesticides, chlorine or / and its compounds are used in large quantities. These pesticides are used as Fungicides, Insecticides, Herbicides, Rodenticide, Nematocide etc. They are first manufactured as technical grade products having least chemical purity consumable pesticides are then produced by conversion of

these products into approved formulations which are tailor made for application on diverse insect-pest spectra, plant diseases, weeds etc.

## 7.2 Technological status

The manufacturing process differs from pesticide to pesticide. At present 93 technical grade pesticides being manufactured in the country. The pesticides industry followed under two distinct categories, viz. manufacturing of pesticides and formulation and exclusive formulation

Technology of pesticides manufacture is available from foreign countries and technology provided by Indian institutions such as NCL, Pune; IICT, Hyderabad; IITs etc. and Indian companies. Indian companies have developed process technologies for more than 30 pesticide active ingredients.

The chloro-pesticides like Endosulfan, Fenvalerate, Cypermethrin, Alphamethrin, Deltamethrin, Chlorpyrifos, Malathion and Monocrotophos are manufactured by many Indian companies and India is one of the largest producers of these pesticides in the world. Pesticides, based on their use on the target organism may be classified as insecticides, fungicides, rodenticides, nematicides, herbicides and plant growth regulants.

## 7.3 Production, Consumption and Demand of Pesticides

The production of pesticides during 1998-99 was 89,000 MT at 69% capacity utilisation from an installed capacity of 1,30,000 MT. This improved to 94,500 MT (1999-00) along with capacity use at 73%, in the next year while in 2000-01 the output rose further to 1,03,000 MT with capacity utilisation of around 80%. Domestic players account for 60 per cent of capacity / production and MNCs for the balance.

The domestic Agro-chemical Industry is expected to sustain its high growth - the key demand driven for Agro-chemicals being the growing population (1.8% growth rate). The production of technical grade pesticides is as under:

| Sl. No.      | Pesticides   | 1996-97 (MT)  | 1997-98 (MT)  | 1998-99 (MT)  |
|--------------|--------------|---------------|---------------|---------------|
| 1.           | Insecticides | 38,111        | 41,307        | 42,198        |
| 2.           | Fungicides   | 20,795        | 26,098        | 27,152        |
| 3.           | Hertricides  | 10,651        | 12,919        | 13,960        |
| 4.           | Rodenticides | 1,550         | 1,345         | 1,400         |
| 5.           | Fumigants    | 1,222         | 1,523         | 1,675         |
| <b>Total</b> |              | <b>72,329</b> | <b>83,192</b> | <b>86,385</b> |

Source :Pesticides information, Jan - March 1999

The demand for herbicides, fungicides and insecticides growing at the rate of 12%, 17% and 10% respectively as compared to 10% growth in the demand of Technical grade pesticides.

## Consumption of Pesticides

Pesticide consumption in India is low, less than 800 g/acre against 16 kg/acre in the US. The leading Agro-chemicals (chloro-pesticides) consumed in India are Monocrotophos, Cypermethrin, Endosulphan, Quinalphos, Chlorpyriphos, Fenvalerate, Acephate, Phorate, Phosphamidon. The top selling insecticides account for around 95% of total chemical market in volume terms, Monocrotophos is the largest selling Agro-chemical in India.

### (i) By Class wise

There is a marked difference in the consumption pattern of agro-chemicals in India vis-a-vis the rest of the world. The Insecticides accounts for 76% of the total consumption of pesticides, herbicides 10%, fungicides 13% and Rodenticides 1%. The average World Consumption Comprises 44% Insecticides, 30% herbicides, 21% fungicides and 5% Fumigants.

### (ii) By chemical class

In terms of chemical class, organochlorine compounds account 16%, 50% organo phosphorous, 4% carbamates, 19% synthetic pyrethroids, 1% biopesticides and 10% others. The average world consumption pattern is 6% organochlorides, 37% organophosphates, 23% carbamates, 22% synthetic pyrethroids and 12% Biopesticides.

## 7.4 Chlorine Consumption in Pesticides

In India, about 6% of chlorine production is used for pesticides production, from this about half gets converted in to hydrochloric acid. BHC, Lindane, Endosulfan, Chloropyriphos, Monocrotophos, Acephate etc. are consuming large amount of chlorine. The quantity of chlorine consumed by various pesticides depends on the consumption norms, as the number of chloro-pesticides is large and technology differs from pesticide to pesticide.

The quantity of chlorine consumption depends on various factors :

- Existing manufacturer capacity of chloro-pesticides
- Existing demand and consumption pattern of pesticides
- Market demand and growth pattern of organochlorines
- Product banned for production
- Agriculture sector

The chlorine consumption in pesticides Industry during 1996-97; 1997-98 and 1998-99 was 32,500 T, 28,600 T and 25,168 T respectively. This showed that the chlorine consumption in this industry was decreasing year after year. This is taking into account of the nil consumption of BHC since, it was banned from April 1, 1997 and existing manufacturers have stopped production of BHC. In 1995-96, about 22,000 tonnes of BHC was used in India. The organochlorine pesticides mostly consumed are Monocrotophos, Endosulphan, Chloropyriphos, Acephates etc. In future, the chlorine consumption in pesticides industry would further come down, because the growth in chlorinated pesticides is expected to decrease continuously.



As per the questionnaire information provided by the identified unit, the chlorine consumption for production of monocrotophos and chloropyriphos was 661 MT during 1996-97; 538 MT in 1997-98 and 484 MT in 1998-99.

Two major pesticides BHC and DDT account for approximately 50% of total installed capacity of all pesticides manufacture. These pesticides involved large consumption of chlorine and these are now banned.

The chlorine consumption in the country in future would be influenced by the following:

- BHC banned for production
- Lindane is the gamma-isomer of BHC, so lindane is a substitute for BHC. Hence, banned on BHC sales will have a favourable impact on lindane. This is likely to be transferable to 10% growth in next few years
- Growth of other pesticides which is expected to grow 8% in next 5 years
- Research & Development facility
- Long term demand projection

Long term projections for pesticides as well as chlorine consumption by chloro-pesticides is difficult due to the following :

- Change in cropping pattern such as increase or decrease in crops like sugarcane & cotton, where large amount of pesticides is being used
- Increasing emphasis on production of oil seeds & pulses
- Increase in land cover use under high yielding varieties
- Enhanced awareness for plant production especially, the cost benefit ratio of pesticides
- Encouragement for Agricultural practices
- Intensive extension work undertaken jointly by the Industry & the Department of Agriculture including safe and judicious use of pesticides
- Export/Import policy.

## 7.5 Export / Import

The quantity of chlorine requirement also depends on the export and import of chloro-pesticides . Pesticides exports from India are on the rise and have observed a growth of 10% to 15% in the last three years and is expected to grow faster in coming years. The major exported chloropesticides are Captan, Catafol, Endosulphan, Fenvalerate, 2-4D, Lindane, cypermethrin Quinalphos, etc. The export performance of pesticides industry is presented as under:

| Year      | (Rs. In Crores) |
|-----------|-----------------|
| 1996 - 97 | 710.43          |
| 1997 - 98 | 678.8           |
| 1998 - 99 | 945.0           |

Source: Pesticides information Jan - Mar 1999  
& Chemical Industry News, January 2000.

The major Agro-chemicals imported to India are Chloropyriphos, Heptachlor, Chloridane, Dicofol, Thiram, Butachlor, Altrazin, Pacolbutrazol and Oxyfluofen etc. As a result of the increased production of pesticides in the country, import of technical grade pesticides has declined considerably.

## 7.6 Pesticides and Persistent Organic Pollutants (POPs)

Toxic chemicals, which persist for long periods in the environment without breaking down, are among the most dangerous pollutants resulting from human activities. Most POPs such as dichlorodiphenyl trichloroethane (DDT), aldrin and toxaphene are manufactured for use as pesticides, while others such as polychlorinated biphenyl (PCB) and hexachlorobenzene (HCB) are industrial chemicals. Others such as dioxins and furans are by-products produced during waste disposal processes such as incineration. They circulate freely and globally, transporting themselves through the atmosphere and water to regions far away from their original source.

Countries have now come together to negotiate a new global treaty, which will aim to control and eventually remove them from the environment.

In many developing countries, where POPs have wide varieties of agricultural uses and are also traded internationally, the elimination of persistent pesticides is an economic concern. There are 12 POPs known as dirty dozen, which contribute to persistent global pollution. 'The Dirty Dozen POPs' identified for priority action under the Stockholm Convention are either organochlorine compounds or related to organochlorine compounds (eight organochlorine pesticides, Hexachlorobenzene, Polychlorinated biphenyls (PCBs), Dioxins and Furans).

### POPs and Developing Countries

The modern history of POPs began in 1945 with the large-scale manufacture of DDT as an insecticide to eradicate disease carrying insects from fields, and to control mosquitoes. Many developing countries have little or no data on the use or release of POPs. They lack inventories of stockpiles of obsolete pesticides and industrial chemicals.

### POPs and India

India's relationship with pesticides started during the Green Revolution in the 1960s, when it intensified its agricultural production using high yielding varieties of seeds, combined with fertilisers and pesticides. Indigenous pesticides production began in 1954 with DDT. Since then, pesticide use has been increasing at the rate of 12 per cent a year over the past two decades.

Information on 'The Dirty Dozen POPs' and six additional chemical compounds, which also include four organochlorine compounds, is presented in **Annexure 7.1**. The government has introduced a few controls on pesticide use in the past. Of these 18 priority POPs, 7 organochlorine pesticides (i.e Aldrin, Chlordane, Endrin, HeptachlorToxafen, Pentachlorophenol and Dieldrin) have been banned for manufacture, import and use and use of 2 other organochlorine pesticides (DDT and Lindane) has been restricted in India. The Ministry of Chemicals and Fertilisers' data on pesticides, which are produced in, or imported into the country, does not feature Hexachlorobenzene (HCB) and Mirex.

### Viable Solutions

Alternatives to DDT such as synthetic pyrethroids are available, they are yet to become popular. These substances break down more quickly and do not linger in the environment, but are more acutely toxic, and therefore, require proper handling and application. An effective, and cheaper, alternative to DDT is bioenvironmental

management. The essence of the bioenvironmental method is the easiest way to check malaria - prevent mosquitoes from breeding. This alternative method to chemicals was pioneered by two premier institutions in India - the Malaria Research Centre (MRC), New Delhi and the Vector Control Research Centre (VCRC), Pondicherry - when resistance to chemicals rose dramatically in the early 1980s in the country. Bioenvironmental management involves:

- Biological management, which includes releasing larvae-eating fish in open waterbodies, and spraying biological - rather than chemical - larvicides
- Environmental management, which includes improving drainage and sanitation systems, filling up of ditches, use of treated mosquito nets, and covering domestic water tanks.

Besides being effective, these programmes are also very cost effective. As per the MRC the bioenvironmental management method is the cheapest way of preventing malaria, cheaper than DDT.

### 7.7 Alternatives to POPs

Key conclusions of the study are :

- A wide range of alternatives currently exist for all intentionally produced POPs, but the suitability of specific alternatives needs to be evaluated in the context of national or regional capabilities and circumstances
- Chemicals as well as the non-chemical alternatives to DDT exist. Non-chemical methods for controlling malaria include environmental management such as the elimination of larval breeding sites, improved housing conditions including screening with mosquito netting, while chemical alternatives include use of synthetic pyrethroids, malathion, bendiocard and other pesticides
- For chlordane and heptachlor, effective alternative pesticides such as chlorpyrifos are available. Some of these alternatives may however require more frequent treatment, making them costlier
- In case of alternatives for polychlorinated biphenyls (PCBs), the main option is to avoid chemical substitutes, and instead introduce alternative engineering designs for its main sources like industrial transformers and capacitors
- Waste incineration is the main source of dioxins and furans emissions though the introduction of improved technologies can reduce the emissions considerably.

### 7.8 Alternatives to Pesticides

Alternatives available in place of chloro-pesticides are :

- Biopesticides
- Chiral compounds
- Better formulation and mode of delivery and
- Organic farming

**Bio-pesticides** : At present, there are some companies in the small, medium and large scale sector manufacturing or marketing bio-pesticides. However, most of these companies have not made any study on the efficacy and shelf life of their products in actual field applications.

**Organic Farming** : In Kottayam and Eranakulam districts of Kerala, the farmers have started practicing organic farming in paddy fields. The farmers have discovered that, in some of the paddy cultivation fields, the yield is 2,500-2,600 kg/ha with the use of organic farming while it is only 1,000-1,100 kg/ha with chemical fertilisers and pesticides.

The cost of inputs in organic farming is about Rs.3,000 per hectare while it is Rs. 8,500-9,000 with chemical fertilisers and pesticides. The farmers have discovered that cultivation of cowpea and vegetables after harvesting paddy and using compost manure three times in a year makes the soil fertile. The farmers use about 350 kg compost after 30 to 45 days of sowing. The farmers use a bio-pesticides made from crushed garlic, chillies and asafoetida which is sprayed in paddy fields after short intervals. In rubber and tea plantations, farmers have started using compost and neem extract and are obtaining better yields than using chemical fertilisers and pesticides.

The other alternatives are:

- Integrated pest management considerably reduces use of pesticides and promotes use of appropriate pesticides at right time and proper application method further reduce the adverse impact on environment
- Education of farmers on proper use and waiting period before harvesting and consumer awareness programme will go a long way in reducing damage and toxic effect.

## 8.0 Inorganic Chemicals Sector

### 8.1 General Status

Chlorine or its compounds are used directly or indirectly for manufacture of various inorganic compounds, which are used as raw materials for other industries, viz. dyes, pharmaceuticals, drugs etc. The major inorganic chemicals involving chlorine are :

- Stable Bleaching Powder
- Chloro sulphonic acid
- Calcium Hypochlorite
- Sodium Hypochlorite
- Hydrochloric acid
- Other chemicals
  - Aluminium chloride
  - Ammonium chloride
  - Ferric chloride

### 8.2 Chlorine Consumption

The inorganic chemical industries account for about 9% of the total chlorine consumption in the country. In addition about 30% is consumed in the production of HCl. The chlorine consumption for total inorganic chemicals excluding hydrochloric acid in 1999-00 was 1,30,329 T. The projected chlorine consumption for major inorganic chemicals excluding hydrochloric acid is likely to be 2,81,651 T in 2009-10 with growth rate of CAGR 8%. The estimated Chlorine consumption for major inorganic chemicals excluding hydrochloric acid is presented in Table 8.1.

Table 8.1: Estimated Chlorine Consumption for Major Inorganic Chemicals (Tonnes)

| Description             | Estimated chlorine consumption in 2009-10 |
|-------------------------|---|
| Stable Bleaching Powder | 82,826                                    |
| Chloro Sulphonic Acid   | 1,51,302                                  |
| Calcium Hypochlorite    | 16,868                                    |
| Sodium Hypchlorite      | 19,278                                    |
| Hydrochloric Acid       | 7,80,620                                  |
| Others                  | 11,377                                    |
| <b>Total</b>            | <b>2,81,651</b>                           |

The brief manufacturing process of inorganic chemicals, their production and consumption of chlorine are detailed here under:

### 8.3 Stable Bleaching Powder

The stable bleaching powder (SBP) is widely used as disinfectant, bleaching agent in laundry, etc. It is a mixture of calcium hypochlorite  $\text{CaOCl}_2$  and  $\text{Ca}(\text{OCl})_2$ . Maintaining appropriate process conditions during manufacture improves the stability of bleaching powder.

### 8.3.1 Manufacturing process

For the manufacture of good quality bleaching powder the lime must be carefully slaked so as to form a dry powder, containing about 4% moisture and slaked lime  $[\text{Ca}(\text{OH})_2]$ ; dry lime does not absorb chlorine. The lime should be as pure as possible. Chlorine gas should be cool and dry and carefully freed from HCl and should not contain much  $\text{CO}_2$ . Slaked lime, 64 parts yield 100 parts of 36% bleaching powder. If the temperature of lime is kept between 30 and  $40^\circ\text{C}$ , bleaching powder containing 40% of available chlorine may be obtained. Under very special circumstances lime has been known to take up as much as 43.5% of available chlorine. The actual amount of available chlorine depends greatly on the mode of manufacture.

### 8.3.2 Production and Demand of SBP

Stable bleaching powder is manufactured in large as well as small-scale sectors. During 2001-02 the total production of SBP was 1,09,500 T. The projected demand for SBP would be 1,88,240 T in 2009-10 with anticipated growth rate (CAGR) of 7%. The production is expected to exceed the installed capacity marginally, which will be made up by the existing manufacturers through increase in the installed capacity.

### 8.3.3 Chlorine Consumption

The consumption of chlorine by SBP segment in inorganic sector depends on the consumption norms. Chlorine requirement per ton of SBP produced is 0.44 T. The chlorine consumption during 2001-02 was 48,200 T. The projected chlorine consumption would be around 82,826 T in 2009-10.

## 8.4 Chloro Sulphonic Acid

Chloro sulphonic acid (CSA) is used in the preparation of Vinyl Sulfone, as Drug intermediate, in saccharine preparation, detergents, dyes and pigments, pesticides and ion-exchangers.

### 8.4.1 Manufacturing Process

Most commercial plants for manufacturing chloro sulphonic acid employ the direct union of sulphur trioxide with dry HCl gas. The  $\text{SO}_3$  may be in the form of liquid or gas as obtained from oleum (fuming sulphuric acid) or may be present as a dilute gaseous mixture obtained directly from a contact sulphuric acid plant. The reaction is exothermic and takes place spontaneously.

### 8.4.2 Production and Demand of CSA

The total production of CSA in 1999-00 was 1,22,500 T against the total installed capacity of 2,14,500 T. The estimated production with average growth rate (CAGR) of 9.06% will be around 4,58,490 T in 2009-10. The demand growth for CSA is highly variable in end use segments. It is estimated that roughly one fifth of the production is accounted by chloro-alkali manufacturers.

### 8.4.3 Chlorine Consumption

The chlorine consumption depends on the consumption norms. For production of one tonne of CSA, 0.33 T of chlorine is required. The chlorine consumption was 40,425 T in 1999-00 and the increase in demand would be 1,51,302 T in 2009-10.

## 8.5 Calcium Hypochlorite

### 8.5.1 Manufacturing Process

Calcium hypochlorite  $\text{Ca}(\text{ClO})_2$  is manufactured by slowly passing chlorine gas into a cold aqueous milk of lime, filtering the liquid and evaporating the alkaline liquid in vacuum, when colourless crystals of  $\text{Ca}(\text{ClO})_2$  separate. These are washed and dried in vacuum when a dry white powder free from moisture and water of crystallization is obtained in which no less than 80-90% of the chlorine present is in the form of available chlorine. The crystals, if not rapidly deprived of water, lose much chlorine.

If the chlorination be carried out with a concentrated solution of slaked lime, so that the specific gravity of the filtered solution exceeds 1.15, then double compounds of lime precipitate and calcium hypochlorite of composition is  $\text{Ca}(\text{OCl})_2 \cdot 2 \text{Ca}(\text{OH})_2$  and  $\text{Ca}(\text{OCl})_2 \cdot 4 \text{Ca}(\text{OH})_2$ . These insoluble substances require a considerable volume of water to split them up and retard effective use a considerable amount of available chlorine, causing much of milkiness in the solution of bleaching powder. However, if the passage of chlorine into the liquid is continued these compounds are gradually attacked, the  $\text{Ca}(\text{OH})_2$  takes up chlorine and get converted to  $\text{Ca}(\text{ClO})_2$ . Hence, in order to prepare very strong solutions, it is necessary to add to the chlorinated slaked lime solution a weighed quantity of slaked lime, when a precipitate occurs of the above compounds; then chlorine gas is passed until the precipitates are dissolved again by the complete chlorination of the lime. By repeating the addition of lime and passing chlorine again, it is possible to obtain calcium hypochlorite solutions of almost any strength until the pure  $\text{Ca}(\text{OCl})_2$  crystals begin to separate.

### 8.5.2 Production and Demand of Calcium Hypochlorite

During 1999-00 total production of  $\text{Ca}(\text{OCl})_2$  was 1,22,500 T. By 2009-10 the production is expected to be about 2,40,900 T. Chloro-alkali manufacturers generally produce 50% calcium hypochlorite.

### 8.5.3 Chlorine Consumption

The chlorine consumption depends on norms formulated. The consumption norm is 0.07 T/T of  $\text{Ca}(\text{OCl})_2$ . Chlorine consumption was 8,575 T in 1999-2000. It is estimated that by 2009-10 chlorine consumption would be 16,860 T.

## 8.6 Sodium Hypochlorite

It is used in the formulation of detergents, for purification of swimming pool and municipal water supplies, sanitation and textile & laundry bleaching. Hypochlorites can be used as disinfectants, a solution containing 10% available chlorine is 25 times as effective as phenol.

### 8.6.1 Manufacturing Process

By passing chlorine gas into the strongest possible solution of NaOH, needle shaped crystals of formula  $\text{NaClO} \cdot 6\text{H}_2\text{O}$  are obtained. In order to obtain a highly concentrated solution of hypochlorite, the temperature must not exceed  $27^\circ\text{C}$  and alkali must be present in excess, and must be so concentrated that any NaCl formed is precipitated (NaCl is insoluble in conc. NaOH).

### 8.6.2 Production and Demand of Sodium Hypochlorite

The production of sodium Hypochlorite during 1999-00 was 1,22,500 T of which 50% is accounted by chlor-alkali manufacturers. The estimated production with a growth rate (CAGR) of 7% would be 2,40,975 T in 2009-10.

### 8.6.3 Chlorine Consumption

Chlorine consumption depends on the consumption norms. Consumption norm is 0.08 T/T of NaOCl produced. Chlorine consumption was 9800 T during 1999-00. Estimated increase in chlorine consumption would be 19,280 T in 2009-10.

## 8.7 Hydrochloric Acid (HCl)

### 8.7.1 Production and Demand of HCl

HCl production during 1996-97 was 14.1 lakh tonnes. Of this DM water plants and pickling accounted for nearly 48% of the overall production. The demand will grow to 35.64 lakh tonnes in 2009-10.

### 8.7.2 Chlorine Consumption

The quantity of chlorine used for HCl is based on end use segments. The chlorine consumption in 1996-97 for production of 14.1 lakh tonnes HCl was 3,48,500 T; 3,70,804 T in 1997-98. It is estimated that the total chlorine demand, would be 7,80,620 T in 2009-10 at the growth rate (CAGR) of 6.4% over 1996-97.

## 8.8 Other Inorganic Chemicals

The other inorganic chemicals include ammonium chloride, aluminum chloride, ferric chloride, etc. The consumption of chlorine by "other inorganics" is only 1% of total chlorine as compared to other segments. It is estimated that chlorine consumption for other inorganic chemicals will increase from 5,006 T in 1996-97 to around 11,377 T by 2010.



## 9.0 Water and Wastewater Treatment Sector

### 9.1 Water Treatment

Chlorine is used in 98% of the water treatment plants in the world. Currently, water treatment accounts for 6% of chlorine production. In India, chlorine is used for disinfection of drinking water. There are usually two disinfection steps in the treatment of potable water. In the pre-oxidation stage, disinfectant is added to water to destroy offensive constituents and prevent algal and other growths in the plant. Post disinfection is done at the end of the purification process is the most important disinfection step in terms of protecting human health. It is usually the intention to leave a residue of active agent, chlorine, to prevent any contamination in the water distribution network.

The consumption of chlorine for drinking water supply systems in urban and rural areas is in the form of chlorine gas, liquid chlorine and bleaching powder. Most of the organised water supply systems in urban and semi urban areas, chlorine is used as a disinfectant, while in rural sector where pump and supply system is in practice, bleaching powder is used for disinfection in rural water supply.

The consumption of chlorine in water treatment depends on the dosing pattern and form of chlorine used. In 1996-97, the consumption of chlorine in this sector was around 59,431 MT and 63,880 MT in 1997-98.

The urban and semi urban areas are covered by organised water supply schemes where chlorine is used regularly for disinfection in water treatment, only these areas are considered for the purpose of calculating chlorine consumption in water treatment.

Water supply through ground and surface water sources in these metro cities is 12,740 mld, in class I cities is 20,923 mld and in class II cities is 2031 mld (1991).

The data collected from questionnaires and discussion with water supply authorities, revealed that 2 mg/L chlorine dose which is adequate for treated water to maintain the residual chlorine of 0.2 mg/L at the consumer end, is known to be utilised for disinfection.

The chlorine consumption is computed for water treatment on the basis of water supply provided in metro cities, class I cities and class II cities. At the rate of 2 mg/L chlorine dose, the amount of chlorine is required at 2 kg per million liters of water at the treatment works. With this assumption, the computed chlorine consumption for metro, class I and class II cities is presented as under :

|   |   |                              |
|---|---|------------------------------|
| 299 class I cities with 20,923 mld water supply | = | 2 x 20,923 x 365 kg per year |
|   | = | 15,274 Tonnes per year       |
| 345 class II cities with 2031 mld water supply  | = | 2 x 2031 x 365 kg per year   |
|   | = | 1,483 Tonnes per year        |

Total consumption of chlorine with a water supply of 22,954 mld for metro cities, class I cities and class II cities at their water treatment plants works out to be 16,757 T per year (1991)

For collecting the data on chlorine consumption and emissions in water treatment, a questionnaire was prepared and sent to the chief engineers of Public Health Engineering and Water Supply Departments to obtain the factual position so as to ascertain chlorine consumption in water treatment sector. The response received in respect of chlorine consumption of individual water treatment plants is presented at Annexure 9.1.

#### Losses:

It is observed from the questionnaire, that on an average 0.25 - 10% losses are reported when chlorine is used in the form of gaseous or liquid form and 5 - 25% losses reported when bleaching powder is used as disinfectant.

Assuming 5% losses in water treatment the total amount of unaccounted chlorine is 1303 T.

In order to minimise chlorine losses, the authority should identify and adopt the best practicable technology in all the water treatment plants of the country.

## 9.2 Wastewater Treatment

Wastewater generated from urban settlements has been the major source of pollution of surface waters. According to a survey by the CPCB, the estimated wastewater generation from 299 class I cities of India is 12,145 MLD (1991). Of this, only 2,485 MLD is receiving treatment, in some cases only partially. From 345 class II towns in India, an estimated 1,649 MLD of wastewater is generated (1991). Further, it is reported that only 4% of the total wastewater generated in class II towns is treated before letting out, the rest is disposed off untreated. The treated and untreated wastewater is disposed off into natural drains joining rivers or lakes or on land for irrigation / fodder cultivation or sea or combination thereof. Due to shortage of water, treated effluent is used in some of the industries after tertiary treatment. Although, use of chlorine for effluent disinfection is not reported, the wastewater disinfection with chlorine has major health impacts. Chlorine combines with the organic matter in water to produce organochlorine by-products. Among the best-understood are the carcinogenic trihalomethanes, including chloroform. Chlorinated effluents from sewage plants can cause severe damage to fish and aquatic ecosystems.

## 10.0 Dyes and Dye Intermediates Sector

Dyestuffs industry in India is nearly five decades old and has made rapid strides during this period and grown strongly in developed as well as developing countries.

The textile industry in the country consumes about 80 per cent of the dye manufactured and non-textile areas account for about 20 per cent.

The dyestuffs industry in the country has a strong base technology to manufacture almost all classes of colourants, skilled manpower available from a large reservoir of scientists and technologists and reasonably good raw material base. Collective efforts by industry, the Government and research institutions will lead this industry in the right direction for meeting future challenges. The dependence of dyestuffs industry predominantly on textiles, Leather, paper, plastics, paint and printing ink are other end users offering better growth opportunities. In India 16 types of dyes are manufactured. Dyes and dye intermediates sector accounts for more than half of the total export value of Indian chemical industry and has exhibited a phenomenal growth in last 15 years and the exports have increased from Rs. 100 Crores in 1986-87 to Rs. 7950 Crores in 2000-2001.

### 10.1 Status of the Dyes and Dye Intermediates

Presently, there are about 1050 units manufacturing various types of dyes and dye intermediates. Out of these, about 100 units are in the organised large sector and about 950 units are in small scale sector. The installed capacity for manufacturing dyes and dye intermediates is about 76,500 tonnes. The capacity utilisation is about 72 per cent. While organised sector contributes 65-70 per cent, small-scale sector has about 35 per cent share in the total production of dyes and dyestuffs.

The manufacture of various classes of dyestuffs is well established in India. The production of dyestuff and dye intermediates was 74,110 T and 1,68,862 T respectively during 1999-2000. The production of dyestuff in dyes and dyestuff industries is growing at the rate of 6.8% per annum in the country.

The Indian dyestuff industry produces about 94,000 TPA of dyes, which is approximately 5.0 - 6.0% of the total world output. About 56% of the production (i.e., 53,000 TPA) is being exported. With regard to dyes intermediates, the estimated production is 2,50,000 TPA and almost half of it is being exported.

The industries are mostly concentrated in the states of Maharashtra and Gujarat. Both the states account for more than 75% (Gujarath: 45% and Maharashtra: 30%) of the total production of dyes and dye intermediates in the country.

The per capita consumption of colourants was 63 g in the year 2000 and is below the world average of 200 g. The domestic consumption of colourants is 61,000 T in 2000, with reactive and disperse dyes showing higher growth potential. Reactive dyes show a growth rate of about 4% both in domestic and international market. The domestic demand for dyes in 2001-02 was 66,400 tonnes.

## 10.2 Chlorine Consumption

In India, 4 per cent chlorine is consumed in dye and dye intermediate sector. The chlorine consumption was 47,545 MT in 1996-97, 53,812 MT in 1998-99 and around 65,000 MT in 2001-02. The future chlorine consumption by dyes and dye intermediates depends on:

- Consumption of chloro compound for production of dye intermediates
- Demand of dyestuff from textile industry and other user sector
- Export pattern
- R&D Activities

## 10.3 Chlorine Emissions

- As such chlorine is lost in the atmosphere in the form of gas. Generally, Chlorine is being absorbed in caustic to prepare hypochlorite solution and hence the quantity going to the atmosphere is generally negligible. Occasionally, it may happen that some of the chlorine may escape to the atmosphere due to power failure or due to some maintenance problem
- Generally, chlorine is lost after scrubbing system. It has been reported that during the last stage of chlorination the reaction becomes slow and chlorine does not react with material and it escapes to scrubbing system. The Association reported that full-fledged scrubbing system has been provided and hence chlorine going to atmosphere is very negligible.

### Minimisation of Emissions

- Scrubbers for control gaseous pollutants should be properly operated & maintained. The scrubbers should be cleaned periodically to avoid its clogging. Scrubbed liquid should be treated along with the effluent from other sections.
- Losses of volatile matter from storage tanks can be minimized by providing condensers, absorbers and minimizing breathing losses.

## 10.4 Challenges and Future Trends

Some of the challenges confronting the dyestuff industry are :

- Modernisation of plants for greater operational efficiency
- Meaningful pollution control and environmental protection programmes and their successful implementation
- Consolidating and expanding the export market, guarding the interest of Indian dyestuffs manufacturers
- Development of non-benzidine substitutes for benzidine dyes, low cost cellulosic dyes, superior disperse dyes, and speciality dyes
- Rapid and effective transfer of laboratory processes to manufacturing technologies.

## Future Trends

The future trends in dyestuff industry will depend on the following :

- The industry will continue to grow and dyestuff consumption will increase worldwide, but the product mix is expected to be fluid depending on the fashion trends
- Economies will assume significance and overall efficiency will be taken up on priority to remain competitive in the international market
- In global marketing, extensive marketing research and time bound action plans will be the endeavour of the industry. Export opportunities will continue to exist but a stiff competition in quality, price and supply schedules is expected. Though continued dependence on exports is expected, since a deceleration in exports has currently been noticed, the industry will think it as a prudent strategic option to strengthen its base in the domestic market while continuing its efforts to consolidate and expand the export market
- Industrial safety and environment protection will remain the overriding factors in any new product and process commercialised
- Novel applications of dyes will be continuously explored and speciality dyes will assume importance. This has been advocated as a strategic option for the Western industry alongwith quality dyes and quality processes. In this age of information the dyes used in information technology will be commercially exploited.

## 11.0 Pharmaceuticals Sector

About 85% of all pharmaceuticals use chlorine at some point in their production process. These drugs include vitamins and medicines that treat Heart Diseases, Cancer, Ulcers, arthritis, Pneumonia, Depression, Diabetes, Allergies and Colds, Ear infection, Fungal diseases, Glaucoma, Hypertension, Inflammation, Pneumonia, Malaria and Meningitis to name a few. Some of the familiar medicines that are made using chlorine include:

- Acetaminophen, a widely used pain reliever
- XANAX®, one of the most prescribed anti-anxiety and medications
- Vancomycin, the only antibiotic to which 40 percent of staph infections respond and the only one effective against hospital staph infections
- LORABID® and CECLOR®, two of the most effective antibiotics for treating the severe middle ear infections that millions of children develop each year
- BENADRYL®, CHLOR-TRIMETON®, and other well-known decongestants and antihistamines

In addition, almost one-third of central nervous system drugs contain chlorine, and 98 percent of gastrointestinal medications are made using chlorine. Chlorine is also used in a wide variety of medical equipment. An estimated 25% of all medical devices in hospitals contain or are made with chlorine among them are I.V. and blood bags, x-ray and mammon-graphy film, syringes, oxygen tents, diagnostic instruments, steride tubing packing, coolers for organ transplant surgical sutures and artistical blood vessels. Methylene chloride and / or chloroform are very widely used as a solvent in pharmaceutical sector.

Chlorine-based vinyl packaging also adds to the safety of medicine. Vinyl is used to make the shrink bands commonly used on overt-the-counter products to alert consumers to evidence of tampering. Many pharmaceuticals also are supplied in vinyl packaging - such as the "blister" packs that help extend the shelf life of tablets and capsules and make it easier for patients to take the proper dosage.

Chloroquin, the main drug to fight malaria needs chlorinated solvent during the reaction. Antibiotics make up 30% of total drugs (Ampicillin, Amoxycillin, Cloxacillin, Cephadoxil, Cephalaxin). Ampicillin and Amoxycillin in the country are growing at the rate of 15% per annum. Per capita drug consumption in India is very low. Methylene chloride is widely used as a raw material for synthesis of Vitamin A.

## 12.0 Textile Industry Sector

The textile industries can be broadly classified in two groups, namely, cotton industry and woollen industry. The industries based on cotton and woollen fibers also include synthetic fiber blends.

The cotton textile has retained its dominant position not only because of its easy domestic availability but also due to the climatic conditions in the country which dictate the need for cotton based wear. The cotton textile industry is the second largest industry in India and is of great economic significance. It also supports a number of other industries like dyes, chemicals, packing material and handloom industry.

As per the data obtained from the Textile Commissioner's Office, there are 1569 textile industries in India, of these 1294 are spinning industries while 275 are composite industries. The state wise break-up of the number of spinning and composite industries is presented in Table 12.1. The state wise production of cotton, blended and 100% non-cotton cloth by mill sector is presented in Table 12.2.

### 12.1 Production Process

The processes employed by the textile industries are:

- |              |                           |
|--------------|---------------------------|
| i. Scutching | viii. Sizing              |
| ii. Carding  | ix. Desizing and Scouring |
| iii. Drawing | x. Bleaching              |
| iv. Combing  | xi. Mercerising           |
| v. Spinning  | xii. Dyeing               |
| vi. Winding  | xiii. Printing            |
| vii. Weaving | xiv. Finishing            |

### 12.2 Chlorine use in textile industry

In textile industry, chlorine compounds are used in bleaching process. The bleaching process is necessary whenever fabrics are to be given full white finish or where they are to be dyed in specific shades. Bleaching of polyester-cotton blend fabrics is mainly required for the cotton component. However, if pure white goods are to be marketed, the polyester component also requires a bleaching treatment as the polyester fibers have a slight coloration, as they are manufactured. The bleaching treatment also becomes essential if sighting colours, which are difficult to remove are used or the polyester fibers have turn yellow during heat setting. In bleaching process the natural colouring matter in the textile material is removed by the use of oxidizing chemicals.

Sodium hypochlorite, calcium hypochlorite and sodium chlorite are the chlorine compounds commonly used as bleaching agents in textile industry.

### 12.3 Quantity of chlorine required in bleaching

Quantities of chlorine compound (sodium chlorite) required for bleaching of various types of fiber are summarized in Table 12.3.

Table 12.1: Distribution of Textile Industries

| State / UT         | Number of Textile Industries |           |       |
|--------------------|------------------------------|-----------|-------|
|                    | Spinning                     | Composite | Total |
| Andhra Pradesh     | 88                           | 2         | 100   |
| Assam              | 3                            | 2         | 5     |
| Bihar              | 7                            | 2         | 9     |
| Goa                | 1                            | -         | 1     |
| Gujarat            | 48                           | 88        | 136   |
| Haryana            | 62                           | 2         | 64    |
| Himachal Pradesh   | 10                           | -         | 10    |
| Jammu & Kashmir    | 2                            | -         | 2     |
| Karnataka          | 42                           | 12        | 54    |
| Kerala             | 31                           | 4         | 35    |
| Madhya Pradesh     | 36                           | 15        | 51    |
| Maharashtra        | 106                          | 75        | 181   |
| Manipur            | 1                            | -         | 1     |
| Orissa             | 13                           | 1         | 14    |
| Punjab             | 34                           | 1         | 35    |
| Rajasthan          | 38                           | 7         | 45    |
| Tamil Nadu         | 692                          | 25        | 717   |
| Uttar Pradesh      | 48                           | 14        | 62    |
| West Bengal        | 22                           | 17        | 39    |
| Delhi              | -                            | 3         | 3     |
| Dadra Nagar Haveli | 1                            | -         | 1     |
| Daman & Diu        | 1                            | 2         | 3     |
| Pondicherry        | 8                            | 3         | 11    |

Source : Compendium of Textile Industries, 1996

Table 12.2: State wise Production of Cloth

| State / UT     | Cotton Cloth | Blended Cloth | 100% Non-Cloth Cotton | Total Cloth |
|----------------|--------------|---------------|-----------------------|-------------|
| Andhra Pradesh | 66           | -             | -                     | 66          |
| Assam          | -            | 100           | -                     | 100         |
| Bihar          | -            | -             | -                     | -           |
| Gujarat        | 248232       | 173804        | 29558                 | 4511594     |
| Haryana        | -            | 6123          | -                     | 6123        |
| Karnataka      | 26863        | 15213         | 193                   | 42269       |
| Kerala         | 16714        | 1612          | 2832                  | 21158       |
| Madhya Pradesh | 42811        | 7929          | -                     | 50740       |
| Maharashtra    | 535790       | 220140        | 1709                  | 757639      |
| Orissa         | 22531        | -             | -                     | 22531       |
| Punjab         | 24408        | 26579         | -                     | 50987       |
| Rajasthan      | 38352        | 18961         | -                     | 57313       |
| Tamil Nadu     | 81572        | 59908         | 18596                 | 160076      |
| Uttar Pradesh  | 21104        | 8296          | -                     | 29400       |
| West Bengal    | 36771        | 4079          | 1238                  | 42088       |
| Delhi          | 662          | 1             | -                     | 663         |
| Pondicherry    | 34360        | 741           | 1                     | 34832       |

Source : Compendium of Textile Statistics, 1996 (Production year 1995-96)

Note : Quantity is expressed in thousand sq. meter



## 12.4 Chlorine emissions in bleaching process

- Chlorine dioxide gas generated from the acidic solution of sodium chlorite during bleaching process carried out at high temperature of 80-95°C.
- Residual concentration of sodium chlorite in the wastewater discharged from bleaching process

### 12.4.1 Disadvantages of the Chlorine Bleaching

Whenever cotton fibers are acted upon by either calcium hypochlorite or sodium hypochlorite, a compound known as oxycellulose tends to form. This degradation product is objectionable in yarn or cloth because it causes tendering of the fibers, the developing of yellowish or brownish stains on storage and uneven dyeing. To keep the oxycellulose formation minimum, a careful chemical control at every step of the process and stopping the bleaching action before it has gone beyond a certain point are required. Formation of the oxycellulose can be avoided by using sodium chlorite in an acid solution instead of using hypochlorite in an alkaline solution. Sodium chlorite has sufficient oxidizing power to destroy all the coloring matter associated with cotton fiber. However, acid solution of sodium chlorite generates chlorine dioxide (ClO<sub>2</sub>) which has a great corrosive action on the materials of construction including stainless steel. Special material such as glass, porcelain, earthenware or some selected plastics are therefore required for fabricating machinery if sodium chlorite is to be used as a bleaching agent.

## 12.5 Alternatives for chlorine chemicals in bleaching process

Hydrogen peroxide is the major bleaching chemical for textiles. Bleaching with hydrogen peroxide is a well established process in textile industry. However, optimized bleaching is often dependent on processing conditions that can sometimes be detrimental to fiber quality, typically through the use of high temperatures, high pH values or extended reaction times. Recent studies undertaken by Warwick International Ltd. indicate that using TAED (tetra-acetyl-ethylenediamine) as a peroxide activator into the bleach bath, peroxide bleaching can be performed at both lower temperatures and alkalinity with significant benefits in terms of retained fiber quality. TAED is colourless, odourless, storage stable, safe and easy to handle. It has been established as a non-toxic, non-sensitising, non-mutagenic product which biodegrades to form CO<sub>2</sub>, water ammonia and nitrate.

Table 12.3: Use of Sodium Chlorite in Bleaching of Textile

| Sl. No. | Material  | Liquor: Material | Sodium Chlorite                         | pH Value of Liquor and Acid to be Used                  | Bleaching   |
|---------|---|------------------|---|---|---|
| 1.      | Loose cotton (1000 kg)  | 5 : 1            | 20 kg                                   | 5 : Sulphuric acid 1:10                                 | 3.5 hours at 80-85°C (176-185°F), heating in first 2 hours from 40-80°C (104-176°F)                                     |
| 2.      | Cotton yarn (1000 kg) Mercerised treated with hydrochloric acid and rinsed      | 4 : 1            | 16 kg                                   | 3.8-4.0; Formic acid or acetic acid                     | 3 hours at 85°C (185°F), heating in first 2 hours from 40-85°C (104-185°F)  |
| 3.      | Cotton cheese 34/2 (250 kg)   | 12 : 1           | 47 kg                                   | 3.5-3.8 Formic acid or acetic acid                      | 1 hour at 90-95°C (194-203°F) heating in first 30 minutes from 40-90°C (104-194°F)                                      |
| 4.      | Viscose staple fibre (100 kg)   | 20 : 1           | 1.6 gm                                  | 3.5 ; Formic acid 85%                                   | 20-30 minutes at 80-85°C (176-185°F)  |
| 5.      | Viscose muslin (3000 kg) Continuous bleach                                      | 25 : 1           | 12 kg                                   | 3.5 ; Formic acid 85%                                   | Speed of goods : 70 m/minutes. Treatment time : 15 minutes. Total bleaching time 15 minutes. Temperature : 85°C (185°F) |
| 6.      | Viscose staple fabric (2000 kg) enzymatically, desized, scored on a rope soaper | 4 : 1            | 8 kg                                    | 3.5-3.8 Formic acid 85%                                 | Heat to 75-80°C (167-176°F) and bleach for 1 hour at this temperature   |
| 7.      | Visco filament and acetate filament union fabrics (100 kg)                      | 4 : 1            | 640 gm                                  | 3.5-3.8 Formic acid 85%                                 | 4-5 passages at 75-80°C (167-176°F)   |
| 8.      | Nylon fabric (50 kg)  | 8 : 1            | 12.5 gm                                 | 4-6 passages at 80-85°C (167-176°F)                     | 4-6 passages at 80-85°C (176-185°F)   |
| 9.      | Perlon Soiled (50 kg)   | 30 : 1           | 1.2 kg                                  | 3.8 ; Acetic  | Heat in 30 minutes from 40-85° (104-203°F); 30 minutes 85°C (185°F)   |
| 10.     | Acrylic fibres  | 30-40:1          | 1.2 - 2.0 g/l Solution added in portion | 2.5-3.0; Oxalic acid 1-2 g/l, solution added in portion | Heat in 30 minutes from 40-95° (104-203°F); 30 minutes 95-98°C (203-208°F)  |
| 11.     | Polyester fibres  |                  | 1.2 - 2.0 g/l Added in portion          | 1.0-3.0; Oxalic acid 1-2 g/l, solution added in portion | Heat in 30 minutes from 40-95° (104-203°F); 30 minutes 95-98°C (203-208°F)  |

## 13.0 Conclusion and Recommendations

### 13.1 Environmental significance of chlorine and its compounds

Environmental significance of chlorine and its compounds can be understood by broadly classifying these compounds into following four categories:

- (i) Chlorine compounds products that are themselves of concern because of their toxic and persistent nature such as:
  - Organo-chlorine pesticides
  - PCBs : These are used as dielectric fluids, hydraulic and heat transfer fluids, and as ingredients in manufactured products such as in extruded plastic and rubber products from use of PCB oil as an extrusion lubricant;
  - HCB : It is used as a pesticide and also as an industrial chemical in the production of fireworks, ammunition, rubber, aluminium, and dyes, and in wood preservation;
  - Chlorinated-paraffins, CP : A large number of CP formulations are in use for a wide range of industrial applications, such as flame retardants and plasticiser, and as additives in metal working fluids, in sealants, paints and coatings;
  - Chlorinated solvents : Methylene chloride, Perchloroethylene and Trichloroethylene are the most commonly used solvents. Methylene chloride is used in pharmaceuticals, chemical processing, aerosols, food extraction, urethane foam blowing and surface treatment including paint stripping; Perchloroethylene is used in dry cleaning and metal cleaning; and Trichloroethylene is used in metal cleaning and speciality adhesives;
  - Bleached paper : This is because organochlorines including dioxins, furans and other highly toxic, persistent substances are expected to be present in the final product (bleached paper); and
  - PVC : This is because of release of organochlorines and other chemicals, such as the hormone-disrupting phthalates from PVC products throughout their life cycle.
- (ii) Toxic and persistent chlorine compounds products that are released into environment unintentionally from the processes involving use of chlorine or chlorine compounds. These include:
  - Release of toxic substances, including EDC and VCM, and byproducts into the environment in the PVC manufacturing process;
  - Release of HCB formed as a by-product during the manufacture of chemicals used as solvents, pesticides and chlorine-containing compounds, and in the waste streams of chlor-alkali and wood-preserving plants, and burning of municipal wastes;

- Release of organochlorines in the liquid effluents / solid wastes generated from manufacture processes such as Pulp & Paper mills' effluent; and
  - Release of organochlorine byproducts (predominantly, trihalomethanes) formed due to combination of chlorine and organic matter during disinfection of water and wastewater.
- (iii) Toxic and persistent chlorine compounds products that are released into environment when some chlorine compounds are disposed in unsafe manner. Some examples of these are:
- Formation of dioxins when PVC products / waste are burned in waste incineration or in accidental fires;
  - Formation of furans when PCB products / wastes are burned by waste incineration or in accidental fires;
  - Release of HCB in the waste streams of chlor-alkali and wood-preserving plants, and when burning municipal waste; and
  - Release of PCBs during recycling of ships breaking wastes (paint, electric cables etc.).
- (iv) Chlorine and its compounds that are releases in the form of gaseous emissions or air pollutants but are not persistent such as release/loss of chlorine and HCl in Chlor-Alkali, chlorinated-paraffins, dyes & dyes intermediate, pharmaceutical, PVC, Pulp & Paper, organic chemicals, inorganic chemical and textile industries and water & wastewater disinfection process etc.

## 13.2 Strategies to minimize environmental implications of chlorine and its compounds

### 13.2.1 Sectorwise Recommendations

The recommendations in respect of the strategies to be taken for minimization of the release of chlorine and its compounds are given sector-wise in Chapters 2 to 12.

### 13.2.2 General Recommendations

The strategies to minimize environmental implications of chlorine and its compounds are also categorized accordingly as below:

- (i) Elimination of use of chlorine compounds / products which are of toxic / persistent nature and substitution of these products with environmentally safe substances wherever possible. Recycling to maximum extent of those substances whose elimination is not immediately expected due to absence of alternative is also a solution to greatly reduce release of these toxic / persistent substances. Following chlorine compounds require elimination of use and recycling:
- Organo-chlorine pesticides;
  - PCBs;
  - HCB (as an industrial chemical);
  - Chlorinated-paraffins;
  - Chlorinated solvents; and

- Paper manufactured from Chlorine bleaching

Use of most of the organo-chlorine pesticides has already been banned in agriculture and PCBs are also being phased out. Complete ban on remaining organo-chlorine pesticides covered under 12+6 identified POPs for priority action and PCBs should be achieved in a time bound manner.

Paper manufactures to be asked to adopt chlorine free bleaching to achieve stringent AOX standards, which will also minimize release of chlorine compounds through paper.

Action is required for minimizing use of HCB and chlorinated-paraffins. Action is also required to adopt close-loop system in chlorinated solvents use to maximize recycling.

- (ii) Taking measure to minimize unintentional release of toxic and persistent chlorine compounds products into environment from the processes. These include the following:

- Reducing the release of toxic substances such as EDC, VCM and other byproducts from PVC manufacturing process to internationally permissible levels;
- Reducing the release of HCB formed as a by-product during the manufacture of chemicals used as solvents, pesticides and chlorine-containing compounds by insatlling waste gas incinerators;
- Reducing the release of organochlorines in the liquid effluents / solid wastes by process modification such as by adopting chlorine free bleaching in paper mills; and
- Reducing the formation of organochlorine byproducts that are formed due to combination of chlorine and organic matter during disinfection of water and wastewater will require removing as much organic matter as possible from water and wastewater before the disinfection stage. This may require shifting of pre-chlorination to after clariflocculation stage in water purification if the raw water contains high organic matter and will require treatment of wastewater to higher quality if disinfection is to be provided before disposal.

- (iii) Safe handling and disposal of chlorine compounds products that may release toxic and persistent chlorine compounds into environment if disposed in unsafe manner. Waste comprising or contaminated with PVC, PCBs, HCB must be disposed of in environmentally sound manner e.g. disposal in secured landfill sites or incineration in suitably designed incinerators.

- (iv) Minimizing release of chlorine and its compounds that are released in the form of gaseous emissions or air pollutants such as release / loss of chlorine and HCl in Chlor-Alkali, chlorinated-paraffins, dyes & dyes intermediate, pharmaceutical, PVC, Pulp & Paper, organic chemicals, inorganic chemical and textile industries and water & wastewater disinfections process etc. In some industries this may be achieved through formulation and implementation of emission standards, both concentration and load based

which will require the industry to install and operate properly its emission control system. Whereas in other industries / processes, such as Pulp & Paper, Textile and Water & Wastewater disinfection, it may be achieved through optimization of the use of chlorine.

### 13.3 Activities / Areas Identified for further Study

- (i) Coordinated action with industry associations to minimize use of chlorinated paraffins and substituting with alternative chemicals such as oxy-alcohols,
- (ii) Coordinated action with industry associations to minimize use of HCB and substituting with alternative safe chemicals,
- (iii) Development of guidelines for recycling of chlorinated solvents in selected industry sectors,
- (iv) Development of guidelines for safe recycling of PVC wastes,
- (v) Development of guidelines for identification and safe disposal of PCBs, chlorinated paraffins and chlorinated solvents wastes,
- (vi) Development of guidelines for identification of processes requiring waste gas collection and incineration in selected industrial sectors such solvents, pesticides and other chlorine-containing compounds for the control of HCB and other organo-chlorine compound emissions formed as a by-product during the manufacture process,
- (vii) Development of concentration as well as mass based emission standards for EDC and VCM emission from PVC industry, and
- (viii) Development of concentration as well as mass based emission standards for chlorine and HCL emission from chlor-alkali and other selected industrial sectors

## Properties of Chlorine

### 1) Physical Properties:

|                   |   |                 |
|-------------------|---|-----------------|
| Molecular Formula | = | Cl <sub>2</sub> |
| Molecular Weight  | = | 70.914          |
| Atomic Weight     | = | 35.457          |

**Boiling Point** : -29.29°F (-34.05°C)

It is the temperature at which liquid Chlorine vaporizes under one atmosphere.

**Melting Point** : 149.8°F (-101.0°C)

It is the temperature at which liquid chlorine solidifies under one atmosphere.

#### Density :

|           |  |
|-----------|--|
| Dry Gas - | 3.209 g/L at 0°C & 1 Atmosphere                      |
| Liquid -  | 1.468 kg/L (Pressure of liquid at 0°C is 3.617 atm.) |

Density represents the mass of a unit volume at specified temperature and pressure conditions. Density decreases rapidly with increasing temperature. Chlorine gas is about 2.5 times heavier than air at the same condition.

#### Heats of Fusion and Vaporization :

|   |   |              |
|---|---|--------------|
| Heat of Fusion (at melting point)       | = | 22.9 g cal/g |
| Heat of Vaporization (at boiling point) | = | 68.7 g cal/g |

It is the heat required to change one mass of solid Chlorine to liquid (heat of fusion) or to change one mass of liquid to vapour (heat of vaporization) without change of temperature.

**Viscosity** : It is a measure of internal molecular friction when a substance is in motion. The viscosity of Cl<sub>2</sub> gas is nearly the same as that of saturated steam between 1 and 10 atmosphere : that of liquid Cl<sub>2</sub> is about one third that of water at the same temperature. Hence, its friction loss in pipelines is definitely lower than that of water.

#### Specific Volume :

|         |   |   |
|---------|---|---|
| Dry gas | : | 4.992 ft <sup>3</sup> /lb at 0°C and 1 atm. pressure (0.31098 m <sup>3</sup> /kg) |
| Liquid  | : | 0.01091 ft <sup>3</sup> /lb at 0°C and 3.617 atmospheric pressure                 |

It is the volume of unit mass of Cl<sub>2</sub> at specified condition of temperature and pressure.

**Liquid-Gas Volume Relationship** : Liquid Cl<sub>2</sub> vaporizes rapidly at Standard atmospheric conditions. One volume of liquid vaporises into about 457.6 Volume of gas, or one lb (0.453 kg) of liquid forms about 5 m<sup>3</sup> (0.1415 m<sup>3</sup>) of gas.

**Volume and Temperature Relationship** : The volume of liquid Cl<sub>2</sub> increases rapidly as its temperature increases. The volume-temperature relationship of liquid Cl<sub>2</sub> in a container loaded to its authorized limit is as follows:

|                         |       |       |      |       |       |       |       |       |
|-------------------------|-------|-------|------|-------|-------|-------|-------|-------|
| Temperature             |       |       |      |       |       |       |       |       |
| °F                      | 10.00 | 0.00  | 20.0 | 60.0  | 100.0 | 120.0 | 160.0 | 200.0 |
| °C                      | 23.00 | -32.0 | -6.6 | 15.55 | 37.7  | 48.88 | 70.11 | 93.33 |
| % Volume<br>(as liquid) | 81.4  | 82.1  | 84.4 | 87.7  | 92.3  | 94.8  | 97.7  | 100   |

## Vapour Pressure:

It is the pressure of Cl<sub>2</sub> gas above liquid Cl<sub>2</sub> when they are in equilibrium. The relation between vapour pressure and temperature is as follows:

|                    |       |       |       |       |       |       |        |       |
|--------------------|-------|-------|-------|-------|-------|-------|--------|-------|
| Temperature        |       |       |       |       |       |       |        |       |
| °F                 | 29.29 | 10.00 | 0.00  | 20.0  | 60.0  | 100.0 | 160.0  | 200.0 |
| °C                 | 34.05 | 23.00 | -32.0 | -6.6  | 15.55 | 37.7  | 70.11  | 93.33 |
| Vapour Pressure    |       |       |       |       |       |       |        |       |
| PSI                | 0     | 8.29  | 13.81 | 27.84 | 70.91 | 140.2 | 310.35 | 480.9 |
| Kg/cm <sup>2</sup> | 0     | 0.56  | 0.93  | 1.89  | 4.82  | 9.54  | 21.12  | 32.7  |

## Critical Properties :

- The critical density (573 g/L) is the mass of a unit volume of Chlorine at the critical pressure and temperature.
- The critical pressure (76.1 atmosphere) is the vapour pressure of liquid Chlorine at the critical temperature.
- The critical temperature (144°C) is the temperature above which chlorine exists only a gas despite the pressure.
- The critical volume (1745 ml/g) is the volume of a Unit mass of Chlorine at the critical pressure and temperature. It is the reciprocal of critical density.

**2) Chemical Properties :** Chlorine is neither flammable nor combustible but it is highly reactive material. It reacts rapidly with most elements, many inorganic and organic compounds, in some cases with explosive violence and frequently with evolution of heat.

**Reactions with water :** When it is dissolved in water between 9.6°C and 100°C, it reacts to form hypochlorous acid (HOCl) and hydrochloric acid (HCl).

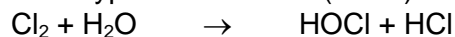

The formation of HOCl and HCl acids explain why moist chlorine has a corrosive effect on metals which ordinarily are unaffected by gas or liquid Chlorine.

## Reaction with gases :

**Ammonia :** It reacts with NH<sub>3</sub> as follows :

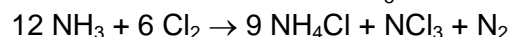

It may react in aqueous ammonia solution to form various Chloramines or mixtures of Chloramines.

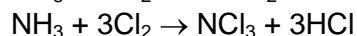
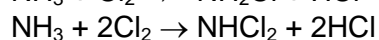
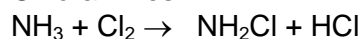

**Hydrogen :** It reacts with H<sub>2</sub> slowly in dark but explosively in sunlight or at high temperature to form Hydrogen Chloride (H<sub>2</sub> + Cl<sub>2</sub> → 2 HCl).

The lower explosive limit of Hydrogen - Chlorine mixture varies from 3.1% to 81% depending upon pressure and other variables.

**Oxygen :** Chlorine does not react directly with O<sub>2</sub> but several Oxides are formed by using indirect means.

**Hydrogen sulfide:** Cl<sub>2</sub> reacts with H<sub>2</sub>S, and Chloroxidation processes for odour control are frequently employed.



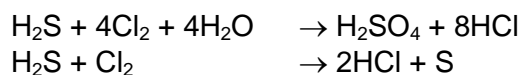

**Sulfur Dioxide** : Dechlorination with  $\text{SO}_2$  is based on this reaction :

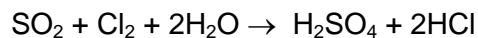

**Reactions with Metals and other Elements** : Under certain conditions,  $\text{Cl}_2$  reacts with nearly all metals to form metal Chlorides which are usually quite soluble in water (Cuprous, Silver, Plumbous, Mercurous, platinous, Thallous are only slight soluble). Below  $110^\circ\text{C}$ , Copper, iron, lead, nickel, platinum, silver, Steel are chemically resistant to dry Chlorine, gas or liquid. The reaction rate of  $\text{Cl}_2$  with most metals increases with extreme rapidity above certain temperatures. Dry  $\text{Cl}_2$  reacts with Aluminium, Arsenic, Gold, Mercury, Selenium, Tellurium, Tin and Titanium.



At certain temperature potassium and sodium burn in  $\text{Cl}_2$  gas. Carbon steel ignites at  $250^\circ\text{C}$ . Antimony, Arsenic, Bismuth, Boron, Copper, Iron, Phosphorus, and certain of their alloys, in powdered, sponge or wire in finely divided form, ignite spontaneously in  $\text{Cl}_2$ .

Moist chlorine, primarily because of  $\text{HCl}$  and  $\text{HOCl}$  formed through Hydrolysis is very corrosive to all common metals. Gold, platinum, Silver and Titanium are resistant. At temperature below  $140^\circ\text{C}$ , Tantalum is totally inert to wet and dry Chlorine. Moist and dry chlorine reacts readily with Mercury.

**Reactions with Inorganics** : Chlorine reacts with many inorganic compounds like Calcium Carbonate, Calcium Borate, Ammonium Chloride, Carbon Mono Oxide,  $\text{H}_2\text{O}_2$ ,  $\text{FeSO}_4$ ,  $\text{MgSO}_4$ ,  $\text{HgO}$ ,  $\text{NO}$ ,  $\text{KClO}$ ,  $\text{KCN}$ ,  $\text{KOH}$ ,  $\text{NaOH}$ ,  $\text{AgF}$ ,  $\text{AgNO}_3$ ,  $\text{NaHSO}_3$ ,  $\text{NaClO}_2$  etc.

**Reactions with Organics** : In the organic and Petrochemicals field  $\text{Cl}_2$  is most widely used as a chemical intermediate. There are thousands of Chlorine containing organic compounds of commercial importance are made by chlorinating hydrocarbons. In most instances, the reaction is very rapid and gives off heat.

**Solubility in Water** : Chlorine is only slightly soluble in  $\text{H}_2\text{O}$ , reaching its maximum solubility of approximately one per cent at  $49.3^\circ\text{F}$  ( $9.6^\circ\text{C}$ ). Below  $49.3^\circ\text{F}$  ( $9.6^\circ\text{C}$ ), it forms crystalline Hydrate with  $\text{H}_2\text{O}$  ( $\text{Cl}_2 \cdot 8\text{H}_2\text{O}$ ), referred to as "Chlorine ice". Above  $49.3^\circ\text{F}$  its solubility decreases when temperature increases upto boiling point of water at which it is completely insoluble.

### **Hazards of Chlorine :**

**Toxicity of  $\text{Cl}_2$**  : Chlorine is corrosive. It reacts with body moisture to form corrosive acids.  $\text{Cl}_2$  gas is primarily a respiratory irritant. It is irritating at concentration above 3 to 5 ppm by volume in air or readily detectable by a normal person. Inhalation of  $\text{Cl}_2$  can cause respiratory injury ranging from irritation to death depending upon its concentration and duration of inhalation.

**Acute effect of  $\text{Cl}_2$**  : The first symptom of exposure to  $\text{Cl}_2$  is irritation to the mucous membrane of eyes, nose and throat with increase in burning pain. If the duration of exposure of the concentration of  $\text{Cl}_2$  is excessive, it will cause restlessness, throat irritation and sneezing. In extreme cases lung tissues may be attacked resulting in pulmonary adema, fall of blood pressure.

### Effect of Cl<sub>2</sub> at Various Concentrations :

| Cl <sub>2</sub> Concentration in air (ppm) | Effect   |
|--|--|
| 0.2 - 0.5                                  | No noxious long term effect                            |
| 0.5  | Slight odour   |
| 1 to 3                                     | Definite odour, irritation to eyes                     |
| 6  | Irritation of throat                                   |
| 30   | Intense cough fits                                     |
| 40 – 60                                    | Exposure for 30 to 60 minutes may cause serious damage |
| 100  | May cause lethal damage                                |
| 1000                                       | Danger to life even after few deep inhalations         |

**Chronic effect :** In small concentration men rapidly lose their ability to detect the smell of Cl<sub>2</sub> gas therefore concentration higher than TLV (Threshold Limit Value) of 1 ppm may occur without immediate notice. Due to prolonged exposure to concentration more than 5 ppm bronchial problem and T.B may result, enamel of teeth may get damaged.

## Annexure 2.1

**Table A: Salt Production and Consumption by Chlor-Alkali Industry (Lakh MT)**

| Year | Salt Demand |                |        |        | Salt Production | Alkalies Production* |
|------|-------------|----------------|--------|--------|-----------------|----------------------|
|      | Edible Use  | Industrial Use | Export | Total  |                 |                      |
| 1994 |             |                |        |        | 123.0           | 27.0                 |
| 1995 | 48.49       | 55.91          | 5.16   | 109.56 | 125.0           | 29.0                 |
| 1996 | 53.96       | 62.66          | 5.47   | 122.09 | 144.6           | 30.6                 |
| 1997 | 57.35       | 55.56          | 5.31   | 118.22 | 142.5           | 31.0                 |
| 1998 | 51.34       | 59.07          | 4.06   | 114.48 | 119.6           | 29.7                 |
| 1999 | 78.22       | 58.00          | 8.28   | 144.50 | 144.5           | 31.99                |
| 2000 | 52.21       | 68.10          | 10.56  | 130.87 | 156.5           | 34.03                |
| 2001 | 51.96       | 66.58          | 10.90  | 151.25 |                 |                      |

\*Consumption of Salt @ 1.8 MT / MT of Alkali Production

Source: Alkali Manufacturer's Association of India, Annual Report 2000-01

**Table B: Unit-wise Installed Capacity and Production of Caustic Soda during 1996-2006**

| Unit         | Installed Capacity (MT/yr)<br>March 31, 2006 |              |                | Actual Production (MT/yr) |              |              |              |              |         |
|--------------|--|--------------|----------------|---------------------------|--------------|--------------|--------------|--------------|---------|
|              | Membrane Cell                                | Mercury Cell | Total          | 1996-97                   | 1997-98      | 1998-99      | 1999-00      | 2000-01      | 2005-06 |
| CA-1         | 118500                                       |              | 118500         | 46067                     | 35281        | 23703        | 52117        | 60935        | 96325   |
| CA-2         | 11550  | 10800        | 22350          | 12942                     | 16081        | 11465        | 12804        | 14655        | 17649   |
| CA-3         | 78750  |              | 78750          | 37698                     | 38976        | 38963        | 41091        | 44012        | 48267   |
| <b>CA-4</b>  |  | <b>59400</b> | <b>59400*</b>  | <b>52785</b>              | <b>49773</b> | <b>48742</b> | <b>49750</b> | <b>50256</b> |         |
| CA-5         | 13200  |              | 13200          | 11500                     | 11000        | 8500         | 8000         | 8000         | 5000    |
| CA-6         | 20000  |              | 20000          | 15314                     | 15800        | 15400        | 15636        | 16239        | 18314   |
| <b>CA-7</b>  | <b>38700</b>                                 |              | <b>38700*</b>  | <b>17937</b>              | <b>19309</b> | <b>21766</b> | <b>27751</b> | <b>30532</b> |         |
| CA-8         |  | 46200        | 46200          | 43635                     | 39372        | 45340        | 47230        | 47755        | 46988   |
| CA-9         |  | 60000        | 60000          | 45724                     | 58754        | 47763        | 57589        | 57261        | 60100   |
| CA-10        | 117250                                       |              | 117250         | 39622                     | 38578        | 38664        | 38782        | 43011        | 83850   |
| CA-11        | 70445  |              | 70445          | 31000                     | 40077        | 44490        | 44647        | 42126        | 65497   |
| CA-12        |  | 10500        | 10500          | 7155                      | 7216         | 8539         | 7084         | 9184         | 11051   |
| CA-13        | 108000                                       | 82800        | 190800         | 122837                    | 129721       | 130049       | 135260       | 131268       | 165509  |
| CA-14        | 270000                                       |              | 270000         | 165080                    | 146900       | 141650       | 242533       | 227055       | 296686  |
| <b>CA-15</b> | <b>100000</b>                                |              | <b>100000*</b> |                           | <b>2539</b>  | <b>74000</b> |              |              |         |
| CA-16        |  | 14760        | 14760          | 12459                     | 13066        | 11922        | 9847         | 9687         | 11232   |
| CA-17#       |  | 36500        | 36500          | 15000                     |              |              | 9102         | 18116        | 27668   |
| <b>CA-18</b> | <b>20000</b>                                 |              | <b>20000*</b>  |                           | <b>5694</b>  | <b>7285</b>  | <b>769</b>   | <b>**</b>    |         |
| CA-19        | 15660  | 36680        | 52340          | 39335                     | 35081        | 33799        | 30481        | 29881        | 33123   |
| CA-20        | 79200  |              | 79200          |                           | 13882        | 17085        | 27420        | 30622        | 57058   |

| Unit         | Installed Capacity (MT/yr)<br>March 31, 2006 |               |                | Actual Production (MT/yr) |                |                |                |                |                |
|--------------|--|---------------|----------------|---------------------------|----------------|----------------|----------------|----------------|----------------|
|              | Membrane Cell                                | Mercury Cell  | Total          | 1996-97                   | 1997-98        | 1998-99        | 1999-00        | 2000-01        | 2005-06        |
| CA-21        | 160000                                       |               | 160000         |                           | 73000          | 111285         | 111456         | 126716         | 164463         |
| CA-22        |  | 22500         | 22500          | 22548                     | 20429          | 13724          | 10986          | 17421          | 22846          |
| <b>CA-23</b> | <b>33000</b>                                 |               | <b>33000*</b>  | <b>13385</b>              | <b>11891</b>   | <b>4996</b>    |                | <b>**</b>      |                |
| CA-24        | 38500  | 52000         | 90500          | 50283                     | 50023          | 46334          | 48120          | 44213          | 48656          |
| <b>CA-25</b> | <b>19800</b>                                 |               | <b>19800*</b>  |                           | <b>7129</b>    | <b>16670</b>   | <b>17940</b>   | <b>19116</b>   |                |
| <b>CA-26</b> | <b>125000</b>                                |               | <b>125000*</b> |                           | <b>24940</b>   | <b>48956</b>   | <b>36952</b>   | <b>35163</b>   |                |
| <b>CA-27</b> | <b>26250</b>                                 | <b>64750</b>  | <b>91000*</b>  | <b>67813</b>              | <b>70655</b>   | <b>45455</b>   |                | <b>4500</b>    |                |
| <b>CA-28</b> |  | <b>7590</b>   | <b>7590*</b>   | <b>5000</b>               | <b>5000</b>    | <b>4500</b>    |                |                |                |
| CA-29        | 56000  |               | 56000          | 52257                     | 18475          | 15637          | 24072          | 24677          | 32273          |
| <b>CA-30</b> |  | <b>3292</b>   | <b>3292*</b>   | <b>3351</b>               | <b>1853</b>    | <b>1045</b>    |                |                |                |
| CA-31        | 99000  |               | 99000          | 74433                     | 73805          | 64129          | 82646          | 7678           | 95312          |
| <b>CA-32</b> | <b>64800</b>                                 |               | <b>64800*</b>  | <b>26582</b>              | <b>42115</b>   | <b>38199</b>   | <b>47395</b>   | <b>46884</b>   |                |
| <b>CA-33</b> | <b>13200</b>                                 |               | <b>13200*</b>  | <b>12616</b>              | <b>12000</b>   | <b>71</b>      | <b>7294</b>    | <b>6312</b>    |                |
| CA-34        | 82500  |               | 82500          |                           |                | 12454          | 41323          | 52534          | 69301          |
| <b>CA-35</b> |  |               | <b>7241@*</b>  | <b>(3242</b>              | <b>2773</b>    | <b>2665</b>    | <b>2922</b>    | <b>3105</b>    |                |
| <b>CA-36</b> | <b>49500</b>                                 | <b>33000</b>  | <b>82500*</b>  | <b>65317</b>              | <b>58735</b>   | <b>54069</b>   | <b>39471</b>   | <b>51461</b>   |                |
| <b>CA-37</b> | <b>82700</b>                                 |               | <b>82700*</b>  | <b>54047</b>              | <b>63980</b>   | <b>61522</b>   | <b>59206</b>   | <b>52099</b>   |                |
| CA-38        | 94550  |               | 94550          | 92051                     | 83175          | 72506          | 65486          | 62762          | 66536          |
| CA-39        | 36000  |               | 36000          | 21302                     | 24108          | 14141          | 6703           | 8797           | 14212          |
| CA-40        | 49500  |               | 49500          | 38882                     | 37321          | 54111          | 54144          | 58631          | 51004          |
| CA-A         |  | 59400         | 59400          |                           |                |                |                |                | 46115          |
| CA-B         | 64800  |               | 64800          |                           |                |                |                |                | 56509          |
| CA-C         | 40250  |               | 40250          |                           |                |                |                |                | 19463          |
| CA-D         | 51000  |               | 51000          |                           |                |                |                |                | 36931          |
| CA-E         | 56100  |               | 56100          |                           |                |                |                |                | 59172          |
| <b>Total</b> | <b>2303705</b>                               | <b>600172</b> | <b>2911118</b> | <b>1315957</b>            | <b>1398507</b> | <b>1451594</b> | <b>1514009</b> | <b>1492664</b> | <b>1827110</b> |

@Diaphragm cell process \*March 2001 production capacity data \*\* Production closed #Two industrial units

**Table 2.1: Installed Capacity and Capacity Utilisation of Chlor-Alkali Industry**

| Year    | Installed Capacity (MT)<br>(in terms of NaOH) | Production (MT)<br>(NaOH) | Capacity<br>Utilisation (%) |
|---------|---|---------------------------|-----------------------------|
| 1994-95 | 15,19,000                                     | 12,07,400                 | 79                          |
| 1995-96 | 16,73,000                                     | 13,08,700                 | 78                          |
| 1996-97 | 19,14,000                                     | 13,20,000                 | 69                          |
| 1997-98 | 20,28,500                                     | 14,16,800                 | 69.8                        |
| 1998-99 | 22,72,100                                     | 14,92,200                 | 65.7                        |
| 1999-00 | 22,51,100                                     | 15,14,000                 | 67                          |
| 2000-01 | 22,51,100                                     | 15,61,800                 | 69                          |

Source : Alkali Manufacturers' Association of India, Annual Report 2000-01

## Annexure 2.2

## Chlorine Production and Utilization in India 1998-99 and 2000-01)

| Unit              | Chlorine Production (TPA) |         | Chlorine Segment             | Chlorine Utilisation |           |          |         |
|-------------------|---------------------------|---------|------------------------------|----------------------|-----------|----------|---------|
|                   | 1998-99                   | 2000-01 |                              | Quantity (TPA)       |           | Per cent |         |
|                   |                           |         |                              | 1998-99              | 2000-01   | 1998-99  | 2000-01 |
| CA-1              | 35,058                    | 53,623  | Liquid Chlorine              | 21,793.00            | -         | 97       | 96      |
|                   |                           |         | Hydrochloric Acid            | 8,520.00             | -         |          |         |
|                   |                           |         | Chloro- Sulphonic Acid       | 3,547.00             | -         |          |         |
|                   |                           |         | Sodium- Hypochlorite         | 276.00               | -         |          |         |
|                   |                           |         | Paper Units                  | -                    | 24,017.00 |          |         |
|                   |                           |         | PVC Units                    | -                    | 1,214.00  |          |         |
|                   |                           |         | CPW Units and Drugs          | -                    | 5,134.00  |          |         |
|                   |                           |         | Pesticides                   | -                    | 1,195.00  |          |         |
|                   |                           |         | Other Sectors                | -                    | 2,639.00  |          |         |
|                   |                           |         | Capitive Consumption         | -                    | 57.00     |          |         |
|                   |                           |         | Others                       | -                    | 17,000.00 |          |         |
|                   |                           |         | 34,136.00                    | 51,256.00            |           |          |         |
| CA-3              | 34,034                    | 38,467  | HCl                          | 15,641.00            | -         | 100      | 99      |
|                   |                           |         | Self Consumption Paper Inds. | 390.00               | 5,495.00  |          |         |
|                   |                           |         | CPW                          | 4,549.00             | 10,596.00 |          |         |
|                   |                           |         | Pesticides                   | 8,941.00             | 302.00    |          |         |
|                   |                           |         | Water Treatment              | 1,044.00             | 2,146.00  |          |         |
|                   |                           |         | SBP                          | 1,432.00             | 38.00     |          |         |
|                   |                           |         | Organics                     | -                    | 1,356.00  |          |         |
|                   |                           |         | Other Chemicals              | 2,151.00             | 18,000.00 |          |         |
|                   |                           |         | 34,148.00                    | 37,933.00            |           |          |         |
| CA-4<br>(3 units) | 43,802                    | 44,225  | Pesticides                   | 1,102.00             | 1,102.00  | 99       | 97      |
|                   |                           |         | Paper                        | 7,043.00             | 7,043.00  |          |         |
|                   |                           |         | Rayon / Pulp                 | 1,204.00             | 1,204.00  |          |         |
|                   |                           |         | Water Treatment              | 469.00               | 469.00    |          |         |
|                   |                           |         | EDC / PVC                    | 2,942.00             | 2,942.00  |          |         |
|                   |                           |         | Black Powder                 | 743.00               | 743.00    |          |         |
|                   |                           |         | Others                       | 653.00               | 653.00    |          |         |
|                   |                           |         | Textiles                     | 604.00               | 604.00    |          |         |
|                   |                           |         | CPW                          | 32.00                | 32.00     |          |         |
|                   |                           |         | HCl                          | 28,534.00            | 28,534.00 |          |         |
|                   |                           |         | 43,326.00                    | 43,326.00            |           |          |         |
| CA-6              | 25,340                    | -       | Liquid Chlorine              | 17,266.00            | -         | 100      | -       |
|                   |                           |         | Hydrochloric Acid            | 7,908.00             | -         |          |         |
|                   |                           |         | Hypochlorite                 | 637.00               | -         |          |         |
|                   |                           |         | 25,811.00                    |                      |           |          |         |
| CA-7              | 27,300                    | 26,868  |                              | 13,617.54            | 26,868    | 50       | 100     |
| CA-8<br>(3 units) | 34,886                    | 42,024  | Ethylene Dichloride          | 12,909.00            | 4,888.00  | 100      | 96      |
|                   |                           |         | Purge                        | 2,680.00             | 5,395.00  |          |         |
|                   |                           |         | Liquid Chlorine              | 19,297.00            | 29,888.00 |          |         |
|                   |                           |         | 34,886.00                    | 40,171.00            |           |          |         |

| Unit                | Chlorine Production (TPA) |           | Chlorine Segment   | Chlorine Utilisation |            |          |         |
|---------------------|---------------------------|-----------|--|----------------------|------------|----------|---------|
|                     | 1998-99                   | 2000-01   |  | Quantity (TPA)       |            | Per cent |         |
|                     |                           |           |  | 1998-99              | 2000-01    | 1998-99  | 2000-01 |
| CA-9                | 52,288                    | 50,390    | Trichloroethylene  | 6409.20              | -          | 99       | 99      |
|                     |                           |           | Hydrochloric Acid  | 28,935.96            | -          | -        | -       |
|                     |                           |           | Sodium Hypo  | 438.16               | -          | -        | -       |
|                     |                           |           | Chlorine To Chemplast  | 8,987.50             | -          | -        | -       |
|                     |                           |           | Chlorine To Spic Organics  | 1,620.40             | -          | -        | -       |
|                     |                           |           | Chlorine To Paper Industry   | 1,484.00             | 1,800.00   | -        | -       |
|                     |                           |           | Chlorine To Bleach Liquor  | 91.80                | -          | -        | -       |
|                     |                           |           | Chlorine To Wholesalers  | 2,557.41             | -          | -        | -       |
|                     |                           |           | Chlorine To Nuclear fuel complex   | 75.60                | -          | -        | -       |
|                     |                           |           | Chlorine To Wood pulp  | 361.80               | -          | -        | -       |
|                     |                           |           | Chlorine To Kothari Sugars   | 175.50               | -          | -        | -       |
|                     |                           |           | Chlorine To Water Treatment  | 189.75               | -          | -        | -       |
|                     |                           |           | Chlorine To KMML   | 102.60               | -          | -        | -       |
|                     |                           |           | Chlorine To Export   | 359.10               | -          | -        | -       |
|                     |                           |           | PVC Units  | -                    | 9,000.00   | -        | -       |
| Other Sectors       | -                         | 3,200.00  | -  | -                    |            |          |         |
| Captive Consumption | -                         | 36,000.00 | -  | -                    |            |          |         |
|                     |                           |           | 51,788.88  | 50,000.00            |            |          |         |
| CA-12               | 6,401                     | 8,056     |  | 5,806.982            | 7,250.00   | 91       | 90      |
| CA-13               | 1,15,911                  | 1,15,678  | Chlorosulphonic Acid CPW, Bleaching Powder, Benzyl Products, Aluminium Chloride                                      | 17,764.00            | 17,764.00  | 100      | 100     |
|                     |                           |           | CMC/MCA/ONCB/PNCB/MB Sodium Hypochlorite, Thionil Chloride, Bulk Drugs, Dyes, Pulp & Paper, Water Treatment & Others | 97,914.00            | 97,914.00  |          |         |
|                     |                           |           |  | 1,15,678.00          | 115,678.00 |          |         |
| CA-19               | 31,134                    | -         | Liquid Chlorine  | 19,406.00            | -          | 100      | -       |
|                     |                           |           | Hypochlorite   | 4,006.04             | -          | -        | -       |
|                     |                           |           | Hydrochloric Acid  | 6,452.00             | -          | -        | -       |
|                     |                           |           | Hypo Drained   | 982.708              | -          | -        | -       |
|                     |                           |           | Purged   | 288.00               | -          | -        | -       |
|                     |                           |           |  | 31,134.748           |            |          |         |
| CA-20               | 15,208                    | 26,947    | Hydrochloric Acid  | 1,290.59             | 2,000.00   | 100      | 89      |
|                     |                           |           | Sodium Hypochlorite  | 166.23               | 300.00     | -        | -       |
|                     |                           |           | Chloromethanes   | 300.00               | 500.00     | -        | -       |
|                     |                           |           | CPW  | 4,000.00             | 6,000.00   | -        | -       |
|                     |                           |           | Pesticides   | 1,500.00             | 2,500.00   | -        | -       |
|                     |                           |           | Chemicals And Pharmaceuticals  | 3000.00              | 4,500.00   | -        | -       |
|                     |                           |           | Dyes & Dyes Intermediates  | 2,300.00             | -          | -        | -       |
|                     |                           |           | MCA  | 2,500.00             | 4,000.00   | -        | -       |
|                     |                           |           | Others   | 150.80               | 4,000.00   | -        | -       |
|                     |                           |           |  | 300.00               |            |          |         |
|                     |                           |           | 15,207.62  | 24,100.00            |            |          |         |
| CA-22               | 12,077                    | 15,330    | Liquid Chlorine  | 8,947.78             | -          | 100      | 99      |
|                     |                           |           | Hydrochloric Acid  | 3,114.37             | -          | -        | -       |
|                     |                           |           | Paper  | -                    | 7,595.00   | -        | -       |
|                     |                           |           | CPW  | -                    | 2,404.00   | -        | -       |
|                     |                           |           | Captive Consumption  | -                    | 3,954.00   | -        | -       |
|                     |                           |           | Other Sector   | 1,297.00             | -          | -        |         |
|                     |                           |           |  | 12,062.15            | 15,250.00  |          |         |
| CA-24               | 41,121                    | 39,239    | CPW  | 12,514.89            | 10,707.00  | 96       | 94.76   |
|                     |                           |           | Paper & Pulp   | 5,346.86             | 3,802.00   | -        | -       |
|                     |                           |           | Pesticides   | 4,102.39             | 1,695.00   | -        | -       |
|                     |                           |           | Water Purification   | 362.86               | 347.00     | -        | -       |
|                     |                           |           | Fertiliser   | 435.49               | 30.00      | -        | -       |
|                     |                           |           | Chemicals  | 11,088.25            | 2,049.00   | -        | -       |
|                     |                           |           | HCl  | 5,735.03             | 5,136.00   | -        | -       |
|                     |                           |           | SBP  | -                    | 6,466.00   | -        | -       |
|                     |                           |           | Aluminium Chloride   | -                    | 6,449.00   | -        | -       |
|                     |                           |           |  |                      |            |          |         |
|                     |                           |           | 39,585.77  | 37,182.00            |            |          |         |
| CA-26               | 46,000                    | -         | HCl  | 16,100.00            | -          | 100      | -       |
|                     |                           |           | HYPHO  | 920.00               | -          | -        | -       |
|                     |                           |           | CHNP   | 16,100.00            | -          | -        | -       |
|                     |                           |           | Liquid Chlorine  | 12,880.00            | -          | -        | -       |
|                     |                           |           | 46,000.00  |                      |            |          |         |

| Unit                         | Chlorine Production (TPA) |         | Chlorine Segment              | Chlorine Utilisation |           |          |         |                   |            |
|------------------------------|---------------------------|---------|-------------------------------|----------------------|-----------|----------|---------|-------------------|------------|
|                              | 1998-99                   | 2000-01 |                               | Quantity (TPA)       |           | Per cent |         |                   |            |
|                              |                           |         |                               | 1998-99              | 2000-01   | 1998-99  | 2000-01 |                   |            |
| CA-27                        | 62,601                    | -       | Liquid Chlorine               | 50,403.00            | -         | 100      | -       |                   |            |
|                              |                           |         | Hydrochloric Acid             | 11,270.70            | -         |          |         |                   |            |
|                              |                           |         | Hypochlorite                  | 922.50               | -         |          |         |                   |            |
|                              |                           |         |                               | 62,596.20            | -         |          |         |                   |            |
| CA-29                        | 22,980                    | 21,888  | Liquid Chlorine               | 15,082.032           | 17,879.00 | 99.5     | 100     |                   |            |
|                              |                           |         | Hydrochloric Acid             | 7,777.943            | 3,794     |          |         |                   |            |
|                              |                           |         | Capative                      | 19.763               | -         |          |         |                   |            |
|                              |                           |         | Soda Hyp (Bleach Liquid)      |                      | 215.00    |          |         |                   |            |
|                              |                           |         |                               | 22,879.738           | 21,888    |          |         |                   |            |
| CA-32                        | 32,743                    | 41,258  | Paper                         | 2,453.00             | 2,950.00  | 100      | 96      |                   |            |
|                              |                           |         | Pesticides                    | 6,417.00             | 7,700.00  |          |         |                   |            |
|                              |                           |         | Hydrochloric Acid             | 6,422.00             | 7,700.00  |          |         |                   |            |
|                              |                           |         | Chemicals & Pharmaceuticals   | 12,357.00            | 15,000.00 |          |         |                   |            |
|                              |                           |         | Dyes & Dyes Intermediates     |                      |           |          |         |                   |            |
|                              |                           |         | Others                        | 1,691.00             | 2,000.00  |          |         |                   |            |
|                              |                           |         |                               | 3,403.00             | 4,100.00  |          |         |                   |            |
|                              |                           |         | 32,743.00                     | 39,450.00            |           |          |         |                   |            |
| CA-37                        | 56,685                    | 45,847  | Chemicals                     | 22,291.00            | 18,000.00 | 100      | 99      |                   |            |
|                              |                           |         | Hydrochloric Acid             | 13,600.00            | 11,000.00 |          |         |                   |            |
|                              |                           |         | Paper                         | 7,045.00             | 6,000.00  |          |         |                   |            |
|                              |                           |         | PVC                           | 3,675.00             | 2,000.00  |          |         |                   |            |
|                              |                           |         | Water Treatment               | 2,421.00             | 2,000.00  |          |         |                   |            |
|                              |                           |         | Drugs & Pharma                | 2,378.00             | 2,000.00  |          |         |                   |            |
|                              |                           |         | Textiles                      | 2,277.00             | 2,000.00  |          |         |                   |            |
|                              |                           |         | Fertilizers & Pesticides      | 1,046.00             | 1,000.00  |          |         |                   |            |
|                              |                           |         | Sodium Hypochlorite           | 760.00               | 700.00    |          |         |                   |            |
|                              |                           |         | Drugs & Intermediates         | 638.00               | 600.00    |          |         |                   |            |
|                              |                           |         | Power Projects & Atomic Power | 554.00               | 500.00    |          |         |                   |            |
|                              |                           |         |                               | 56,685.00            | 45,800.00 |          |         |                   |            |
|                              |                           |         | CA-38                         | 76,213               | -         |          |         | Hydrochloric Acid | 20,227.352 |
| Sodium Hypo                  | 1,266.34                  | -       |                               |                      |           |          |         |                   |            |
| Liquid Chlorine Sales        | 33,945.235                | -       |                               |                      |           |          |         |                   |            |
| Liquid Chlorine To M/S NOCIL | 20,774.273                | -       |                               |                      |           |          |         |                   |            |
|                              | 76,213.20                 |         |                               |                      |           |          |         |                   |            |
| CA-39                        | 12,187                    | -       | Liquid Chlorine               | 4,311.00             | -         | 98       | -       |                   |            |
|                              |                           |         | Hydrochloric Acid             | 6,730.00             | -         |          |         |                   |            |
|                              |                           |         | Bromine                       | 903.00               | -         |          |         |                   |            |
|                              |                           |         |                               | 11,944.00            | -         |          |         |                   |            |

Source : Alkali Manufacturer's Association of India, Annual Report 1998-99 and 2000-01

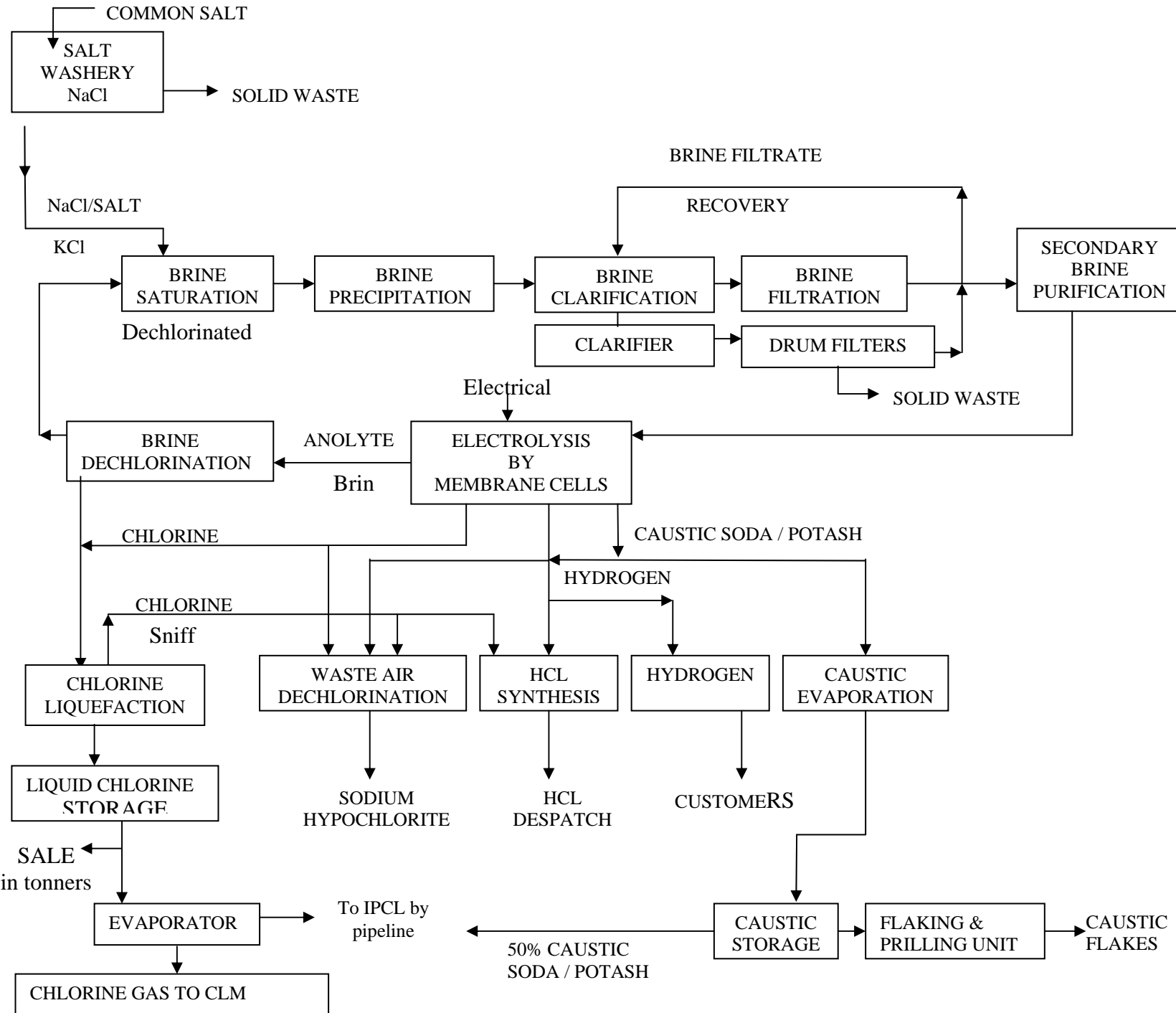

**Schematic Flow Diagram of Caustic Soda Production by Membrane Cell Process (Industrial Unit A)**



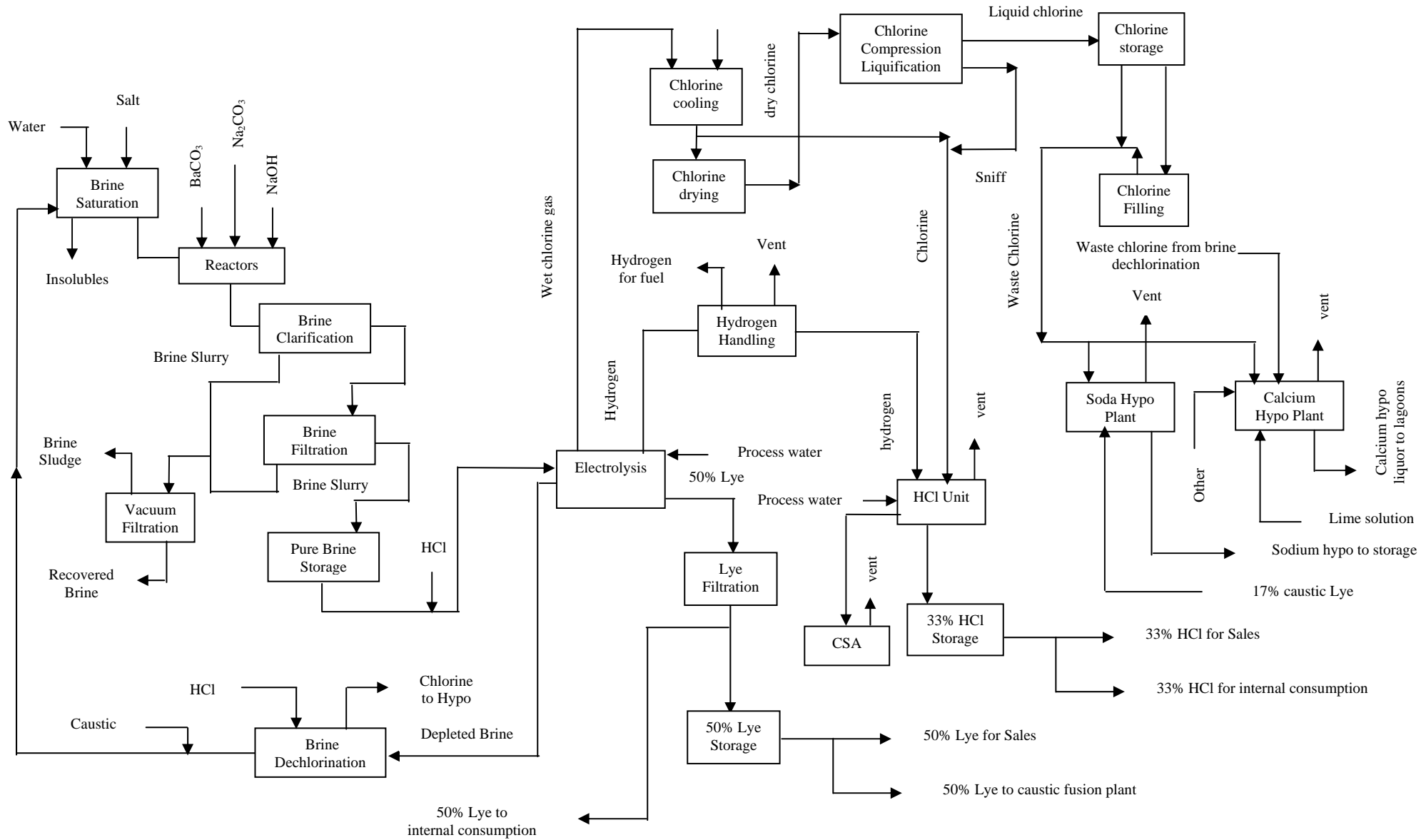

**Block Diagram of Caustic Soda Production (Mercury Cell Process) (Industrial Unit C)**

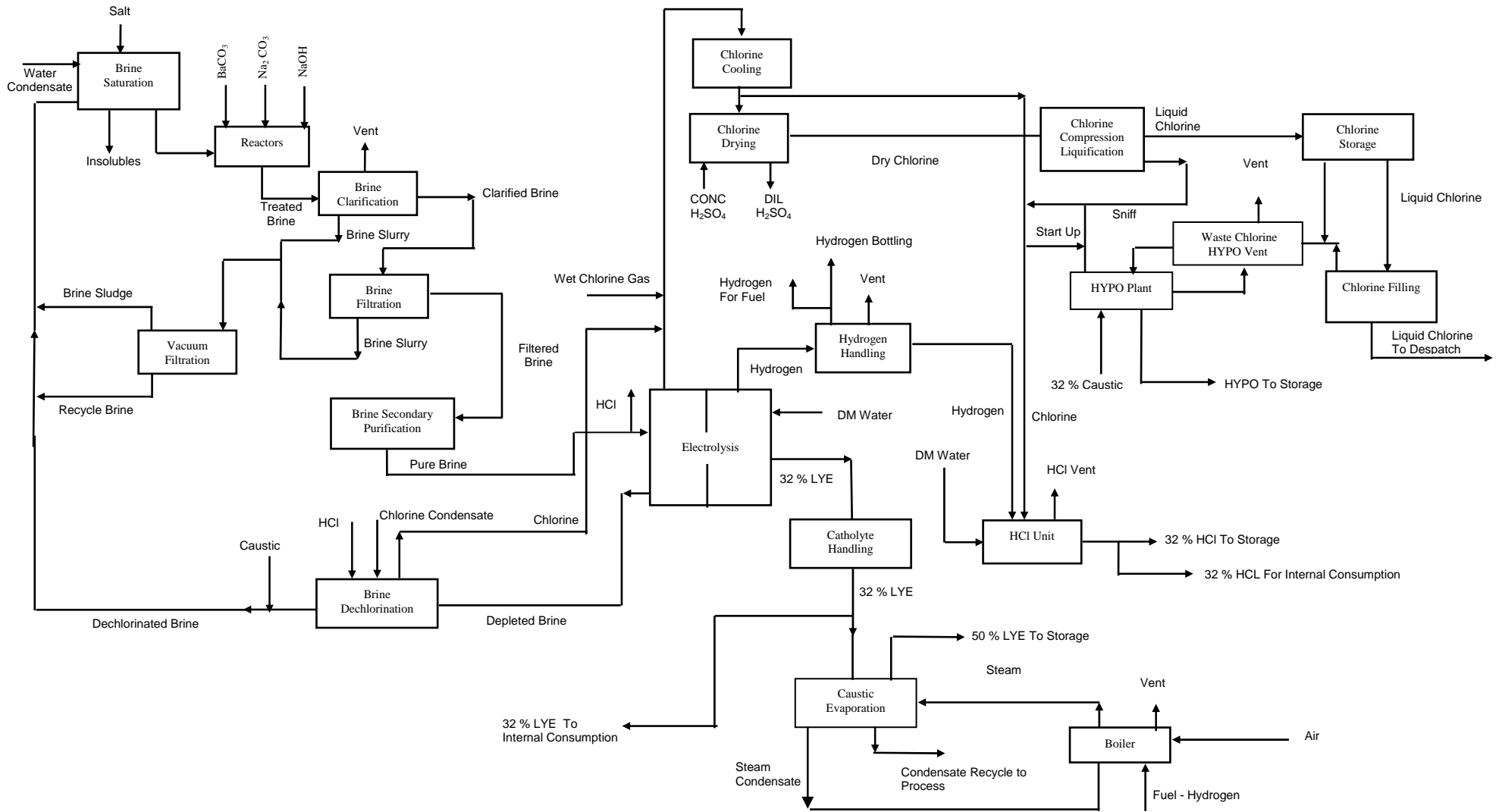

**Block Diagram of Caustic Soda Production (Membrane Process), (Industrial Unit D)**

## Chlorine Production, Utilisation and its Mass Balance

### Unit A

This industrial unit presently produces caustic soda, chlorine (liquid and gas), hydrogen, hydrochloric acid, sodium hypochlorite, hydrogen peroxide, caustic soda flakes, potassium hydroxide, potassium carbonate, sodium cyanide, sodium ferro-cyanide and mixed chloromethanes. It produces caustic soda using Ion-Exchange Membrane Process by Electrolytic Process of Sodium Chloride Brine. The production unit for caustic soda also produces chlorine and hydrogen as co-products.

### Process Description

The membrane cell process has the following sections:

- i. Primary Brine Plant
- ii. Secondary Brine Plant
- iii. Membrane Cell Plant
- iv. Chlorine / Hydrogen Treatment Plant
- v. HCl / Sodium Hypo Plants
- vi. Utilities Plant
- vii. Wastewater Treatment Plant.

**i. Primary Brine Plant:** Salt (Sodium Chloride) is dissolved in saturators into the return brine from cells. Sodium bisulphite is added to return brine for removal of traces of free chlorine. Common Salt is fed into the saturators through salt handling equipment like Pay Loaders, Belt Conveyors, and Elevators. The raw salt contains impurities like sulphates, calcium and magnesium. These impurities are removed by addition of chemicals like barium carbonate, soda ash or  $\text{Na}_2\text{CO}_3$  solution and 18% caustic soda lye. The impurities are precipitated. To coagulate these precipitates, flocculant like Magna floc is added in clarifier and clear brine is filtered using anthracite filters.

**ii. Secondary Brine Treatment:** The filtered brine is further purified in secondary pre-coat filters, where in alpha-cellulose is used as filter medium. The brine passes through a series of two ion-exchange columns to remove final traces of impurities and to make the brine ultra-pure (hardness level < 20 ppb) suitable for using in Ion-Exchange Membrane Cells Electrolysis Process. High purity brine is required in membrane cell process to increase the membrane life and to decrease power consumption.

**iii. Membrane Cell Plant:** The Membrane Cell Plant follows Ion-Exchange process for production of caustic soda. The electrolyte in the case of caustic soda is ultra-pure sodium chloride solution.

In membrane cell plant, there are 30 bi-polar cell racks each with 94 elements. Eight cells are connected to a rectifier in parallel circuit. The rectifiers are to convert AC to DC for electrolysis process. Any individual electrolyser can be cut-out while others are in operation.

The cell elements are the single vessel design. Specially coated titanium is used as anodes and specially coated nickel is used as cathodes. The ion-exchange membrane is clamped between the anodes and cathode pans are bolted together at the flange, constituting a cell element. The current is conducted from a cell to a cell in the electrolyser by means of contact strips.

All the elements in one electrolyser are suspended in a steel frame. For uniform current transmission the individual elements are grouped and pressed against the fixed contact points of the frame by means of thrust element.

The brine & the dilute catholyte are admitted at the bottom of the cell and anolyte & catholyte are discharged downwards. The feed piping and discharge piping are connected by means of long plastic hoses. This arrangement and other design measures prevent current leaks due to potential differences between the cells, which would have a detrimental effect. The flow rates of ultra-pure brine and caustic soda feeds to each electrolyser are adjusted and monitored by flow meters.

Nitrogen flushing facility is given to the hydrogen headers for flushing the headers prior to start up or after shutdown to remove the oxygen content. The anolyte returns by gravity flow to the anolyte tank through the anolyte header. For each individual cell element a separate outlet for chlorine gas and anolyte is provided. The catholyte runs by gravity via the hydrogen / catholyte separator into the catholyte tank.

The purity of chlorine gas in chlorine gas chamber is monitored continuously. The cells are operated at a chlorine pressure of 2000 mm WC. The pressure of hydrogen is maintained at 130 mm above the chlorine pressure.

**iv. Chlorine Plant:** Chlorine gas produced in membrane cells leaves the cells at 2000 mm WC at 90°C. The chlorine gas exchanges heat with polished brine in the chlorine recuperator and cooled to 50°C in the process. The polished brine gets heated to 55°C in the process. The chlorine condensate gets collected in a tank and pumped to anolyte tank. The chlorine gas is further cooled in Cl<sub>2</sub> coolers I & II for removal of moisture. The gas coming from the coolers gets dried in Cl<sub>2</sub> drying tower with sulphuric acid. The dried chlorine gas is compressed and liquified in a liquifier and a part of the chlorine gas is sent to Hydrochloric Acid Plant.

The liquid chlorine flows by gravity to storage tanks from where it goes to chlorine bottling plant for filling in chlorine tonner, pumped to chlorine evaporators for supply of evaporated chlorine to IPCL and chloromethane plant.

The uncondensed chlorine vapours (sniff gas) from the liquifiers flow to hydrochloric acid plant for production of hydrochloric acid.

**Hydrogen Plant:** The hydrogen gas produced in the membrane cells leaves at a pressure of 2300 mm WC at 90°C. It is cooled to 40°C in hydrogen recuperator for condensation of moisture. The cooled hydrogen gas goes to gasholder from where it is distributed to various consumption points.

**v. Hydrochloric Acid & Hypo Plants:** The chlorine and hydrogen gases are burnt in HCl Synthesis Units to produce HCl gas which is absorbed in demineralised water to produce 30% HCl. The acid is transferred to storage tank and despatched. At the time of any shutdown, Nitrogen gas is purged to the unit as a safety measure.

In the sodium hypo plant caustic (18%) is circulated in absorption towers. Vent gases from the plant are absorbed in this plant to produce sodium hypochlorite. These measures effectively control air pollution.

**vi. Utilities Section:** For the normal operation of the plant, various utilities are required, which are as follows:

- Process and Cooling Water
- Chilled Water
- Compressed Air
- Demineralised Water
- Steam
- Nitrogen

**Process and Cooling Water:** Process water is used for make up of water in cooling towers. Cooling water is used for cooling various streams in heat exchangers. Sodium Hexametaphosphate and biocides are added to maintain quality of water. Process water is received from power plant.

**Chilled Water:** Chilled water is used for cooling sulphuric acid in chlorine compressor coolers, hydrogen gas and chlorine gas. Freon-11 & Freon-12 are used as refrigerants in chilled water units.

**Compressed Air:** Compressed air is used for filling of chlorine in cylinders and for operation of control instruments in the plants. Process air is also used for pre-coating filters.

**Demineralised Water:** For use in membrane cell plants and hydrochloric acid units, demineralised water is produced using resins for selectively removing both cationic and anionic impurities and silica. Demineralised water is received from power plant.

**Steam:** Saturated steam is used for caustic evaporation unit, & flaking unit. Steam is supplied from power plant depending on requirement.

**Nitrogen:** Nitrogen gas is used for purging various gas lines during shutdown and start-up of the process.

**vii. Wastewater Treatment Plant:** To maintain effluent quality, effluents are segregated from contaminated and non-contaminated streams. Section-wise neutralisation pit for control of pH for different sections like caustic concentration, prilling / flaking, caustic & hydrochloric acid storage, potassium carbonate, chloromethanes and demineralised water plant are provided. After neutralisation, it is discharged to main effluent treatment plant where suspended solids are separated under gravity settling. An automatic pH control system along with recirculation line for recirculation to the pit and a sand filter for removal of suspended solids and final polishing are installed to ensure discharge of treated effluent.

#### **Possible Emission Sources in Chlor-alkali Plant**

- Depleted brine section
- Cell house
- Chlorine drying section
- Chlorine liquefaction section (sniff)
- Liquid chlorine pump
- Chlorine evaporator
- Chlorine storage tanks (sniff)
- Chlorine cylinder filling
- Chlorine treatment section (DC tower)
- Hydrochloric acid plant
- Hypo vent stack

## Chlorine Emissions and their Control Measures

**i) Waste Air Dechlorination System / Sodium Hypochlorite Plant :** Chlorine bearing waste gases from various sections of the plant are processed in the waste air dechlorination unit. The gas is scrubbed with NaOH (18%) and unabsorbed gas is vent into atmosphere. Chlorine reacts with caustic soda to form sodium hypochlorite. The scrubbing is carried out in two rubber lined towers in series for absorption of chlorine and bleach liquor (sodium hypochlorite solution) is kept in circulation through pump and a cooler to remove the heat generated due to above reaction. Both the absorption towers are in operation continuously and level of first tower is maintained by constant overflow to second tower, whereas level of second tower is maintained by a level controller. The bleach liquor contains 50-60 g/L of available chlorine and is stored in a storage tank. The residual gases from sodium hypo section are vented into atmosphere.

All the equipment is connected to emergency power back up system to take care of power failure and tripping. Caustic lye (18%) storage tank is kept at a height and arrangements are made by installation of level controllers so that it remains full at all the times.

Thus, the waste chlorine gas from the caustic soda and chlorine plant is treated with dilute caustic soda in the chlorine absorption plant.

The salient features of the waste chlorine absorption system are as under :

- Two staged packed columns are provided in series at sodium hypochlorite plant. Bulk of the chlorine absorption takes place in the first column itself and the balance in the second tower
- The system is designed to handle an emergency chlorine release corresponding the full production of the plant for 10 minutes
- The composition of the scrubbing medium is continuously monitored and controlled by an on-line redox analyser with an alarm in the control room
- An adequate buffer stock of NaOH (18%) is maintained in a head tank and in the event of an emergency the system is flooded with NaOH (18%) by the opening of an automatic on-off valve. A facility to manually open this valve is also provided
- Adequate temperature monitors and alarms are provided in the system
- All drives on this limit, viz. the blowers and circulating pumps are connected to emergency power and are on auto-start ensuring that this unit is in operation all the time
- A chlorine detector is located at the exit point of the scrubbed gas to the atmosphere.

**ii) HCl Emissions from HCl Synthesis Unit :** In HCl synthesis unit, hydrogen and chlorine are fired together at controlled conditions generating hydrochloric acid fumes, which are absorbed in DM water and results in hydrochloric acid (30%). The gas stream after absorption is led to water scrubber where the traces of hydrochloric acid fumes are absorbed by a packed column absorption tower using DM water as absorbing media. After recovery of HCl, tail gases are passed through water scrubber to absorb the traces of HCl in water.

Chlorine monitoring sensors are provided at storage tank, chlorine bottling area, liquid chlorine pump, chlorine evaporator, hypo-section towards Ranoli village, towards Sarabhai Machinery and vent hypo stack. The sensors detect chlorine as low as one part per million. Audio-visual alarm with continuous recording has been provided in the control room to take immediate corrective action. Prevailing wind direction is also continuously monitored and recorded in the control room.

## Handling of Emergency Chlorine Gas Leakages

**Cell House and Chlorine Plant:** The Central Control room is equipped with Distributed Control System (DCS) providing good number of process interlocks for plant, personnel and environmental safety. In case of emergency, the interlocks trip the plant to safe position.

In case of emergency, if chlorine gas pressure is reached to very high, the rectifier will trip on interlock and chlorine gas pressure will be released to the waste air dechlorination unit automatically. In the event of plant stoppage / start up or during operation chlorine is sucked through waste air blower and diverted to waste chlorine absorption system. The unabsorbed gases are vented to atmosphere. Caustic circulation pump and waste chlorine blowers are connected to automatic emergency back up power system.

**Chlorine Storage and Filling Station:** Each chlorine storage tank is equipped with the following:

- Magnetic flow type level indicator with audio-visual alarm system in the control room
- Two pressure gauges with audio-visual alarm system in the control room
- A pair of rupture discs and safety valves is connected to a continuously operated waste air dechlorination (absorption) system.

All the interconnected pipelines of the tanks have two consecutive bellow seal type valves. The first is the operating valve and the second is an emergency shut off valve. One of the tanks is always kept empty to take care of emergency, if any.

The chlorine containers received from consumers are thoroughly cleaned, filled and loaded in the vehicles with all safety precautions. Special type of valves (bellow seal) is provided to minimise fugitive emissions in chlorine filling section. Seamless and stress relieved copper tubes are used for filling the chlorine containers.

**Power Backup Facilities :** M/s GACL has adequate supply of power required for plant operation through Gujarat Electricity Board (GEB), Nandesari & Jawaharnagar Sub-station. All the moving machines of the plant have emergency power backup facility in addition to normal power supply from GEB, Jawaharnagar and Nandesari Sub-station. In case of power failure from Nandesari, the unit will run on Jawaharnagar power supply and in case of Jawaharnagar grid failure, supply from Nandesari grid is provided. In case of both the grids trip, power supply is continued through Diesel Generator (DG) set (capacity : 625 kVA) as an alternate power backup facility. In the event of tripping due to power failure, traces of waste chlorine generated from the process and chlorine-bottling section is absorbed and neutralised in waste air dechlorination system. The absorption system is connected to cell houses, HCl tanks and chlorine systems. Audio-visual alarm with continuous recording has been provided in the control room to take immediate corrective action.

Number of interlocks is provided at electrolyzers and other plant sections. Most of the interlocks are connected with the rectifier as the process is highly power intensive and tripping of rectifier will immediately stop generation of hazardous gases.

## Estimated chlorine losses in HCl production from HCl synthesis unit (1999-2000)

Quantity of chlorine equivalent lost: 3.56 kg/MT of HCl (30%) production  
Total quantity of chlorine eq. lost in 59130 MT HCl production  
= production (MT) x 0.00356  
= 59130 x 0.00356

|                                 |   |          |
|---------------------------------|---|----------|
|                                 | = | 210.5 MT |
| Chlorine loss in HCl production | = | 210.5 MT |

### Estimated chlorine losses in HCl production from HCl synthesis unit (2000-2001)

|   |                                    |
|---|------------------------------------|
| Quantity of chlorine equivalent lost:                                 | 3.53 kg/MT of HCl (30%) production |
| Total quantity of chlorine equivalent lost in 52431 MT HCl production |                                    |
|   | = Production (MT) x 0.00353        |
|   | = 52431 x 0.00353                  |
|   | = 185.08 MT                        |
| Chlorine loss in HCl production                                       | = 185.08 MT                        |

## Chlorine Production, Utilisation and its Mass Balance

### Unit B

This industrial unit presently produces Caustic soda, Chlorine, Hydrogen gas, Hydrochloric acid, Sodium Hypochlorite, Stable Bleaching Powder (SBP), Poly Aluminium Chloride (PAC), PVC, Urea, Calcium carbide, Cement. They produce SBP and PAC since 1999 for captive consumption of chlorine and HCl respectively. The Unit has captive power plant. The chlor-alkali plant of the Unit produces caustic soda based on mercury cell process by electrolysis of salt (NaCl). During electrolysis, chlorine and hydrogen gases are also produced.

**The Mercury Cell Process:** The brine is prepared by dissolution of salt with depleted brine at 60 to 70°C. The salt used for electrolysis contains undesirable impurities like Calcium, Magnesium & Sulphate, which are removed by the addition of Sodium Carbonate, Sodium hydroxide & Barium Carbonate in the brine respectively in reaction tanks. The reacted material is sent to Clarifier to settle down the precipitates. Overflow of clear brine from Clarifier tank flows to Clarified Brine Tank, then sent to polished brine tank via Sand filters. The filtrate is the purified brine whose pH is adjusted to about 5.0 with HCl. The brine from Polished brine tank is fed to electrolyzers to produce Caustic soda lye, Chlorine & Hydrogen gas.

One tonne 100% pure caustic soda utilises about 1.6 tonnes of NaCl in brine preparation. It mainly depends on the impurity in the salt. The concentration of the brine is between 300 to 310 g/L. This saturated brine is sent to Cell House (mercury cell) for electrolytic dissolution, where only 35 to 40 g/L NaCl is electrolysed and the balance is returned for resaturation after dechlorination. The depleted brine contains about 270 g/L NaCl. In mercury cell the electrolysis takes place at around 3.7 volts. The highly reactive sodium (Na<sup>+</sup>) discharges at the cathode, which form sodium-mercury amalgam. It flows out to secondary cell / denuder along with demineralised water. Water and sodium amalgam form sodium hydroxide (caustic soda) and mercury is set free, which is recirculated.

The NaOH of 47.5 % concentration is sent to storage to be sold as lye. Part quantity is concentrated to flakes (Dehydrated NaOH) and packed in 50 Kg bags for sale. Caustic soda lye is also used as a one of the raw material for PAC & sodium hypochlorite.

The chlorine gas produced in cell is washed, cooled, and further dried in drying tower where Sulphuric Acid is sprayed as a drying agent. The dry chlorine gas passes through filters and liquified in the liquefier after compression. In liquefier freon is used as a refrigerant. Thus, liquid chlorine is formed. About 92 % of the chlorine gas sent to the refrigeration section is liquefied and the rest 8 % of the sniff chlorine gas is utilized by mixing with the fresh chlorine for burning in the HCl synthesis unit with hydrogen gas to produce hydrochloric acid. The unutilised gas goes to Hypo Plant, where it is allowed to absorb with caustic soda solution in absorbers, which finally forms sodium hypochlorite, which is sold in the market



**HCl Synthesis Unit:** The chlorine gas from cell house is passed through scrubber to remove NaCl mist from chlorine gas, which is burned with part of hydrogen from cell house followed by Demercurisation unit and Flame arrester in HCl Unit. This burned mixture of gas is cooled through cooling pipe and absorber to produce 30% HCl for storage. In case of tripping of HCl unit Chlorine gas is automatically diverted to neutralising system based on lime and sodium Hydroxide. This HCl is utilised for inhouse consumption in PVC plant and poly aluminium chloride (PAC) and for internal consumption such as brine preparation, D.M.Water plant etc.

**Chlorine liquefaction:** The balance chlorine from electrolyzers i.e. Chlorine: 3511 kg/hr and H<sub>2</sub>O: 545 kg/hr is passed through water scrubber to remove heat and brine mist and the condensate 525 kg/hr is returned to brine tank. After scrubber, the chlorine is further cooled by using cooling water and sent to drying tower to remove moisture by using 98% sulphuric acid as dehydrating agent. The dry chlorine is compressed and passed through a demister and then liquefied in liquefier using freon as refrigerant. Liquefied chlorine gas is stored in storage tanks and then bottled in containers of 900 kg capacity. All the above figures represent Chlorine liquefaction at 75 TPD. However, Chlorine plant load varies according to the requirements of PVC plant.

During liquefaction, about 386 kg/hr sniff Chlorine is generated in liquefier. This sniff Chlorine is burned with hydrogen in HCl unit to produce 30% HCl. Also 200 kg/day sniff chlorine from liquid chlorine storage tank and 100 kg/day sniff chlorine from cylinder filling is sniffed out, which is neutralised by caustic soda to produce sodium hypochlorite (1066 kg/day) as per the market demand so that any loss of chlorine can be recovered. This sodium hypochlorite is sent to the storage tank. Alternatively, the sniff chlorine is treated with Calcium Hydroxide to form bleach liquor, which is disposed into lagoon. The solid waste (Calcium hypochlorite) from lagoon is utilised to produce cement in their complex.

**Sodium Hypochlorite Plant:** The chlorine from bottling sniff, tank sniff and HCl Units (during start up or tripping) is passed through wash tower followed by hypo towers I & II and through circulation tanks I, II & III to produce sodium hypochlorite -solution.

**Hydrogen Compression & Bottling:** Hydrogen gas from cell house / electrolyser is cooled by water, scrubber and demercurised by chilling and passed through specially treated activated carbon bed. The treated hydrogen is sent to HCl synthesis unit for production of hydrochloric acid. The part of hydrogen gas is compressed and sold as compressed hydrogen.

## Chlorine Utilisation

**Stable Bleaching Powder:** The liquid chlorine from chlorine section is utilised to produce stable bleaching powder. About 0.47 T/T of chlorine is utilised to produce stable bleaching powder. The stable bleaching powder is manufactured by chlorination of Hydrated Lime in a Semi-Batch process. Hydrated lime is charged into a jacketed chlorination drum, liquid chlorine is also fed into drum. The reaction is under vacuum of about 50 mmHg and heat of reaction is removed by cooling water to maintain temperature of 45-50°C. After chlorination, product is dried under vacuum by heating with steam, the dried material is then cooled by cooling water to 40°C and transferred to product hopper. The powder is packed from the product hopper in HDPE bags. Any unreacted chlorine gas is absorbed in two stage scrubbers in caustic soda solution so that the chlorine emission can be avoided.

In packing and storage a small quantity of stable bleaching powder is lost. However, it is collected by sucker and recycled and packed. So that the losses of final product are recovered.

**Poly Aluminium Chloride (PAC):** PAC 18%, PAC 14% and PAC 10% is produced as per the market demand. The PAC is value added chemical and consumes caustic soda and HCl (30%) produced from Kota complex. PAC is utilised as coagulant in water and wastewater treatment.

Poly Aluminium Chloride (18%) is obtained by high temperature and high pressure reaction between Hydrochloric Acid (30%) and Alumina (hydrated). Glass Lined Reactor is charged with HCl (30%) at room temperature followed by Alumina charging. After all Alumina is loaded, reactor is closed and steam is applied to start the reaction, which is exothermic in nature. Steam is supplied for heating the slurry up to 160 °C. Once desired temperature is achieved, and the same will be maintained for 4 - 6 hours. PAC is then cooled to a temperature of 100 °C & then discharged into intermediate storage tank through heat exchanger. PAC, which is in liquid form, is passed through filter press to remove unreacted Alumina. Clear liquid from filter press outlet is collected in storage tank.

PAC 10% Production is obtained by reaction between Aluminium Chloride, Alum , Sodium Aluminate & Sodium Silicate. This reaction is run in special conditions to prevent formation of water insoluble Alumina Hydroxide gel. The plant is controlled by automation. Hence, the possibility of any leakage is ruled out.

**PVC:** The PVC manufacturing technology is based on Calcium Carbide (CaC<sub>2</sub>) route, which is unique in India. The SFC has installed this plant to utilise the HCl produced from their chlor-alkali plant.

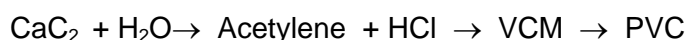

The acetylene required for VCM monomer is manufactured by burning CaC<sub>2</sub>, which is produced by lime stone in SFC complex. In PVC manufacturing, acetylene and HCl (30%) from chlor-alkali plant is mixed to produce VCM monomer. The plant is very clean and controlled by automation. The VCM monitors are located to control the VCM emissions. The final product obtained is in the form of powder PVC.

**Handling of emergency due to chlorine gas leakages:** The dilute Chlorine from cell house and chlorine from dechlorination tower is neutralised by lime, which is sent to D.C. tower to form bleach liquor of lime. Part of this bleach liquor is sent to acetylene plant and lagoon. The solid waste (calcium hypo) is utilised for production of cement in their complex. This D.C. tower filled with lime is also utilised during emergency to control the leakages (accidental). The leak chlorine from all sections of the plant is scrubbed in packed towers with alkaline solution to produce sodium hypochlorite. This plant has a facility of gravity flow of Caustic in the towers in case of total black out.

The chlorine monitors are installed in and around Cell house, Hypo plant, HCl, cylinder filling & storage of chlorine and SBP plant. Monitors are also installed around complex boundary including carbide and PVC plants.

After chlorine leakage detection by monitor, the source of leakage will be isolated, residual chlorine gas is removed under vacuum and then converted to Hypo. In the event of power failure, chlorine will be diverted to Hypo plant.

For operating the various plants, power from two sources is available Viz.,

- Own generation ( captive generation of 85 MW)
- Power from state electricity board.

Power from above sources is handled independently. Plants are normally operated on own generation, which is very reliable. In case of power failure all critical equipments have back up, auto-change over arrangements to the other source of power. Thus, Chlorine losses due to power failure are ruled out.

About control of leakages during chlorine manufacturing process all the electrolyzers are under vacuum, thus possibilities of chlorine leakage in cell house is ruled out. In case of any variation in process chlorine is diverted to neutralisation section. The plant has standby neutralisation facilities and thereby chlorine leakage is remotely possible.

Burning sniff chlorine with hydrogen to produce HCl utilizes sniff chlorine gas (unliquefiable gas) and part of sniff is treated with lime to produce bleach liquor. Hence, possibilities of leakages are very remote.

As chlorine pipes are of PVC/FRP, Valves are of Titanium/Rubber lined, Blower etc. are made of titanium with Mechanical seal thus, chlorine leakages from pump glands, flange joints, corroded pipes, fittings and valves are remotely possible.

### **Chlorine Production, Utilisation and its Mass Balance**

#### **Unit C**

This industrial unit presently produces caustic soda, chlorine, hydrogen, hydrochloric acid, sodium hypochlorite, sulphuric acid, single superphosphate, chloro-sulphonic acid and caustic potash. The caustic soda is manufactured by the electrolysis of saturated solution of sodium chloride (brine) in mercury cells. During electrolysis, chlorine and hydrogen gases are produced.

**The Mercury Cell Process:** Common salt (sodium chloride) is dissolved with water in saturators and the impurities, viz. calcium, magnesium and sulphate which are picked up during brine saturation are removed in reactors by the addition of sodium carbonate, sodium hydroxide and barium carbonate respectively. The treated brine is clarified, filtered and pumped to constant level tank for supply to electrolytic cells after acidifying to pH 2.0 - 2.5. The electrolytic cell consists of two parts, viz. Primary cell and Decomposer. Pure brine is fed to the primary cell through a rotameter. When direct current is passed from anode to cathode through brine solution, electrolysis of brine takes place and Na<sup>+</sup> ions form an amalgam with the flowing mercury, which acts as cathode and chlorine is liberated at the anode and drawn by the suction of chlorine compressor.

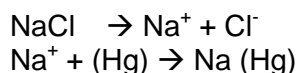

The amalgam (sodium + mercury) is allowed to flow into decomposer. Process water continuously fed into decomposer reacts with amalgam to form sodium hydroxide and hydrogen gas. The mercury from the decomposer is recycled to the primary cell.



The 48-50% caustic soda lye, which is produced in decomposer overflows into process tanks, is cooled and pumped to main storage tanks after filtration. Hydrogen gas is drawn under pressure by the blowers.

The returned depleted brine from the electrolytic cells contains dissolved chlorine, hypochlorous acid etc. The chlorine from depleted brine is recovered by adding HCl acid to

maintain pH 2 - 2.5 and dechlorinating by air stripping in dechlorination tower. The acidic brine after neutralising with caustic is saturated, treated, clarified, filtered and recycled to the process.

The brine sludge generated from brine treatment (clarifier etc.) is pumped to vacuum filter. The filtrate coming is stored in a tank and recirculated to the brine system while the sludge cakes are conveyed to lagoons for disposal.

Chlorine and hydrogen gases are used for preparation of liquid chlorine and hydrochloric acid and the surplus hydrogen gas is used as a fuel in caustic soda flaking plant.

**Chlorine Liquefaction:** Chlorine gas leaves the electrolytic cell at 70°C saturated with water vapour. It is first cooled in a primary cooler to condense water vapour. A part of the wet chlorine gas is delivered to hydrochloric acid synthesis units after passing through washing tower to remove salt mist and further allowed to pass through a special mist eliminator, where salt and entrained particles are removed.

The remaining portion of the wet chlorine flows to the secondary cooler having chilled water as cooling medium. The chlorine is sub-cooled to condense water vapour in order to minimise the sulphuric acid consumption for chlorine drying. The gas is then dried with direct contact of circulating sulphuric acid in three packed towers operating in series. The dry chlorine gas after passing through a mist eliminator is compressed up to 2.5 kgs/cm<sup>2</sup> by acid ring rotary compressor and fed into liquefactors.

Chlorine gas is cooled in liquefactor upto - 20°C under deep refrigeration system by Freon compressors. The gas gets condensed and forms as liquid chlorine and stored in tanks. The unliquefied chlorine gas sniffed off under pressure control system. The sniff chlorine gas is consumed in the manufacture of hydrochloric acid or sodium hypochlorite.

From the storage tank the liquid chlorine is withdrawn for cylinder filling by means of dry compressed air padding to 10 kgs/cm<sup>2</sup>. The waste chlorine from storage tank and cylinder filling section is sent to neutralising system i.e. calcium hypochlorite or sodium hypochlorite system.

**Hydrochloric Acid Plant:** The hydrogen gas from electrolysis room, after cooling with chilled water is delivered by a blower to hydrochloric acid synthesis plant and caustic fusion plant. The HCl synthesis unit consists of a burner, falling film absorption column, tails tower and a final packed scrubber.

In both the hydrogen and the chlorine lines are provided automatic block valves interlocked with the furnace photoelectric cell. In case of flame failure, the two valves are automatically closed, while a third automatic block valve will allow an inert gas (N<sub>2</sub> gas) to enter the furnace to purge the system.

Chlorine gas and hydrogen gas at a flow ratio of 1 : 1.1 (to ensure complete burning of chlorine gas) are fed to the combustion chamber (burner) after establishing flame inside and allowed to burn to form HCl gas.

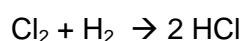

The hydrogen chloride gas is absorbed in process water by feeding water to tails tower, which overflows to the cooler-absorber forming 32-33% HCl and flows by gravity into the Mild Steel Rubber Lined (MSRL) storage tanks. The exhaust gases from the tails tower are let out after passing through a packed scrubber, where water is circulated to absorb traces of HCl.

**Sodium Hypochlorite Plant :** The waste chlorine from storage and chlorine filling section are fed to the hypo towers containing 18% caustic lye. Chlorine reacts with caustic soda solution to form sodium hypochlorite, which is sent to storage tanks and sold as bleach lye.

**Chlorine Absorption Plant :** Waste gases from various sections of the plant are diverted to chlorine absorption plant, where chlorine is absorbed in lime under circulation in absorption towers. There are two batches of absorption tower containing three towers in each batch, one batch in operation and the other one in cleaning and maintenance process. The towers are provided with baffle plates to have more contact area between waste gases and lime solution. The exhaust gases from towers are vented out through a chimney 60 m in height.

The lime under circulation is analysed hourly. When concentration of  $\text{Ca(OH)}_2$  drops to 20 g/L, the lime slurry is discharged to lagoons for solar evaporation and fresh lime of 110-120 g/L is charged to the system.

**Caustic Soda Flakes (Fusion) Plant :** The caustic lye (50%) is pumped to the single effect evaporator through a pre-heater. An additive solution prepared by dissolving the sugar in caustic lye is dosed into the feed caustic lye in order to destroy the oxidising agents like chlorates and dissolved air in the feed lye so that the corrosion attack of the evaporator equipment is minimised.

The evaporation takes place under vacuum. The water vapours are condensed by means of barometric condenser. The steam ejector or vacuum pump provides the vacuum to the system.

The caustic liquor (70-73%) from bottom of caustic separator is pumped to the anhydrous caustic concentrators system operating two numbers in parallel. The caustic (73%) in anhydrous caustic evaporators is heated counter-currently with inorganic molten salt, which in turn is heated in a vertical furnace with fuel oil or hydrogen gas. The caustic (73%) is in anhydrous molten state by the time it passes through the long tube (evaporators) concentrators.

The molten caustic and the super heated vapours are separated in a separator. The water vapours are cooled and condensed in a barometric condenser operating the system under vacuum. The molten caustic (99%) from the separator is collected into anhydrous caustic storage tank and overflows into flaker pan to produce flakes or filled directly into drums. The flakes are directly filled in HDPE bags lined with alkathene liners and weighed.

**Chloro Sulphonic Acid (CSA) :** Hydrogen chloride and sulphur trioxides are the raw materials required for chloro sulphonic acid preparation. Hydrogen chloride gas generated in synthesis unit of caustic soda plant is drawn to the reactor, wherein chloro sulphonic acid is in circulation. The HCl gas meets sulphur trioxide gas generated in oleum evaporator to form chloro sulphonic acid.

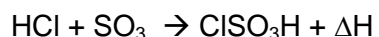

The heat generated in the system is removed in a cooler and product CSA is drawn to storage tanks.

## **Chlorine Emissions & their Control Measures**

**1. Chlorine emissions through  $\text{Cl}_2$  stack:** The following are the sources of waste chlorine emissions in the caustic soda and chlorine liquefaction plants :

- i. Return brine dechlorination
- ii. Chlorine filling section
- iii. Cells cut-in and cut-outs
- iv. Power failures

The waste chlorine gas from the above sources is absorbed in caustic soda to produce sodium hypochlorite in the sodium hypochlorite plant or the waste chlorine gas can also be absorbed in lime slurry at calcium absorption plant.

The waste chlorine gas is absorbed in the dilute caustic soda solution of about 17-18% concentration to produce 8.5% sodium hypochlorite solution. The heat of dilution and heat of reaction is removed by passing the solutions through chilled water coolers. The waste chlorine gas is effectively utilised to produce sodium hypochlorite solution and the chlorine removal efficiency is more than 99% in the residual gases.



In the calcium absorption plant, slaked lime is prepared in batch mode and is used to absorb the waste chlorine gas.

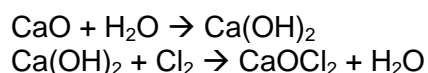

There are six numbers of lime absorption towers with RCC construction and are assembled in segments. Each segment has a baffle, which covers half the diameter of the tower to provide better area of contact between the lime solution and waste chlorine gas. The lime slurry is kept in continuous circulation and the pumps are connected to the emergency power supply in order to operate them even at the power failure periods.

The residual waste chlorine gases after absorption are let out to the atmosphere through an FRP chimney of 400 mm in diameter and 60 m in height, which is well supported with an FRP lined steel structure and a heavy concrete foundation. The  $\text{Ca(OH)}_2$  content of the lime slurry is estimated at every hour and when the  $\text{Ca(OH)}_2$  content of the lime slurry drops to 20-30 g/L, fresh lime slurry is put into circulation and the spent slurry is discharged into specially constructed alkathene lined lagoons.

Thus, the waste chlorine emissions from the caustic soda and chlorine plants are treated with lime slurry in the lime absorption plant.

**Handling of Chlorine Gas Leakages:** The chlorine monitors are installed in and around cell house, liquid chlorine storage, cylinder filling, hypo plant and HCl acid plant. Monitors are also installed around the factory premises. After chlorine leakage detection by monitor (3 ppm and above), the source of leakage is isolated and in turn connected to chlorine absorption unit i.e. chlorine neutralization system.

In the events of power failure and cell cut-in and cut-outs, chlorine is diverted to neutralization system. Dissolved chlorine in return brine is degasified and absorbed in lime solution under circulation. During cut-in and cut-out of cells, chlorine gas is sent to absorption unit until the normalcy in cell condition is achieved. During power failure, chlorine gas immediately after starting the plant is absorbed in lime until the normalcy in operating conditions are achieved.

Burnt lime with CaO (70-85%) is used for absorbing waste chlorine from cells during shutdown, return brine section and during cut-out and cut-in of cells. Waste chlorine is absorbed in lime solution under circulation and the exhausted slurry (calcium hypo) is

drained into lagoons where water is evaporated by solar evaporation. The dried solid waste is disposed in low-lying areas of the industry complex as landfill material once in three years. A part of the waste chlorine gas is used for sodium hypo preparation.

The residual gases from absorption towers are vent to atmosphere through a 60 m in height FRP chimney.

**Power Backup Facilities :** Three numbers of emergency diesel generators are provided with a total capacity of 556 KVA as alternate power supply during the power failures. Apart from this, one number of 1000 KVA and 4 numbers of 2270 KVA each diesel generators as an alternate power resource is provided. All the blowers and circulation pumps in the plant are connected to the emergency power and are in operation all the time. The dilute chlorine gas from the process operations is diverted to the lime absorption unit, which is also connected to emergency power during the power failure. Automatic controls are also provided for switch over of supply from normal to emergency.

**2. HCl emissions from HCl Plant :** The other source of chlorine emission is unabsorbed HCl gases in the hydrochloric acid production.

The unabsorbed gases from the graphite chambers and mild steel chambers of the HCl plant are scrubbed with water to remove the unabsorbed HCl from the gases. All the graphite and mild steel chambers are provided with individual unabsorbed HCl gas scrubbers of PVC-FRP make and with 300 mm in diameter and 15 m in height each for the scrubbing of unabsorbed HCl gases.

These unabsorbed gases are taken from the vent gas scrubbers through the separate blowers and absorbed with water in the respective scrubbers. The unabsorbed HCl gets dissolved in water and results in the reduction of the scrubber water pH 3.5 to 4.0. This scrubber water is taken to the final effluent treatment plant, where it is mixed with alkaline effluents from caustic soda plant.

Thus, the waste chlorine gas carried along with the unabsorbed HCl gas from the HCl plant are effectively removed by treating with water in the scrubbers.

**3. HCl emissions from CSA Plant :** In chloro sulphonic acid (CSA) manufacture, the unreacted HCl gas is a source of chlorine emission. The unreacted HCl gas is taken to a tail gas scrubber from the top of the CSA reactor, where it is absorbed in water. The unreacted HCl gas gets dissolved in water and results in the reduction of scrubber water pH 3.5 to 4.0. This scrubber water is taken to the final effluent treatment plant, where it is mixed with alkaline effluents from caustic soda plant.

Thus, the waste chlorine gases carried along with the unreacted HCl gas from CSA plant are effectively removed by treating with water in the tail gas scrubber.

### **Estimated Chlorine Losses in terms of HCl from HCl Synthesis and CSA Units : HCl Synthesis Unit**

|  |                                    |
|--|------------------------------------|
| Quantity of HCl lost                                     | : 18 kg/MT of HCl (33%) production |
| Total quantity of HCl lost in 23703.44 MT HCl production |                                    |
|  | = production (MT) x 0.018 MT       |
|  | = 23703.44 x 0.018                 |
|  | = 426.66 MT                        |
| Chlorine lost in terms of HCl                            | = 426.66 x 0.328                   |
|  | = 139.94 MT                        |
| Chlorine loss in HCl production                          | = 140 MT                           |

## Chloro Sulphonic Acid (CSA) Unit

|  |   |                              |
|--|---|------------------------------|
| Quantity of HCl lost in CSA production                 | : | 19 kg / MT of CSA            |
| Total quantity of HCl lost in 6978.4 MT CSA production |   |                              |
|  | = | production (MT) x 0.019 (MT) |
|  | = | 6978.4 x 0.019               |
|  | = | 132.58 MT                    |
| Chlorine lost in terms of HCl                          | = | 132.58 x 0.310               |
|  | = | 41.10 MT                     |
| Chlorine lost in CSA production                        | = | 41.10 MT                     |

Total quantity of chlorine lost in HCl & CSA production = 140 + 41.10 = 181.10 MT

## Chlorine Production, Utilisation and its Mass Balance

### Unit D

This industrial unit presently produces caustic soda, chlorine, hydrogen gas, hydrochloric acid and sodium hypochlorite. They also produce calcium hypochlorite from waste chlorine, which is disposed of as a solid waste.

The chlo-alkali plant of ASL, Saggonda produces caustic soda based on membrane cell technology by electrolysis of salt (NaCl). During electrolysis, chlorine and hydrogen gases are also produced.

### **The Membrane Cell Process :**

**Brine System:** The brine is prepared by dissolution of NaCl (common salt). The concentration of brine is between 300 and 310 g/L. The brine fed into the electrolyzers is an aqueous solution. The brine feed rate is held at a value proportional to the rated capacity of electrolyzers to ensure that the brine leaving the electrolyser will contain approximately 200-230 g/L NaCl.

**Brine dechlorination:** The outgoing depleted brine from the electrolyzers, saturated with chlorine, is sent to the chlorate decomposer (dechlorination chamber) where concentrated hydrochloric acid is added to the brine for decomposing the excess gas of chlorates in order to maintain them at an acceptable value for the membranes of the cell, then it is dechlorinated by vacuum dechlorination with a steam ejector. The return brine is treated with sodium sulfite solution to remove the traces of chlorine. The chlorine gas is recovered in the main chlorine header.

**Brine Saturation, Settling and Filtration:** After excess acid is neutralised, the dechlorinated brine is admitted to the re-saturation step. The saturated brine around 300 g/L NaCl flows to the reactor (mechanically agitated), where it is mixed with chemicals to precipitate the impurities. The impurities usually present in raw brine are magnesium, calcium, sulphate and a small quantity of iron.

Caustic soda is used for precipitating magnesium as magnesium hydroxide, barium carbonate for precipitating sulphate as barium sulphates and sodium carbonate is used for the calcium precipitation as calcium carbonate. The brine from the reactor flows by gravity to a settler and pumped through a filter to a receiver.

**Brine Secondary Purification and Cell Feeding:** After controlling brine temperature, the filtered brine undergoes the purification process suitable to reduce the Calcium and



Magnesium hardness to a few parts per billion levels, as required by the membrane cells process.

High purification levels are reached by ion-exchange treatment in columns (2 Nos.) packed with chelating resins having high selectivity towards the metal ion impurities of the brine. The operating sequence of the two columns is automatically controlled by a programmer / controller. The purified brine flows to the cells after heat exchange with chlorine coming from electrolyser.

**Sludge Filtration:** The sludges coming from brine treatment are collected in a receiver and sent to a sludge filter. The filtrate is recovered in a tank and recirculated to the brine system while the sludge cakes are conveyed to containers for disposal.

The caustic soda solution (32% concentration) from the electrolyzers is collected in a receiver located near the electrolysis room. The NaOH (32% concentration) is sent to evaporation unit where it gets concentrated from 32 to 48%. Caustic soda lye is also used as one of the raw materials for sodium hypochlorite.

## Chlorine

**Chlorine cooling and blowing:** Chlorine gas produced in the electrolyzers, saturated with water vapour flows to the titanium shell and tube heat exchanger to exchange heat with pure brine. Thereafter, chlorine flows to first cooler where most of its water vapour is condensed. Part of the wet chlorine gas is blown to the HCl synthesis unit after passing through a special mist eliminator, which removes salt and entrained particles.

Part of wet chlorine flows to the second shell and tube titanium cooler having chilled water as cooling medium. The chlorine is sub-cooled in cooler where most of its water vapour is condensed in order to minimise the sulphuric acid consumption for chlorine drying. Chlorine saturated with condensed water is sent to brine before dechlorination.

**Chlorine drying:** Sub-cooled chlorine flows to the first drying tower where it is dried by direct washing with sulphuric acid. A centrifugal pump re-circulates the acid through the tower while a fraction of acid overflows continuously to the dilute acid tank. Dilute acid is stripped with air to remove dissolved chlorine and is pumped to storage tanks.

The concentration of overflowing dilute sulphuric acid is kept around 80%, which is a tolerable limit for the piping material, and the cooler provided for the system. A similar acid circulation takes place in the second drying tower. The acid overflows from second tower to the first drying tower at a concentration of about 93%, while fresh acid at 96-98% concentration is fed continuously into the third drying tower from the concentrated acid head tank. Coolers are provided to remove absorption and dilution heat from the sulphuric acid solution. Cooling medium for these sulphuric acid coolers is chilled water depending on actual plant characteristics.

**Chlorine Compression:** Dry chlorine gas is compressed with sulphuric acid liquid ring compressor at 3.5 ATA and delivered to the low-pressure liquefaction unit.

**Chlorine liquefaction, storage and filling :** The compressed gas is condensed by a freon system. Freon vapours coming from the freon evaporator (chlorine liquefier) are sucked by the freon compressor where they are compressed up to condensing conditions and delivered to the condenser. In the condenser, freon is cooled by water passing in the tubes side and is liquefied, collected at the bottom of the condenser.

Before reaching the evaporator liquid, freon is sub-cooled in a freon heat exchanger (or in an economizer) by freon vapours coming from the evaporator.

The freon in the evaporator is completely vaporised in the tubes side liquefying chlorine which flows in the shell side or vice-versa. Condensed chlorine flows by gravity to liquid chlorine storage tanks. The composition of gases, which are not condensed (sniff gas) is controlled in order to keep the hydrogen content within safe limits. This sniff gas is delivered to the hypochlorite and HCl units.

From the storage tanks, the liquid chlorine is sent to filling with dry compressed air.

**Hydrogen :** The hydrogen coming from the electrolysis room header or cell house flows to a shell and tube heat exchanger where the gas is cooled and most of the water vapour is condensed. Cooled hydrogen is passed through a mist eliminator, which removes entrained particles and flows to a gasholder from where a part of hydrogen is blown to the HCl synthesis unit. The part of hydrogen gas is compressed and sold as compressed hydrogen.

**HCl Synthesis Unit:** The HCl synthesis unit consists of three principal parts, viz. the burner, the synthesis chamber-heat exchanger assembly and the receptor.

- a. The burner consists of two silica tubes mounted inside a graphilor housing for their easy replacement. The burner has two inlets, one for chlorine and the other for hydrogen
- b. The synthesis chamber-heat exchanger assembly consists of a combustion chamber provided with two tubes, which permit the automatic control of the flame and to ignite the furnace. The unit synthesis-absorption type includes a distribution element with an inlet for the absorber. The heat exchanger (at the lower part) consists of columns of absorbing blocks. The heat exchanger includes a column of cooler blocks
- c. The receptor is a graphilor element for the separation of the acid product from the vent gases. At the bottom of this element there is a graphilor safety disc and below this an explosion guard.

Blowers deliver the hydrogen coming from electrolysis room, after cooling, to the furnace burner. The chlorine is directly fed to the furnace burner by the chlorine blowing system. A pressure control valve automatically controls the chlorine pressure.

The hydrogen and chlorine lines are foreseen automatic block valves interlocked with the furnace photoelectric cell. In case of flame failure, the two valves are automatically closed, while a third automatic block valve will allow an inert gas to enter the furnace to purge the system.

The hydrochloric acid gas produced in the synthesis furnace is first cooled and absorbed in water in a cooler-absorber. Absorption water before entering the cooler-absorber is used to wash the tail gases in a washing tower. Suction is provided through the system by tails exhaust fans. The hydrochloric acid solution (30-33% strength) is collected in a receiver and stored in storage tanks.

**Sodium hypochlorite unit :** The plant is operated as a batch operation to obtain a product of constant strength and also takes care of the concentration of chlorine and its quantity in the absorption process.

The absorption system consists essentially of reaction towers, two circulation tanks and a set of centrifugal pumps for recirculating absorption solution through the reaction tower. Vent and sniff chlorine gases from various plant sections are fed to the bottom of the reaction tower, while dilute caustic soda enters at the top of the tower and is recirculated till

the required concentration is obtained to produce hypochlorite solution. The hypochlorite solution is recovered in the storage tanks and marketed as bleach Lye.

### **Chlorine Emissions and their Control Measures**

**i) Chlorine Emission through Chlorine Stack :** Chlorine bearing waste gases from various sections of the plant are processed in the waste air dechlorination unit. The gas is scrubbed with NaOH (18%) and vent into atmosphere. The scrubbing is carried out in three packed columns connected in series. NaOH (18%) is fed to the last column and travels counter current to the gas stream. Chlorine reacts with caustic soda to form sodium hypochlorite, which is sold as bleach lye. The heat of absorption of chlorine is removed by circulating the scrubbing liquid through coolers. The residual gases from soda hypo section are diverted to calcium hypo section for further absorption of chlorine before being vented to atmosphere.

In the calcium hypo section, slaked lime is prepared in batch mode and is used to absorb the waste chlorine gas. The lime slurry is kept in continuous circulation through the absorption towers where the waste chlorine gas is in contact with lime slurry in counter-current fashion. The circulation pumps and waste chlorine blowers are connected to the emergency power supply in order to operate at the power failure duration.

Thus, the waste chlorine gas from the caustic soda and chlorine plants are treated with dilute caustic soda or lime slurry in the chlorine absorption plant.

The salient features of the waste chlorine absorption system are as under :

- Two staged packed columns are provided in series at sodium hypochlorite plant. Bulk of the chlorine absorption takes place in the first column itself and the balance in the second tower. The third column acts as a polishing tower
- The system is designed to handle an emergency chlorine release corresponding the full production of the plant for 10 minutes
- Adequate system hold up is provided to prevent the temperature from rising above 38°C in the event of a cooling water failure
- The composition of the scrubbing medium is continuously monitored and controlled by an on-line redox analyser with an alarm in the control room
- An adequate buffer stock of NaOH (18%) is maintained in a head tank and in the event of an emergency the system is flooded with NaOH (18%) by the opening of an automatic on-off valve. A facility to manually open this valve is also provided
- Adequate temperature monitors and alarms are provided in the system
- All drives on this limit, viz. the blowers and circulating pumps are connected to emergency power and are on auto-start ensuring that this unit is in operation all the time
- A chlorine detector is located at the exit point of the scrubbed gas to the atmosphere.

**ii) HCl Emissions from HCl Synthesis Unit:** HCl is synthesised by burning hydrogen and chlorine. An excess of hydrogen over the stoichiometric requirement is used to ensure that there is no unreacted chlorine. This is achieved by means of a ratio controller. The HCl gas produced in the furnace is absorbed in water. The unabsorbed HCl gas from the absorber is scrubbed with water in a packed column. The dilute acid from the scrubber is monitored and in the event of a low flow, the unit is shut down safely. The HCl content in the gas leaving the scrubber is maximum 10 mg/Nm<sup>3</sup>.

The residual gases after absorption in absorber and tail gas tower is diverted to waste HCl absorber and again scrubbed with demineralised water. The resultant dilute hydrochloric acid is utilised in hydrochloric acid production by mixing with feed water.

Handling of Emergency Chlorine Gas Leakages: The Central Control Room is equipped with 'Distributed Control Systems' (DCS) providing good number of process interlocks for plant, personnel and environmental safety. In case of power interruptions, emergency power generators (1 x 308 KVA) are installed with auto start facility to supply emergency power within few seconds for important plant operations, controls and utilities. Apart from this two numbers each of 1000 KVA and 3.8 MW captive diesel generators are available as an alternate power backup facility. Additionally the Central Control Room is provided with uninterrupted power supply for controls. Number of interlocks is provided at electrolyzers and other plant sections. Most of the interlocks are connected with the rectifier as the process is highly power intensive and tripping of rectifier will immediately stop generation of hazardous gases.

The chlorine monitors are installed in and around cell house, liquid chlorine storage, cylinder filling and hypo plant. Some of the monitors are connected to the DCS room for continuous monitoring of chlorine leakages.

In the event of power failure and cell cut-in and cut-outs, chlorine is diverted to waste chlorine absorption system.

In case of any emergency tripping in any plant section, to avoid consequential damage in other sections and to stop accidental releases, the emergency trip system is utilised. Sudden tripping of rectifier will divert all the plant sections handling chlorine to hypo section for neutralisation with caustic / milk of lime. This will avoid accidental releases of gas in plant section and to the atmosphere. Sudden tripping of rectifier will also trip hydrogen blower in hydrogen handling section to avoid sucking of air into hydrogen, which leads to explosion. The interlocks are also installed at chlorine, HCl plants and are described as under:

- Sudden tripping of chlorine compressor reduced rectifier load by 25% to avoid release of chlorine gas at Cell House and chlorine drying system
- Sudden tripping of Freon compressors also trips the chlorine compressor to avoid release of excess chlorine gas at hypo section
- High pressure at liquefier will automatically be released to hypo section for safety reasons
- At hydrochloric acid plant, flame detection by photocell arrangements is provided to avoid explosion. Flame failure will be detected and the photocell activates the shut off valves of chlorine and hydrogen. The purge nitrogen will be opened into the hydrogen system automatically

### **Estimated Chlorine Losses in terms of HCl from HCl Synthesis Unit**

Quantity of HCl lost : 18 kg/MT of HCl (33%) production

Total quantity of HCl lost in 28760.7 MT HCl production

|                                 |   |                            |
|---------------------------------|---|----------------------------|
|                                 | = | production (MT) x 0.018 MT |
|                                 | = | 28760.7 x 0.018            |
|                                 | = | 517.69 MT                  |
| Chlorine lost in terms of HCl   | = | 517.69 x 0.322             |
|                                 | = | 166.7 MT                   |
| Chlorine loss in HCl production | = | 166.7 MT                   |

### Mass Balance of Chlorine Production and Utilization (1999 - 2000)

#### Unit A

| Sl. No.       | Description                | Production (MT) | Chlorine Consumption Norm (MT/MT) | Actual Chlorine Consumption Norm (MT/MT) | Chlorine Consumed (MT) | Caustic Soda Production (MT) | Caustic Potash Production (MT) | Chlorine Production = Caustic soda production x 0.886 (MT) | Chlorine Production = Caustic potash production x 0.632 (MT) | Total Chlorine Production (MT) | Difference between Production & Consumption (MT) | Loss of Chlorine in HCl Production (MT) | Total Chlorine Loss (MT) |
|---------------|----------------------------|-----------------|-----------------------------------|--|------------------------|------------------------------|--------------------------------|--|--|--------------------------------|--|---|--------------------------|
|               | (1)                        | (2)             | (3)                               | (4)                                      | (5=2x4)                | (6)                          | (7)                            | (8=6x0.886)  | (9=7x0.632)  | (10=8+9)                       | (11=10-5)  | (12)                                    | (13)                     |
| A             | Liquid Chlorine            | 104396.274      | 1.0                               | 1.0                                      | 104396.274             | 129130                       | 14175                          | 114409.18  | 8958.6   | 123367.78                      | 12.196***  | 210.5++                                 | 222.696                  |
| B             | HCl (30%)                  | 59130           | 0.314                             | 0.314                                    | 18566.82*              |                              |                                |  |  |                                |  |   |                          |
| C             | Chloromethanes (CLM)       | 23490           | 1.830                             | 1.829                                    | 42963.21*              |                              |                                |  |  |                                |  |   |                          |
| D             | Sodium Hypochlorite (8.5%) | 4410            | 0.089                             | 0.089                                    | 392.49+                |                              |                                |  |  |                                |  |   |                          |
| Total (A+B+D) |                            |                 |                                   |  | 123355.524             |                              |                                |  |  |                                |  |   |                          |

\* Including sniff chlorine from liquefaction, storage section and chlorine cylinder filling. Excluding chlorine emission / discharge at 3.56 kg/MT of HCl (30%) production (tail gas scrubber).

\*\* Excluding HCl & CLM losses from chloromethane plant

\*\*\* The difference between production and consumption of chlorine is waste chlorine from the plant contributes to air vent from Chlor-alkali unit.

+ In caustic absorption system at sodium hypo plant the efficiency is 99.5%

++ The quantity 210.5 MT is the chlorine equivalent loss in HCl (30%) production in Chlor-alkali plant. This quantity is excluded in difference between production and consumption of chlorine.

**Mass Balance of Chlorine Production and Utilization ( 1999-2000)**

**Unit B**

| Sl. No.              | Product                                | Production (MT) | Chlorine Consumption Norms (MT/MT) | Chlorine Consumed (MT) | Caustic Soda Production (MT) | Chlorine Production= Caustic soda Production x 0.886 (MT) | Difference between Production & Consumption (MT) | Chlorine Recovered (MT) | Loss of Chlorine (MT) |
|----------------------|--|-----------------|------------------------------------|------------------------|------------------------------|---|--|-------------------------|-----------------------|
|                      | (1)                                    |                 |                                    |                        |                              |   |  |                         |                       |
| <b>1</b>             | <b>Liquid Chlorine*</b>                | 12324.0         | 1.08                               | <b>13309.92</b>        | 38750.0                      | 34332.5   | 253***   | 109.5****               | 143.5                 |
| <b>1.1</b>           | <b>Stable Bleaching powder</b>         | 2589            | 0.47                               | 1216.83                |                              |   |  |                         |                       |
| <b>2</b>             | <b>HCl (30 %)</b>                      | 68934           | 0.3                                | <b>20680</b>           |                              |   |  |                         |                       |
| <b>2.1</b>           | <b>HCl (30 %)- Despatched</b>          | 68685           | 0.3                                | <b>20606</b>           |                              |   |  |                         |                       |
| <b>2.1.1</b>         | <b>- Internal consumption</b>          |                 |                                    |                        |                              |   |  |                         |                       |
| 2.1.1.1              | - For PVC Plant                        | 62009.2         | 0.3                                | 18602.76               |                              |   |  |                         |                       |
| 2.1.1.2              | - For DM Plant                         | 1802.8          | 0.3                                | 540.84                 |                              |   |  |                         |                       |
| 2.1.1.3              | - For Brine Purification               | 2335.5          | 0.3                                | 700.65                 |                              |   |  |                         |                       |
|                      | <b>Sub total -Internal Consumption</b> |                 |                                    | 19844.25               |                              |   |  |                         |                       |
| <b>2.1.2</b>         | <b>- PAC Plant</b>                     |                 |                                    |                        |                              |   |  |                         |                       |
| 2.1.2.1              | - P.A.C.-18 %                          | 423.49          | 0.236                              | 99.94                  |                              |   |  |                         |                       |
| 2.1.2.2              | - P.A.C.-14%                           | 201.8           | 0.107                              | 21.59                  |                              |   |  |                         |                       |
| 2.1.2.3              | - P.A.C.-10 %                          | 368.42          | 0.117                              | 43.11                  |                              |   |  |                         |                       |
|                      | <b>Sub total -P.A.C. **</b>            |                 |                                    | 164.64                 |                              |   |  |                         |                       |
| <b>2.1.3</b>         | <b>External Sale-HCl 30 %</b>          | 1989.0          | 0.3                                | 596.7                  |                              |   |  |                         |                       |
| <b>2.2</b>           | <b>In stock</b>                        | 248.3           | 0.3                                | 74.5                   |                              |   |  |                         |                       |
| <b>3</b>             | <b>Chlorine utilised for HCl 30 %</b>  |                 |                                    | <b>20680</b>           |                              |   |  |                         |                       |
| <b>4</b>             | <b>Sodium Hypochlorite</b>             | 896             | 0.1                                | <b>89.6</b>            |                              |   |  |                         |                       |
| <b>TOTAL (1+3+4)</b> |  |                 |                                    | <b>34079.5</b>         |                              |   |  |                         |                       |

\* : Liquid chlorine is produced at 92 % liquefaction efficiency. Sniff generated is utilised for production of HCl- 30 % and Calcium hypochlorite

\*\* : Chlorine utilised for PAC production is a part of total HCl 30 % produced.

\*\*\* : 253 MT of chlorine is neutralised by calcium hydroxide (Lime ) to produce Calcium hypochlorite for use in purification of acetylene & subsequently used as raw material in cement plant.

In chlorine liquefaction section about 300 kg/day sniff chlorine is generated from liquid chlorine storage and chlorine cylinder section.

The sniff chlorine is neutralised with lime. Assuming, 300 kg/day sniff chlorine from Chlorine liquefaction = 300 x 365 = 109500 kg/year = 109.5 MT/year

\*\*\*\* :

**Mass Balance of Chlorine Production and Utilization (April 2000 - March 2001)**

**Unit C**

| Sl. No.      | Product                     | Production (MT) | Chlorine Consumption Norm (MT/MT) | Actual Chlorine Consumption Norm (MT/MT) | Chlorine Consumed (MT) | Caustic Soda Production (MT) | Caustic Potash Production (MT) | Chlorine Production = Caustic soda production x 0.886 (MT) | Chlorine Production = Caustic potash production x 0.633 (MT) | Total Chlorine Production (MT) | Difference between Production & Consumption (MT) | Loss of Chlorine in HCl & CSA Production (MT) | Total Chlorine Loss (MT) |
|--------------|-----------------------------|-----------------|-----------------------------------|--|------------------------|------------------------------|--------------------------------|--|--|--------------------------------|--|---|--------------------------|
|              | (1)                         | (2)             | (3)                               | (4)                                      | (5=2x4)                | (6)                          | (7)                            | (8=6x0.886)  | (9=7x0.633)  | (10=8+9)                       | (11=10-5)  | (12)  | (13)                     |
| 1            | Liquid Chlorine             | 20737           | 1.0                               | 1.0                                      | 20737*                 | 31474.216                    | 5533.666                       | 27886.155  | 3502.88  | 31389                          | 685.01****                                       | 181.10++                                      | 685.01                   |
| 2            | HCl (33%)                   | 23703.44        | 0.328                             | 0.322                                    | 7632.50**              |                              |                                |  |  |                                |  |   |                          |
| 3            | Chloro Sulphonic acid (CSA) | 6978.4          | 0.310                             | 0.304                                    | 2121.4***              |                              |                                |  |  |                                |  |   |                          |
| 4            | Sodium Hypochlorite (8.5%)  | 2521.86         | 0.085                             | 0.0845                                   | 213.09+                |                              |                                |  |  |                                |  |   |                          |
| <b>Total</b> |                             |                 |                                   |  | 30703.99               |                              |                                |  |  |                                |  |   |                          |

\* Excluding sniff chlorine from liquefaction and storage section

\*\* Excluding chlorine emission / discharge at 5.9 kg/MT of HCl production. Sniff from liquefaction and storage section is utilised in HCl production

\*\*\* Excluding HCl losses from absorption system

\*\*\*\* The difference between production and consumption of chlorine is waste chlorine from the plant contributes to the formation of solid waste and air vent from HCl synthesis and CSA unit. The waste chlorine gas from other section excluding air vent is absorbed in lime solution and calcium hypo is drained into the lagoon from absorption plant and water is evaporated by solar evaporation

+ In caustic absorption system at sodium hypo plant the efficiency is 99.5%

++ The quantity 181.10 MT is the chlorine lost during production of HCl (33%) and CSA. This quantity is included in difference between production and consumption.

### Mass Balance of Chlorine Production and Utilization (April 2000 - March 2001)

#### Unit D

| Sl. No. | Product                   | Production (MT) | Chlorine Consumption Norm (MT/MT) | Actual Chlorine Consumption Norm (MT/MT) | Chlorine Consumed (MT) | Caustic Soda Production (MT) | Total Chlorine Production = Caustic soda production x 0.886 (MT) | Difference between Production & Consumption (MT) | Loss of Chlorine in HCl Production (MT) | Total Chlorine Loss (MT) |
|---------|---------------------------|-----------------|-----------------------------------|--|------------------------|------------------------------|--|--|---|--------------------------|
|         | (1)                       | (2)             | (3)                               | (4)                                      | (5)=2x4                | (6)                          | (7=6x0.886)  | (8=7-5)  | (9)                                     | (10)                     |
| 1       | Liquid Chlorine           | 16420           | 1.0                               | 1.0                                      | 16420*                 | 29458.472                    | 26100  | 429.93***  | 166.7++                                 | 429.93                   |
| 2       | HCl (33%)                 | 28760.7         | 0.322                             | 0.316                                    | 9088.38**              |                              |  |  |   |                          |
| 4       | Sodium Hypochlorite (13%) | 1248.6          | 0.130                             | 0.1295                                   | 161.69+                |                              |  |  |   |                          |
| Total   |                           |                 |                                   |  | 25670.07               |                              |  |  |   |                          |

\* Excluding sniff chlorine from liquefaction and storage section

\*\* Excluding chlorine emission / discharge at 5.79 kg/MT of HCl production. Sniff from liquefaction and storage section is utilised in HCl production

\*\*\* The difference between production and consumption of chlorine is waste chlorine from the plant contributes to the formation of solid waste and air vent from HCl synthesis unit. The waste chlorine gas from other section excluding air vent is absorbed in lime solution and calcium hypo is drained into the lagoon from absorption plant and water is evaporated by solar evaporation.

+ In caustic absorption system at sodium hypo plant the efficiency is 99.5%

++ The quantity 166.7 MT is the chlorine lost during production of HCl (33%). This quantity is included in difference between production and consumption.



## Production and Utilisation of Chlorine (1999-2000)

## Unit A

| Sl. No. | Description                    | Consumption Norm (MT/MT)      | Production (MT) |
|---------|--------------------------------|-------------------------------|-----------------|
|         | <b>Production</b>              |                               |                 |
| 1.      | Caustic soda (NaOH)            | -                             | 129130          |
| 2.      | Potassium hydroxide (KOH)      | -                             | 14175           |
| 3.      | Chlorine gas                   | -                             | 123367.78       |
| 4.      | Liquid Chlorine                | 1.0                           | 104396.274      |
| 5.      | HCl (30%)                      | 0.314                         | 59130           |
| 6.      | Sodium Hypochlorite (NaOCl)    | 0.089                         | 4410            |
| 7.      | Mixed Chloromethanes           | 1.829                         | 23490           |
|         | <b>Utilisation</b>             | Chlorine gas utilisation (MT) |                 |
| 1.      | HCl production (30%)           | <b>18579.545</b>              |                 |
| 2.      | Sodium hypochlorite            | <b>391.961</b>                |                 |
| 3.      | Liquid Chlorine liquefaction   |                               |                 |
|         | Chloromethane (CLM) production | 42986.274                     |                 |
|         | IPCL                           | <b>31200.000</b>              |                 |
|         | Sales / tonners                | <b>30210.000</b>              |                 |
|         | <b>Total</b>                   | <b>123367.780</b>             |                 |

## Production and Utilisation of Chlorine (1999-2000)

## Unit B

| Sl. No. | Product                    | Consumption Norm (MT/MT) | Production (MT) |
|---------|----------------------------|--------------------------|-----------------|
| 1.      | <b>Caustic soda</b>        | -                        | 38,750          |
| 2.      | Liquid Chlorine            | 1.08                     | 12,324          |
| 3.      | HCl (30%)                  | 0.30                     | 68,685 *        |
| 4.      | Stable Bleaching Powder    | 0.470                    | 2,589           |
| 5.      | PAC 10%                    | 0.117                    | 368             |
| 6.      | PAC 14%                    | 0.107                    | 202             |
| 7.      | PAC 18%                    | 0.236                    | 423             |
| 8.      | Sodium Hypo chlorite (10%) | 0.10                     | 896             |

**Note :** Total Chlorine Production = 38,750 x 0.886 = 34,332.5 MT

\*: HCL 30 % as Dispatched

### Production and Utilisation of Chlorine (2000-2001)

#### Unit C

| Sl. No.            | Product                     | Consumption Norm (MT/MT) | Production (MT) |
|--------------------|-----------------------------|--------------------------|-----------------|
| <b>Production</b>  |                             |                          |                 |
| 1.                 | Caustic soda (NaOH)         | -                        | 31474.216       |
| 2.                 | Caustic potash (KOH)        | -                        | 5533.66         |
| 3.                 | Chlorine                    | -                        | 31389           |
| <b>Utilisation</b> |                             |                          |                 |
| 4.                 | Liquid Chlorine             | 1.0                      | 20737           |
| 5.                 | HCl (33%)                   | 0.328                    | 23703.442       |
| 6.                 | Chloro Sulphonic Acid (CSA) | 0.310                    | 6978.441        |
| 7.                 | Sodium Hypochlorite (8.5%)  | 0.085                    | 2521.86         |

**Quantity of Chlorine and its compounds lost during manufacturing per tonne of product :**

Liquid : Liquid Chlorine - Nil  
Sodium Hypo - Nil

|                                      |                          |                                 |
|--------------------------------------|--------------------------|---------------------------------|
|                                      | <u>Product lost / MT</u> | <u>Chlorine lost / MT</u>       |
| Gaseous : a) Hydrochloric Acid (33%) | 18 kg/Ton of HCl 33%     | 6 kg of chlorine/Ton of HCl 33% |
| b) Chloro Sulphonic Acid             | 19 kg/Ton of CSA         | 6 kg of chlorine/Ton of CSA     |

### Production and Utilisation of Chlorine (2000-2001)

#### Unit D

| Sl. No.            | Product                   | Consumption Norm (MT/MT) | Production (MT) |
|--------------------|---------------------------|--------------------------|-----------------|
| <b>Production</b>  |                           |                          |                 |
| 1.                 | Caustic soda (NaOH)       | -                        | 29458.472       |
| 2.                 | Chlorine                  | -                        | 26100           |
| <b>Utilisation</b> |                           |                          |                 |
| 3.                 | Liquid Chlorine           | 1.0                      | 16420           |
| 4.                 | HCl (33%)                 | 0.322                    | 28760.7         |
| 5.                 | Sodium Hypochlorite (13%) | 0.13                     | 1248.6          |

**Quantity of Chlorine and its compounds lost during manufacturing per tonne of product :**

Liquid : Liquid Chlorine - Nil  
Sodium Hypo - Nil

|                                      |                          |                                 |
|--------------------------------------|--------------------------|---------------------------------|
|                                      | <u>Product lost / MT</u> | <u>Chlorine lost / MT</u>       |
| Gaseous : a) Hydrochloric Acid (33%) | 18 kg/Ton of HCl 33%     | 6 kg of chlorine/Ton of HCl 33% |

## Annexure 2.6

## Estimated Major Contribution of Chlorine Losses

## Unit A

| Sl. No. | Emission / discharge sources                               | Contribution from sources / MT of Chlorine Production |  | Chlorine losses (MT/year) |           |
|---------|--|---|--|---------------------------|-----------|
|         |  | 1999-2000   | 2000-2001  | 1999-2000                 | 2000-2001 |
| 1       | Cell house*  | 1.0 ppm   | 1.0 ppm  | 0.012                     | 0.012     |
| 2       | Depleted brine**   | 9.72 kg   | 9.72 kg  | 1199                      | 1212      |
| 3       | Chlorine liquefaction section (Sniff)***                   | 83.69 kg  | 84.81 kg   | 10324.88                  | 10592.63  |
| 4       | Chlorine from Drying Section+                              | 8.49 gm   | 8.49 gm  | 1.047                     | 1.059     |
| 5       | Chlorine storage tanks (Sniff)****                         | 8.46 kg   | 8.57 kg  | 1043.7                    | 1069.3    |
| 6       | Chlorine cylinder filling (Sniff)****                      | 10.0 kg/MT of Cl <sub>2</sub> filling in tonners      | 10.0 kg/MT of Cl <sub>2</sub> filling in tonners | 302.1                     | 321.13    |
| 7       | Waste air Dechlorination system (Caustic Lye as solvent)++ | 3.181 kg  | 3.94 kg  | 392.43                    | 492.16    |
| 8       | HCl synthesis unit - tail gas scrubber+                    | 3.56 kg/MT of HCl production                          | 3.53 kg/MT of HCl production                     | 210.5                     | 185.08    |
| 9       | Sodium hypo vent+  | 3.52 kg/MT of hypo production                         | 3.47 kg/MT of hypo production                    | 15.52                     | 12.19     |

\* Negligible quantity

\*\* The chlorine discharge from depleted brine is recovered by HCl treatment during recycling

\*\*\* Sniff chlorine utilised in HCl production (Considering 91.5% liquefaction efficiency)

\*\*\*\* Sniff chlorine utilised in HCl production

+ Vent out to atmosphere

++ Recovered as sodium hypochlorite

## Estimated Major Contributions of Chlorine Losses

## Unit B

| Emission / discharge sources  | Contribution from sources | Chlorine losses (MT/year) |
|-------------------------------|---------------------------|---------------------------|
| Cell Room                     | 0.5 - 1.00 ppm            | *                         |
| Chlorine liquefaction section | 6 kg/day                  | 2.19                      |
| Chlorine storage tanks        | 5 kg/day                  | 1.825                     |
| Chlorine cylinder filling     | 5 kg/day                  | 1.825                     |
| HCl synthesis unit            | 6 kg/MT of HCl            | 123.636                   |
| DC tower                      | 5 ppm                     | *                         |
| Neutralisation system         | 1-2%<br>(1.5% avg.)       | 1.344                     |
| Hypo vent                     | 3-10 mg/m <sup>3</sup>    | *                         |

- Negligible quantities and miscellaneous, viz. pipe joints, valves, pipe seals etc.

**Quantity of Chlorine & its Compounds lost during Manufacturing Process per Tonne of Product**

**Unit B**

| Sl. No. | Product                              | Quantity of Chlorine & its Compounds Lost (MT/MT) |         |             |
|---------|--------------------------------------|---|---------|-------------|
|         |                                      | Liquid  | Gaseous | Solid waste |
| 1.      | Liquid chlorine*                     | Nil   | Nil     | Nil         |
| 2.      | HCl (30%)                            | Nil   | Nil     | Nil         |
| 3.      | Stable Bleaching Powder              | Nil   | Nil     | Nil         |
| 4.      | PAC 10%                              | Nil   | Nil     | Nil         |
| 5.      | PAC 14%                              | Nil   | Nil     | Nil         |
| 6.      | PAC 18%                              | Nil   | Nil     | Nil         |
| 7.      | Sodium Hypochlorite (10%)            | Nil   | Nil     | Nil         |
| 8.      | Calcium Hypochlorite / solid waste** | -   | -       | 3-4%        |

\* Chlorine sniff is utilised for HCl (30%) production.

\*\* This is generated from emergency neutralisation of chlorine from all the sections of caustic soda plant.

Calcium hypochlorite is utilised for cement production.

**Estimated Major Contribution of Chlorine Losses**

**Unit C**

| Sl. No. | Emission / discharge sources                | Contribution from sources               | Chlorine losses (MT/year) |
|---------|---|---|---------------------------|
| 1       | Cell Room*                                  | 2 - 3 ppm                               | 0.0942                    |
| 2       | Depleted brine**                            | 15 - 20 g/L                             | -                         |
| 3       | Chlorine liquefaction section (Sniff)***    | 6.405 MT/day                            | 2338                      |
| 4       | Chlorine from Drying Section++              | 3 - 4 kg/day                            | 1.095                     |
| 5       | Chlorine storage tanks (Sniff)***           | 442.5 kg/day                            | 161.5                     |
| 6       | Chlorine cylinder filling+                  | 353.9 kg/day                            | 129.19                    |
| 7       | DC tower+                                   | 895.9 kg/day                            | 327                       |
| 8       | Power failure+                              | -                                       | 10                        |
| 9       | Cell cut off / cut in+                      | -                                       | 30                        |
| 10      | HCl synthesis unit<br>- Tail gas scrubber++ | 5.9 kg/MT of HCl (Chlorine equivalent)  | 139.85                    |
| 11      | CSA Unit<br>- Tail gas scrubber++           | 5.89 kg/MT of CSA (Chlorine equivalent) | 41.10                     |
| 12      | Sodium hypo vent++                          | 2.93 kg/day                             | 1.072                     |
| 13      | Chimney Vent++                              | 6 kg/day                                | 2.19                      |

\* Negligible quantity

\*\* The chlorine discharge from depleted brine is recovered by HCl treatment during recycling

\*\*\* Sniff chlorine utilised in HCl production

+ Waste chlorine absorbed in lime solution (absorption system)

++ Vent out to atmosphere

Note : 1. Remaining losses include cell room, Calcium Hypovent and miscellaneous, viz. pipe joints, valves, pipe seals etc.  
2. The emission discharge from sodium hypo vent is estimated on the basis of efficiency at 99.5%

## Estimated Major Contribution of Chlorine Losses

### Unit D

| Sl. No. | Emission / discharge sources                | Contribution from sources               | Chlorine losses (MT/year) |
|---------|---|---|---------------------------|
| 1       | Cell Room*                                  | 1.0 - 1.5 ppm                           | 0.035                     |
| 2       | Depleted brine**                            | 15 - 20 g/L                             | -                         |
| 3       | Chlorine liquefaction section (Sniff)***    | 3.05 MT/day                             | 1115                      |
| 4       | Chlorine from Drying Section++              | 3 - 4 kg/day                            | 1.277                     |
| 5       | Chlorine storage tanks (Sniff)***           | 400 kg/day                              | 146                       |
| 6       | Chlorine cylinder filling+                  | 328.7 kg/day                            | 120                       |
| 7       | DC tower+                                   | 265.75 kg/day                           | 97                        |
| 8       | Power failure+                              | -                                       | 15                        |
| 9       | Cell cut off / cut in+                      | -                                       | 25                        |
| 10      | HCl synthesis unit<br>- Tail gas scrubber++ | 5.79 kg/MT of HCl (Chlorine equivalent) | 166.7                     |
| 11      | Sodium hypo vent++                          | 2.205 kg/day                            | 0.805                     |
| 12      | Chimney Vent++                              | 3-4 kg/day                              | 1.277                     |

\* Negligible quantity

\*\* The chlorine discharge from depleted brine is recovered by HCl treatment during recycling  
Sniff chlorine utilised in HCl production

\*\*\* Waste chlorine absorbed in lime solution (absorption system)

+ Vent out to atmosphere

++ 1. Remaining losses include cell room, Calcium Hypovent and miscellaneous, viz. pipe joints, valves, pipe seals etc.

Note : 2. The emission discharge from sodium hypo vent is estimated on the basis of efficiency at 99.5%

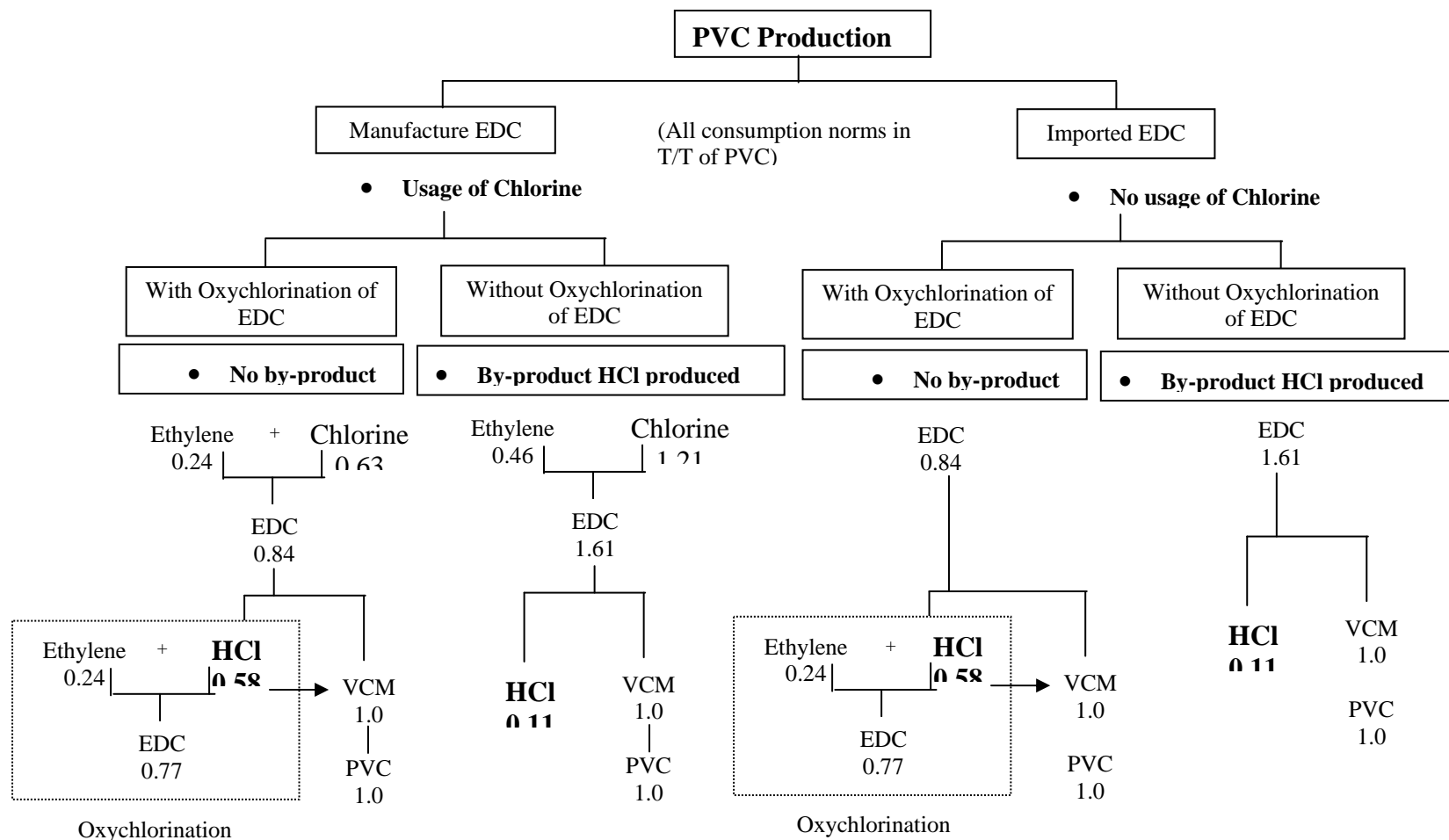

**By-product HCl is produced when facilities for oxychlorination of EDC are not available**

**Chlorine Consumption Based on Quantity and Nature of EDC**

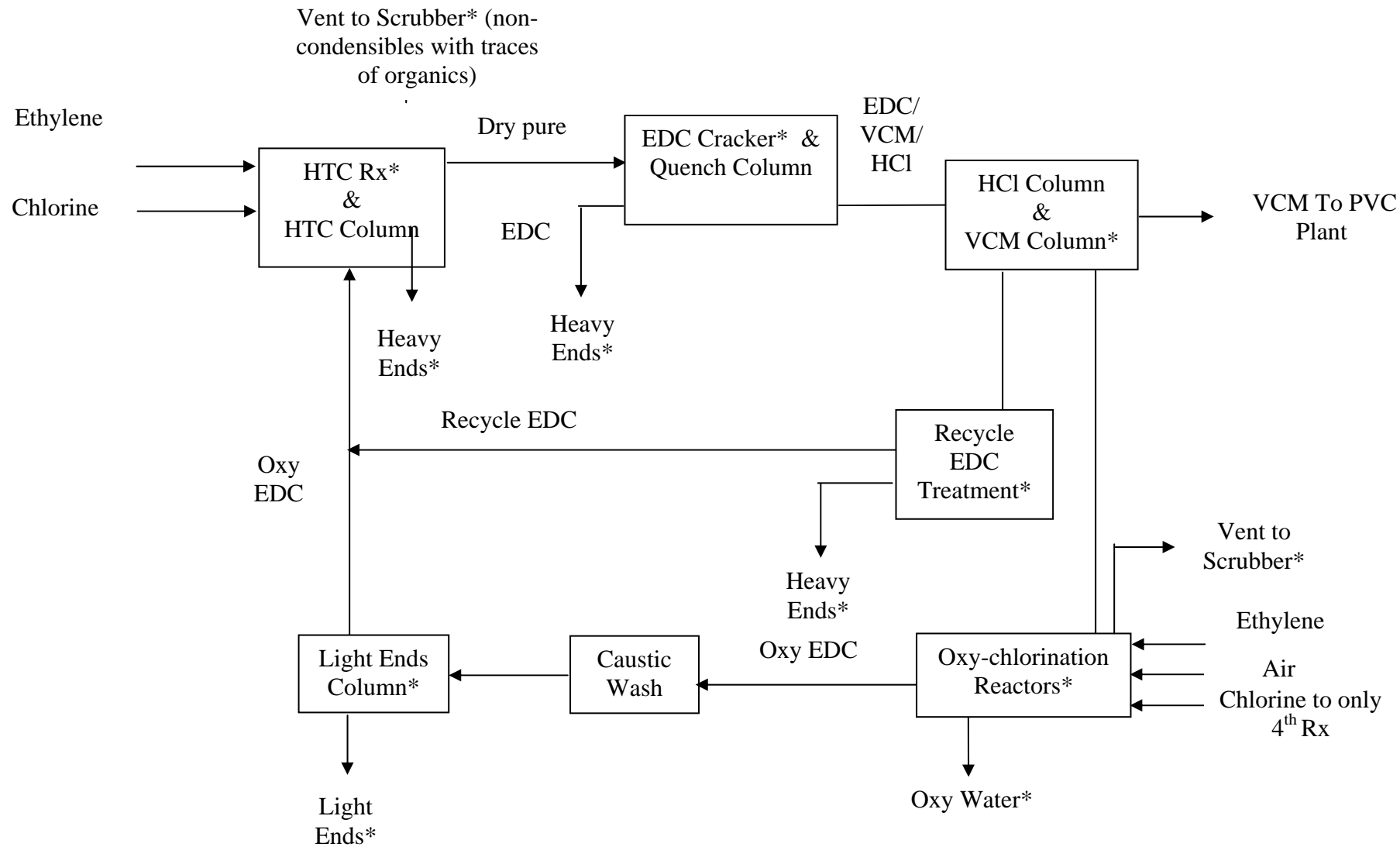

\* : Possible Emission Source

Fig. 1 : Block Diagram of VCM Process

## Process Description and Mass Balance of PVC Production and Chlorine Utilisation

### Unit PVC-I

Vinyl Chloride Monomer is produced through acetylene route and thereby PVC. Acetylene is produced through calcium carbide using limestone from their carbide plant while HCl is obtained from chlorine produced in their chlor-alkali plant. The VCM production through this route is quite expensive.

### Process Description



The reaction between acetylene and HCl takes place in presence of catalyst between 90.6 - 104.6°C temperatures and at 2.5 atmospheric pressure. The reactant is fed to the reactor at 0.427 MT : 0.652 MT. The reaction is highly exothermic and temperature must be controlled carefully. The product gases are compressed, cooled and routed to a purification system. The product is distilled to remove / recovery of acetylene and recycled to reactor.

The unreacted HCl is removed by scrubbing with water followed by deacidification by scrubbing with dilute caustic. VCM containing high boiling impurities is removed by second stage distillation unit. Then VCM is polymerised by suspension process using D.M. water as suspension media. The unreacted VCM is recovered by stripping, compression and condensation. Finally a powder dried PVC resin is obtained by hot air in fluidised bed. The plant has been designed with slurry stripping facility to reduce residual VCM in the product to a very low level.

### The possible emission sources of HCl / VCM :

- VCM synthesis unit
- Compression and condensation
- 1<sup>st</sup> stage distillation
- 2<sup>nd</sup> stage distillation
- Vinyl chloride scrubbers
- VCM storage unit
- VCM polymerisation section
- Polymeriser evacuation

**Mass Balance of PVC Production :** In producing one MT of VCM, 0.659 MT HCl is required and actually consumes 0.591 MT HCl and remaining 0.068 MT HCl is vented through high boilers (0.0012 MT HCl) and 0.0668 MT HCl is drained to ETP.

To produce one MT of PVC, 1.012 MT of VCM is utilised. Out of which, 0.001 MT VCM is emitted through subgrade section and 0.011 MT VCM process losses.

Model Calculations of Mass Balance of PVC Production for the Year 1997-98 is as under :

### HCl Balance :

#### Excess HCl:

|  |                              |
|--|------------------------------|
| Theoretical HCl consumed for PVC Production                            | = norm x PVC production      |
|  | = 0.652 x 28697 = 18710.4 MT |
| Actual, HCl consumed to produce 28,697 MT of PVC                       | = 18,759 MT                  |
| Difference between theoretical and actual HCl consumption (excess HCl) | = 18,759 - 18710.4 = 48.6 MT |



### HCl Emitted:

Considering, 0.068 MT/MT HCl is emitted in VCM production process. Hence HCl emitted during manufacturing PVC =  $0.068 \times 18710.4$   
= 1272.3 MT

Actual HCl consumption = Theoretical HCl - HCl emitted in manufacturing process  
=  $18710.4 - 1272.3 = 17438.1$  MT

### Total HCl losses:

HCl loss during manufacturing = HCl emitted in PVC production + excess HCl  
=  $1272.3 + 48.6 = 1320.9$  MT

Chlorine loss in terms of HCl as HCl is 100% = 1320 MT

### HCl Balance:

Thus, Total HCl consumed in PVC production = Exact HCl consumed + Excess HCl consumed + HCl emitted in PVC production  
=  $17438.1 + 48.6 + 1272.3$   
= 18,759 MT

### **VCM Balance :**

#### Excess VCM:

Theoretical VCM consumption for PVC production = norm x PVC production  
=  $1.012 \times 28,697$  MT  
= 29041.36 MT

Difference between Actual VCM Consumed - Theoretical VCM Consumption  
=  $29079 - 29041.36 = 37.64$  MT

#### VCM Emitted:

Considering, 0.012 MT VCM emitted / MT of PVC,

VCM emitted for 29041.36 MT VCM production = 348.5 MT

Exact VCM utilised to produce 28,697 MT PVC =  $29041.3 - 348.5 = 28692$  MT

Storage / Handling loss of VCM = VCM produced - VCM consumed  
=  $29080 - 29079 = 1$  MT

#### Total VCM losses:

Total loss of VCM = VCM emitted + Excess VCM + Storage / Handling loss of VCM  
=  $348.5 + 37.64 + 1 = 387.1$  MT

#### VCM Balance:

VCM balance = VCM utilised + VCM emitted + Excess VCM + Storage / Handling loss of VCM  
=  $28,692.8 + 348.5 + 37.64 + 1$   
= 29080 MT

### **PVC balance**

Theoretical PVC production = Theoretical VCM consumption / 1.012  
=  $29041.36 / 1.012 = 28696.99$  MT

Actual PVC production = 28697 MT

Theoretical PVC production = Actual PVC production

## Process Description and Mass Balance of PVC Production and Chlorine Utilisation

### Unit PVC-5

The M/s IPCL complex, Vadodara product list include polymers, ethylene glycol, fibre and fibre intermediates, catalysts, benzene, butadiene, ethylene, ethylene oxide, hydrocyanic acid, propylene, ortho and mixed xylene, para-xylene and other chemicals.

The poly vinyl chloride (PVC) is produced using Vinyl chloride monomer (VCM) by suspension polymerisation. VCM is produced using chlorine and ethylene by Balane process. The raw ethylene is obtained from their plant and whereas chlorine is from M/s Gujarat Alkalies & Chemicals Limited (GACL), Vadodara. On the basis of information provided, site visit and through discussion with the industry officials, the mass balance is estimated and presented in this report.

### Process Description :

**Vinyl Chloride Monomer Plant :** The VCM process involves direct and oxy-chlorination of ethylene to form intermediate ethylene dichloride and thermal cracking of ethylene dichloride (EDC) to form VCM. The chemical reaction for VCM production is as under.

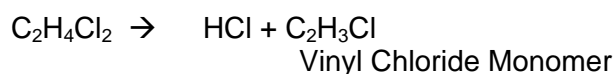
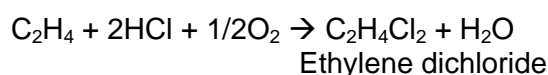
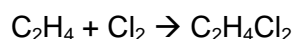

The process plant has the following sections :

- High temperature chlorination (HTC) and EDC purification
- EDC cracking and quenching
- Recycle EDC treatment
- Oxy-chlorination
- Oxy-EDC treatment and
- Incineration

**HTC and EDC Purification :** Ethylene and gaseous chlorine are allowed to react in presence of ferric chloride as catalyst to form EDC by direct chlorination in HTC reactor. The reaction is exothermic and heat is utilised in the HTC column attached to reactor to provide heat load for EDC purification. The dry pure EDC product is sent to intermediate storage before cracking. The purge liquor from HTC reactor is drawn-off and heated in tar still and the EDC is recovered in EDC recovery column. The tar still bottoms are sent to heavy ends storage.

**EDC Cracking and Quenching :** The pure EDC liquid from storage is preheated to vapourise and sent for cracking at 490°C. The cracked gas containing VCM, HCl and uncracked EDC is quenched to 160°C in quench column. Bottoms are sent to tar-still for recovery of EDC and the heavy ends are sent to storage.

The vapours leaving quench column are fed to HCl column for separation of HCl (as 100%) from column top by propylene refrigerated condenser (-36°C and 7.9 kg/cm<sup>2</sup>). The HCl column bottom containing EDC and VCM is fed to VCM column to separate VCM product from top, which after passing through caustic dryer is sent to VCM product storage.

**Recycle EDC Treatment :** The VCM column bottom containing recycle EDC and heavy ends is chlorinated to remove chloroprene and then dechlorinated by ethylene. This recycle EDC is flash distilled to remove EDC and sent to HTC column for purification. The heavy end stream is sent to VCM tar still for separation of heavy ends.

**Oxy-chlorination :** HCl vapours combined with preheated ethylene and process air are fed to first oxychlorination reactor which is filled with  $\text{CuCl}_2$  catalyst on tubes side. The heat of reaction is utilised by water flowing on the shell side and  $17.5 \text{ kg/cm}^2$  steam is generated. The reactor effluent then goes to second and third reactor in series and steam is generated.

The reactor effluent from third reactor is cooled to separate EDC and water, which are sent for purification and recovery in HTC section. The uncondensed gases containing excess ethylene are mixed with chlorine and fed to fourth oxy-reactor. The reactor effluents are cooled to separate EDC / water and gases sent to vent header. All the vent gases in the plant are released to atmosphere after scrubbing with caustic solution in the vent scrubber.

### Oxy-EDC Treatment

- EDC Washing : The oxy EDC is washed with 2-5% of caustic solution and the wet crude EDC is removed from caustic wash decanter and sent to storage.
- Light Ends Removal : The wet crude oxy EDC is sent to light ends column where dry crude oxy EDC is taken out from bottom and sent to HTC column for purification. Water is separated from light ends in overhead vapour and sent for steam stripping. The light ends from top are sent to storage.

**Incineration :** The light ends and heavy ends produced in the process are incinerated to recover HCl (30%). Steam is also produced in the waste heat boiler.

### PVC Plant

**Process Description :** Poly vinyl chloride (PVC) is produced by the Suspension Batch Polymerisation of Vinyl Chloride Monomer (VCM) in presence of catalyst. The chemical reaction in PVC manufacturing is as under.

Catalyst

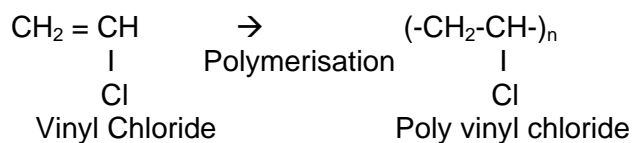

The process consists of the following components:

- Additive Preparation
- Polymerisation
- Blowdown and VCM Recovery
- Slurry Stripping
- Drying and Bagging

**Additive Preparation :** The additives required in polymerisation process are prepared by making solutions of required recipe and concentration and kept in storage tanks. The additive solutions are coating solution, buffer, emulsifier, catalyst and shortstop.

**Polymerisation :** Polymerisation process is a batch process. These are three agitated polymerisers, each of them will be in different stage of operation at any time.

Poly reactor is first coated with a chemical solution to inhibit polymer adhesion to the reactor walls. The recipe for PVC grade is then calculated. Firstly buffer, DM Water, VCM (Fresh / Recovered VCM) and emulsifier are charged to poly reactor. Then catalyst is added and reaction is started. The reaction temperature is maintained by cooling water and chilled water circulation in reactor jacket and baffles respectively. The reaction proceeds for about 5-6 hours and reactor level is maintained by continuous addition of DM water to poly reactor. At about 75-80% VCM conversion, the reaction is terminated by adding shortstop. The PVC slurry is then pumped to Blowdown Tank for unconverted VCM recovery. The poly reactor after required flushing is made ready for next charging. The poly reactor charging, reaction control, monitoring and slurry blowdown operations are operated by computer control.

**Blowdown and VCM Recovery :** The VCM recovery system consists of recovery condensers and compressors. PVC slurry from poly reactor with unconverted VCM is flashed in blowdown tank to remove most of the VCM in slurry as vapour. The VCM vapour is condensed and reused in process as recovered VCM.

The inerts in the system are vented to atmosphere through an Absorber / Stripper System. The VCM in vent is absorbed by a solvent (n-Heptane) and the solvent is stripped to remove VCM which is recovered and reused. The solvent is recycled.

**Slurry stripping / Wastewater stripping :** The PVC slurry, after blowdown is stripped with steam in stripping column to remove the remaining VCM, which is recovered in the recovery section. The stripped slurry is sent to agitated blend tanks.

All the wastewater streams containing VCM are stripped in wastewater stripper to remove VCM before putting into wastewater pit.

**Dewatering, Drying and Bagging :** The PVC slurry in Blend Tank is fed to centrifuge to separate about 70-75% of water from the slurry. The water is sent to wastewater pit to remove suspended PVC particles as wet resin. The centrifuged wet resin is fed to Rotary Air Dryer to dry the resin, which is separated from air and after screening is conveyed to check silos and product silos. The PVC product is bagged by automatic weighing and bagging machine.

## **The possible emission sources in VCM / PVC plant**

### **VCM Plant :**

- High temperature chlorination (HTC)
- EDC purification
- EDC cracking
- EDC quenching
- EDC quenching column
- Oxy-EDC treatment system
- Incineration system
- Vent scrubber
- VCM storage tank

### **PVC Plant :**

- VCM storage tanks
- Polymerisation reactor
- VCM blowdown and recovery system
- Slurry stripping
- VCM vent gas recovery
- Wastewater stripping

- Slurry blend tank

The locations of possible emission sources in VCM and PVC manufacturing are depicted in Figs. 1 & 2 respectively.

### **Emission Control Measures :**

#### **1. Waste from VCM manufacture**

##### **a. Chlorinated Hydrocarbon**

- i. High Temperature Chlorination: The heavy ends generated from high temperature chlorination reactor is removed and processed in tar-still. The heavy ends are stored and incinerated.
- ii. Cracker Heavy Ends: The heavy ends from quench column and recycle EDC treatment are processed in quench tar-still. The tar produced from this is stored in heavy ends tank.
- iii. Light Ends: The light ends from HTC / cracker / oxy section are accumulated at light ends column and recovered as light end. Light ends are stored in light ends storage tank.

All the VCM process vent gases temperature will be brought down and scrubbed with water / NaOH.

**b. Wastewater from VCM Plant :** Normally the oxy-chlorination produces reaction water containing hydrochloric acid. After neutralisation, the waste is subjected to biological treatment at Central Wastewater Treatment Plant located in the complex.

The other source of water is vent scrubber where all the vent gases coming from VCM process are scrubbed. This water is sent to central wastewater treatment plant of IPCL for further treatment.

**2. Waste from PVC manufacture :** PVC is produced by suspension polymerisation. The suspension is centrifuged and the centrate water is sent to central wastewater treatment plant of IPCL.

### **Handling of Chlorine / VCM Gas Leakages**

- A provision has been made for emergency handling of chlorine, VCM and HCl leakages.
- Safety valves are provided with rupture disc to avoid fugitive emissions
- The on-line VCM monitors in vinyl chloride (10 locations) and PVC plant (14 locations) are placed to monitor the VCM emissions. The monitors are checked once in a month by central safety, central instrument department and plant safety engineer. The list of locations of VCM monitors in VCM and PVC plants is presented in **Table 1**.

In VCM plant two chlorine gas detectors are installed near chlorine compressor area and chlorine control valve of HTC reactor.

M/s IPCL has adequate power requirement through two gas turbines (62 MWH). In the event of turbines tripping, power from state board (35 MWH) as backup facility is automatically switched on.

The chlorine balance in VCM plant provided by M/s IPCL is presented in **Table 2**.

Model calculations of mass balance of VCM, PVC and chlorine consumption for the year 2000-01 is as under :

### VCM Balance :

VCM consumption as per norm for PVC production

$$= \text{VCM consumption norm} \times \text{PVC production}$$

$$= 1.039 \times 50,829$$

$$= 52811.3 \text{ MT}$$

$$\text{Actual VCM utilized} = 52831 \text{ MT}$$

Difference between VCM consumption as per norm & Actual VCM utilized

$$= 52831 - 52811.3 = 19.7 \text{ MT}$$

On an average 1.039 VCM is required for one MT of PVC.

Considering 0.039 MT VCM process loss (all sources) per MT VCM consumed.

$$\text{VCM unaccounted / loss in PVC production} = 0.039 \times \text{VCM consumption as per norm}$$

$$= 0.039 \times 52811.3 = 2059.6 \text{ MT}$$

$$\text{VCM unaccounted / loss in PVC production} = 2059.6$$

As VCM contain 57% chlorine in VCM molecule.

$$\text{Chlorine equivalent in terms of VCM} = 2059.6 \times 0.57 = 1173.97 \text{ MT}$$

Actual VCM utilised to produce 50,829 MT PVC

$$= \text{VCM consumption as per norm} - \text{VCM unaccounted / loss}$$

$$= 52811.3 - 2059.6$$

$$= 50751.7 \text{ MT}$$

$$\text{VCM balance} = \text{VCM actually utilised in PVC production} +$$

$$\text{VCM unaccounted / loss in PVC production} + \text{difference in VCM consumption}$$

$$52831 \text{ MT} = 50751.7 + 2059.6 + 19.7$$

$$= 52831 \text{ MT}$$

### PVC Balance :

Theoretical PVC production

$$= \text{VCM consumed as per norm} / \text{VCM consumption norm}$$

$$= 52811.3 / 1.039$$

$$= 50,829 \text{ MT}$$

$$\text{Actual PVC production} = 50,829 \text{ MT}$$

$$\text{Actual PVC production} = \text{Theoretical PVC production}$$

### Chlorine balance :

$$\text{Chlorine consumed as per norm for VCM production} = \text{norm} \times \text{VCM production}$$

$$= 0.673 \times 51255$$

$$= 34494.6 \text{ MT}$$

One MT VCM utilised 0.57 MT chlorine equivalent in VCM.

Therefore, considering 0.103 MT of chlorine / MT VCM production as process losses.

$$\text{Chlorine unaccounted / loss during VCM production} = 0.103 \times 34494.6$$

$$= 3552.9 \text{ MT}$$

$$\text{Chlorine consumed as per norm for 51255 MT VCM production} = 34494.6 - 3552.9$$

$$= 30941.7 \text{ MT}$$

Thus, chlorine unaccounted / loss in PVC production

$$= \text{Chlorine unaccounted / loss in VCM production} +$$

$$\text{chlorine unaccounted / loss in terms of VCM in PVC production}$$

$$= 3552.9 + 1173.97$$

$$= 4726.87 \text{ MT}$$

The total quantity of unaccounted / loss chlorine equivalent (chlorinated waste and PVC powder in wastewater) was 4726.87 MT during 2000-01.

**Table 1: VCM Monitoring Points in VC / PVC Plant****VCM Plant**

| <b>Sl. No.</b>                   | <b>Location</b>   | <b>No. of Monitors</b> |
|----------------------------------|---|------------------------|
| 1.                               | Quench column   | 1                      |
| 2.                               | HCl column  | 2                      |
| 3.                               | Cracker area  | 2                      |
| 4.                               | VCM column  | 3                      |
| 5.                               | VCM storage tank  | 1                      |
| 6.                               | Sphere tank farm area                                     | 1                      |
|                                  | <b>Total</b>  | <b>10</b>              |
| <b>LEL Detectors (VCM Plant)</b> |   |                        |
| 7.                               | Cracker   | 1                      |
| 8.                               | York compressor - 1 <sup>st</sup> & 2 <sup>nd</sup> Floor | 2                      |
|                                  | <b>Total</b>  | <b>3</b>               |

**PVC Plant**

| <b>Sl. No.</b>            | <b>Location</b>   | <b>No. of monitors</b> |
|---------------------------|---|------------------------|
| 1.                        | Emulsifier storage tank in additive section                                 | 1                      |
| 2.                        | VCM blow down recovery separator - 1 <sup>st</sup> & 2 <sup>nd</sup> floors | 2                      |
| 3.                        | Polymerisation reactors bottom  | 3                      |
| 4.                        | Slurry stripper feed pump storage   | 1                      |
| 5.                        | Recovery compressor   | 1                      |
| 6.                        | Polymerisation reactor top & bottom   | 3                      |
| 7.                        | VCM storage (Day tank) bottom   | 2                      |
| 8.                        | Slurry blow down tank   | 1                      |
|                           | <b>Total</b>  | <b>14</b>              |
| <b>Water Spray Points</b> |   |                        |
| 9.                        | Vent gas recovery (ground / second floor)                                   | 1                      |
| 10.                       | Ply (ground / second floor)   | 2                      |
|                           | <b>Total</b>  | <b>3</b>               |

**Table 2: Chlorine Balance (VCM Plant)**

| Item  | Legend                         | 2000-01 | 1999-00 | 1998-99 |
|---|--------------------------------|---------|---------|---------|
|   |                                | MT/year |         |         |
| Input   |                                |         |         |         |
| Cl <sub>2</sub> (GACL)                            | A                              | 27481   | 31200   | 32712   |
| EDC (GC)  | B                              | 10166   | 6832    | 3792    |
| Cl <sub>2</sub> Eq (EDC, GC)                      | $C = B \cdot 0.717$            | 7289    | 4899    | 2719    |
| EDC inventory change                              | D                              | 637     | 202     | (-) 612 |
| Cl <sub>2</sub> Eq EDC inventory                  | $E = D \cdot 0.717$            | (-) 457 | (-) 145 | 439     |
| Net Cl <sub>2</sub> consumption                   | $F = A + C + E$                | 34313   | 35954   | 35870   |
| Output  |                                |         |         |         |
| Net VCM production                                | G                              | 51255   | 55506   | 55502   |
| Cl <sub>2</sub> Eq VCM                            | $H = G \cdot 0.568$            | 29113   | 31527   | 31525   |
| Heavy Ends  | I                              | 1686    | 1908    | 982     |
| Light Ends  | J                              | 509     | 859     | 352     |
| Chlorinated Slop Oil / Heavy Chloro Carbon Liquid | K                              | 488     | 464     | 407     |
| Total byproducts                                  | $L = I + J + K$                | 2683    | 3231    | 1741    |
| Cl <sub>2</sub> Eq chlorinated byproducts         | $M = L \cdot 0.75$             | 2012    | 2423    | 1306    |
| Oxy water flow                                    | N                              | 8000    | 8000    | 8000    |
| Cl <sub>2</sub> eq. @ 1% Wt EDC in oxy water      | $O = N \cdot 0.01 \cdot 0.717$ | 57      | 57      | 57      |
| Cl <sub>2</sub> in vent / wastewater              | P                              | 861     | 861     | 861     |
| Caustic cons. (@20%)                              | Q                              | 9696    | 7324    | 5523    |
| Caustic eq. 100%                                  | $R = Q / 5$                    | 1939    | 1465    | 1105    |
| Cl <sub>2</sub> eq. HCl neutralised by NaOH       | S                              | 1712    | 1293    | 975     |
| Net chlorine consumed                             | $T = H + M + O + P + S$        | 33755   | 36162   | 34724   |



## Unit PVC-I

|                                |                           |
|--------------------------------|---------------------------|
| Licensed Capacity (MT / Annum) | 33,000                    |
| Installed capacity             | 33,000 MT                 |
| Process                        | Suspension polymerisation |
| Designed process losses        | 4%                        |

## Raw Material used per MT of Product

| Material                 | Consumption (MT/MT) |
|--------------------------|---------------------|
| Acetylene                | 0.427               |
| Hydrochloric Acid (100%) | 0.652               |
| VCM                      | 1.012               |

## Production Statistics

| Year    | VCM production (MT) | PVC production (MT) |
|---------|---------------------|---------------------|
| 1997-98 | 29,080              | 28,697              |
| 1998-99 | 22,489              | 22,216              |
| 1999-00 | 28,986              | 28,546              |

## Actual HCl and VCM Consumption

| Year    | HCl (MT) | VCM (MT) |
|---------|----------|----------|
| 1997-98 | 18,759   | 29,079   |
| 1998-99 | 14,509   | 22,505   |
| 1999-00 | 18,660   | 28,923   |

## Mass Balance of PVC production

| Sl. No.            | Description   | Quantity in MT |             |             |
|--------------------|---|----------------|-------------|-------------|
|                    |   | 1999-2000      | 1998 - 1999 | 1997 - 1998 |
| 1.                 | PVC Production  | 28546          | 22216       | 28697       |
| 2.                 | VCM Production  | 28986          | 22489       | 29080       |
| <b>HCl Balance</b> |   |                |             |             |
| 3.                 | Actual HCl consumed   | 18660          | 14509       | 18759       |
| 4.                 | HCl consumption for PVC by Norms  | 18612          | 14485       | 18710       |
| 5.                 | Difference between theoretical and actual HCl consumption (excess HCl)  | 48             | 24          | 49          |
| 6.                 | HCl vented / lost during manufacturing of PVC (considering 0.068 MT/MT) | 1265.6         | 985         | 1272        |
| 7.                 | Total HCl Loss  | 1313.6         | 1009        | 1321        |
| <b>VCM Balance</b> |   |                |             |             |

|                               |  |       |       |       |
|-------------------------------|--|-------|-------|-------|
| 8.                            | Actually VCM consumed  | 28923 | 22505 | 29079 |
| 9.                            | Theoretical VCM consumption for PVC ( Norm = 1.012 MT/MT PVC)      | 28888 | 22482 | 29041 |
| 10.                           | Difference between theoretical and actual VCM consumption (excess) | 35    | 23    | 38    |
| 11.                           | VCM lost during manufacturing process                              | 347   | 270   | 348   |
| 12.                           | Storage / Handling Losses  | 63    | -16   | 1     |
| 13.                           | Total VCM losses   | 445   | 277   | 387   |
| <b>PVC Production Balance</b> |  |       |       |       |
| 14.                           | Theoretical PVC Production   | 28546 | 22216 | 28697 |
| 15.                           | Actual PVC production  | 28546 | 22216 | 28697 |

### Major Sources and Contributions of VCM Losses from PVC Plant

| Emission / discharge sources   | Contribution from sources       | VCM Loss (MT/year) |
|--|---------------------------------|--------------------|
| <ul style="list-style-type: none"> <li>VCM synthesis unit</li> <li>Compression and condensation</li> <li>1<sup>st</sup> stage distillation</li> <li>2<sup>nd</sup> stage distillation</li> <li>Vinyl chloride scrubbers</li> <li>VCM polymerisation section</li> <li>Polymeriser evacuation</li> </ul> | *Process Loss : 0.011 MT/MT VCM | 319.45             |
| VCM storage / handling   | 2.73 kg/day                     | 1.0                |
| Sub grade losses   | *0.001 MT/MT VCM                | 29.0               |
| Miscellaneous <ul style="list-style-type: none"> <li>Excess VCM consumed (difference between theoretical and actual consumption)</li> </ul>  | -                               | 37.64              |

\* Theoretical VCM consumption for PVC production = 29,041 MT/year

**Unit PVC-II**  
**Raw Materials Utilisation**

| Sl. No. | Description | Actual Consumption Norm (MT/MT) |         |         | Quantity (MT) |         |         |
|---------|-------------|---------------------------------|---------|---------|---------------|---------|---------|
|         |             | 1998-99                         | 1999-00 | 2000-01 | 1998-99       | 1999-00 | 2000-01 |
| 1       | Chlorine*   | 0.657                           | 0.664   | 0.673   | 32717         | 31200   | 27481   |
| 2       | Ethylene*   | 0.516                           | 0.514   | 0.549   | 27163         | 26463   | 25408   |
| 3       | VCM**       | 1.025                           | 1.025   | 1.039   | 56847         | 55582   | 52831   |
| 4       | EDC***      | -                               | -       | -       | 3792          | 6832    | 10166   |

\* Input for VCM production ; \*\* Input for PVC production; \*\*\* EDC from other plant

**Production Details**

| Year    | PVC production (MT) | VCM production (MT) |
|---------|---------------------|---------------------|
| 1998-99 | 55,472              | 55502               |
| 1999-00 | 54,252              | 55506               |
| 2000-01 | 50,829              | 51255               |

Note : EDC and HCl are used as intermediates

**Quantity of chlorine lost during manufacturing process per MT of product**

| Year    | Chlorine (MT/MT VCM) | VCM (MT/MT PVC) |
|---------|----------------------|-----------------|
| 1998-99 | 0.005                | 0.005           |
| 1999-00 | 0.013                | 0.005           |
| 2000-01 | 0.031                | 0.019           |

**Summary of Mass Balance of VCM, PVC and Chlorine Consumption**

| Sl. No.            | Description  | Quantity (MT) |         |         |
|--------------------|--|---------------|---------|---------|
|                    |  | 2000-01       | 1999-00 | 1998-99 |
| 1                  | PVC production   | 50829         | 54252   | 55472   |
| 2                  | VCM production   | 51255         | 55506   | 55502   |
| 3                  | Chlorine   | 27481         | 31200   | 32717   |
| 4                  | Chlorine eq. of EDC*   | 7289          | 4898.5  | 2718.9  |
| 5                  | Chlorine eq. EDC inventory   | (-) 457       | (-) 145 | 439     |
| 6                  | Total chlorine consumed (3+4)  | 34770         | 36098.5 | 35435.9 |
| <b>VCM Balance</b> |  |               |         |         |
| 7                  | VCM consumption as per norm for PVC production                         | 52811.3       | 55608.3 | 56858.8 |
| 8                  | Difference between VCM consumption as per norm and actual VCM consumed | 19.7          | (-)26.3 | (-)11.8 |

|                               |   |         |          |          |
|-------------------------------|---|---------|----------|----------|
| 9                             | VCM unaccounted / loss during manufacturing process         | 2059.6  | 1390.2   | 1421.47  |
| 10                            | Chlorine eq. loss in terms of VCM                           | 1173.97 | 792.4    | 810.23   |
| <b>PVC Production Balance</b> |   |         |          |          |
| 11                            | Theoretical PVC production                                  | 50,829  | 54,252   | 55,472   |
| 12                            | Actual PVC production                                       | 50,829  | 54,252   | 55,472   |
| <b>Chlorine Balance</b>       |   |         |          |          |
| 13                            | Chlorine consumption as per norm for VCM production         | 34494.6 | 36855.98 | 36464.8  |
| 14                            | Actual chlorine utilised                                    | 30941.7 | 33391.52 | 33292.37 |
| 15                            | Chlorine unaccounted / loss during VCM production           | 3552.9  | 3464.46  | 3172.43  |
| 16                            | Total chlorine unaccounted / loss in PVC production (10+15) | 4726.87 | 4256.86  | 3982.66  |

\* Chlorine eq. of EDC = 0.717 x EDC from IPCL, Gandhar Plant

#### Major Sources and Contributions of Chlorine eq. in VCM Plant

| Emission / discharge sources  | Contribution from sources                 | VCM Loss Chlorine eq. (MT/year) |         |         |
|---|---|---------------------------------|---------|---------|
|   |   | 00-01                           | 99-00   | 98-99   |
| <ul style="list-style-type: none"> <li>VCM synthesis unit</li> </ul>  | Process Loss: 0.086 MT / MT VCM           |                                 |         |         |
| <b>Chlorinated waste from</b> <ul style="list-style-type: none"> <li>High chlorination</li> <li>EDC cracking</li> <li>Oxy-chlorination</li> <li>EDC Purification</li> </ul> | 0.045 MT/MT VCM (Heavy ends / Light ends) | 2306.48                         | 2497.77 | 2497.59 |
| <b>Wastewater</b> <ul style="list-style-type: none"> <li>Oxy-chlorination</li> <li>Vent scrubber</li> <li>Floor washing</li> </ul>  | 0.04 MT/MT VCM                            | 2050.2                          | 2220.24 | 2220.08 |
| <b>Atmospheric vent</b><br>All vents are through scrubber   | 0.001 MT/MT VCM                           | 51.255                          | 55.506  | 55.502  |

#### Major Sources and Contributions of Chlorine Losses in Terms of VCM

| Emission / discharge sources   | Contribution from sources    | Chlorine Loss in Terms of VCM (MT/year) |        |        |
|--|------------------------------|---|--------|--------|
|  |                              | 00-01                                   | 99-00  | 98-99  |
| <b>PVC synthesis unit</b> <ul style="list-style-type: none"> <li>VCM column</li> <li>Polymerisation reactor</li> <li>VCM blowdown and recovery system</li> <li>Slurry stripping</li> <li>VCM recovery</li> <li>Wastewater stripping</li> <li>Slurry blowdown tank</li> </ul> | Process Loss: 0.02 MT/MT VCM | 602.27                                  | 633.63 | 648.05 |

HCL 0.659 MT

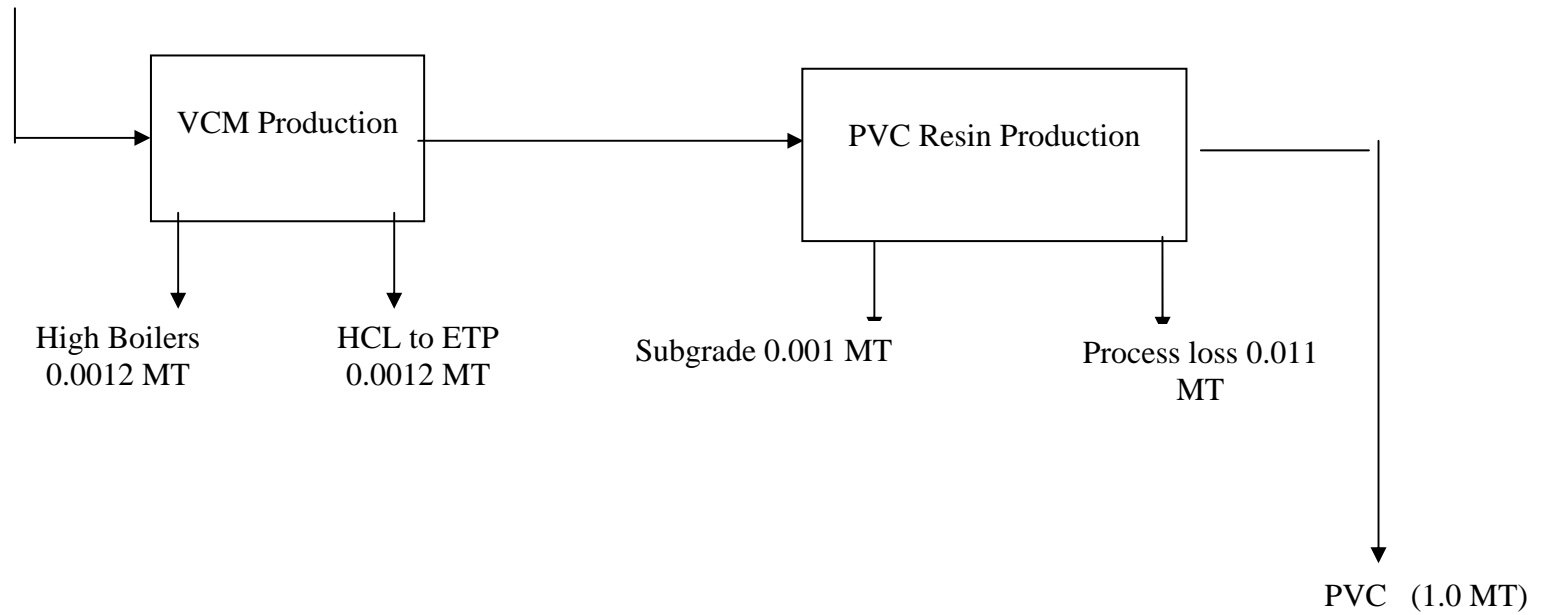

**Stoichiometric Mass Balance of Chlorine per Ton of PVC Production in an Acetylene Route Plant**

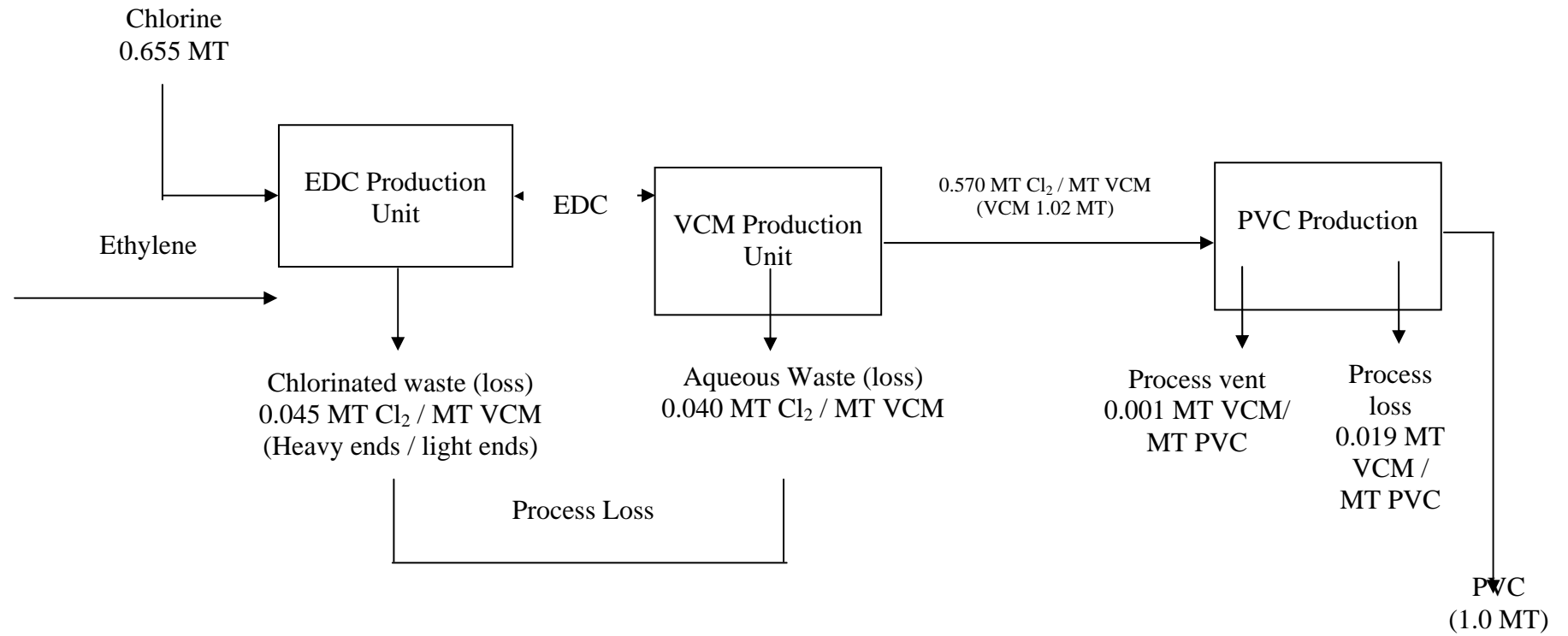

**Stoichiometric Mass Balance of Chlorine per Ton of PVC Production in an Ethylene Route Plant**

### Major Applications, Grades and Properties of Chlorinated Paraffin Wax (CPW)

Chlorinated paraffins (CP) are manufactured, varying both in chlorine content and carbon chain length of paraffin oil, to give varieties of properties to meet the requirements of different applications. Chlorinated paraffins are inert, insoluble in water and are susceptible to degradation with the formation of hydrochloric acid on continuous exposure to high temperature. They are non-flammable secondary plasticizers used in vinyl compositions to replace the costly primary phthalate plasticizers and phosphate esters, thus reducing the unit cost of compound and also impart technical improvements to the following properties :

- Flame Resistance
- Low Temperature Flexibility
- Stain Resistance
- Resistance to Aqueous Detergent Extraction
- Resistance to Chemicals
- Plastisol Viscosity Stability

#### Grades & Properties

| Grade | Chlorine Content | Sp. Gravity at 25°C | Viscosity at 25°C (in poises) | Heat Stability at 180°C |
|-------|------------------|---------------------|-------------------------------|-------------------------|
| CP-45 | 45% ± 2%         | 1.21 to 1.23        | 2 to 4                        | 60 mins. Min.           |
| CP-52 | 50% ± 2%         | 1.26 to 1.28        | 17 to 25                      | 60 mins. Min.           |
| CP-58 | 57% ± 2%         | 1.35 to 1.37        | 175 to 225                    | 60 mins. Min.           |

**Applications:** Chlorinated paraffins are used in PVC flooring, leather cloth, cables, shoe compounds, pipes and tubes, sleeve, wall covering, belting, suction hose, general extrusion compounds and also for semi-rigid compounds under special circumstances, as also in extreme pressure lubricants in cutting oil industry.

For PVC application, the most preferred grades are with minimum chlorine content of 45%, 52% and 58%. The 45% grade which is used for plastisol formulation giving good viscosity stability to stored product and also for optimal low temperature performance, the 52% grade for general purpose compounds giving maximum cost saving and improved flame resistance, and the 58% grade where low volatility and low migration is of paramount importance to use in conjunction with polymeric primary plasticizers.

With increasing chlorine content, increasing specific gravity, compatibility with PVC is increased, however, the plasticizing efficiency is reduced. The viscosity of chlorinated paraffins depends on the carbon chain distribution of the raw material used and with lowering the carbon chain length, viscosity will reduce and vice-versa. Also the carbon chain distribution of the raw material directly affects the volatility of chlorinated paraffin.

**Advantages:** Chlorinated paraffins are used as secondary plasticizers. They also give several advantages, viz. tensile strength and modulus increase, electrical properties increase volume resistivity and flame retardancy. Chlorinated paraffins can be conveniently used as a fire retardant additive with effective synergistic effect with antimony trioxide giving improved critical oxygen index. The cost of a PVC compound is calculated on the basis of volume only and not on weight basis, as volume directly affects the output. Special grades of CP with 40% and 65% chlorine content in liquid form can be produced with low viscosities suitable to use in paint, rubber, leather, mineral oil and textile etc.

## Process description along with model calculation on mass balance of chlorine utilization

### Unit CBW-1

**Process Description :** Raw heavy normal paraffin (HNP) is heated electrically to the required temperature in HNP storage tank and measured quantity of heavy normal paraffin is charged into reactor (chlorinator). A block diagram for CPW production is depicted in **Fig. 1**. The chlorine gas is bubbled through the HNP in a reactor in which the reaction between HNP and chlorine takes place. It is an exothermic reaction. During reaction, hydrochloric gas liberated is scrubbed in two water scrubbers, where the hydrochloric gas is converted into hydrochloric acid. The dilute hydrochloric acid formed is continuously recirculated in the system until the desired concentration of hydrochloric acid is attained.

The balance hydrochloric gas is then fed in to the bubbling tank where rest of the hydrochloric gas is converted to hydrochloric acid. In the final stage the left over gases, mostly unreacted chlorine, are taken to the alkali tower, where alkali solution is fed counter-currently to absorb any unabsorbed hydrochloric gas and unreacted chlorine. The calcium hypo scrubber is operated with milk of lime solution counter-currently to the flow of gases from the process plant. Temperature is maintained in the reactor by cooling water circulation. Hydrochloric acid formed in water scrubber is being cooled in condenser before recirculating to water scrubber.

After completion of reaction, the product, chlorinated paraffin wax, obtained in the reactor is separated for removal of any free gases. The chlorinated paraffin was then obtained is filled in to drums for dispatch. Hydrochloric acid obtained as a by-product is stored in storage tank and is dispatched.

**Mass Balance of Chlorine Utilisation :** The model calculation on mass balance of chlorine utilisation for the year 1996-97 is presented as under :

#### **Theoretical (1996 - 97) :**

Theoretically, 1.05 T of chlorine required per tonne of CPW production

Chlorine consumed for CPW production = chlorine consumption norm x CPW production

Chlorine consumption for 603 T of CPW =  $1.05 \times 603 = 633.15$  T

Actual chlorine consumed to produce 603 T of CPW = 785 T

Difference between theoretical and actual chlorine consumption (T)

= Actual chlorine consumed - theoretical chlorine required

=  $785 - 633.15 = 151.85$  T

151.85 T of excess chlorine is utilised than the theoretical consumption norm.

785 T of chlorine utilised to produce 603 T of CPW. As per the reaction, 0.51 T of HCl (100%) could have been produced per tonne of CPW.

Theoretical HCl (100%) produced during CPW production =

= Quantity of HCl produced per T of CPW x CPW production

=  $0.51 \times 603 = 307.5$  T

HCl (30%) production =  $307.5 \times 3.3 = 1014.75$  T

Theoretically,

Chlorine utilised for CPW production

= CPW production x chlorine equivalent per tonne of CPW

=  $603 \times 0.499 = 300.89$  T

Chlorine utilised for HCl production (30%)

= HCl production (30%) x Chlorine eq. per tonne of HCl

=  $1014.75 \times 0.3 = 304.42$  T



Total chlorine utilised in CPW and HCl production  
 = Chlorine utilised for CPW + Chlorine utilised for HCl (30%)  
 = 300.89 + 304.42 = 605.31 T

Theoretical chlorine unutilised during consumption = 633.15 - 605.31 = 27.84 T

Total theoretical chlorine loss in 603 T CPW production  
 = Excess chlorine utilised + chlorine unutilised  
 = 151.85 + 27.84 = 179.69 T

Total chlorine loss (theoretical) = 179.69 T

The above quantity does not include handling and process losses to the extent of 5%.

**Actual Situation in Industry (1996-97) :**

Chlorine consumed for CPW production  
 = Chlorine consumption norm x CPW production  
 = 1.3 x 603 = 783.9 T

Actual HCl produced (30%) = 1200 T

Chlorine utilised for CPW production  
 = CPW production x chlorine equivalent per tonne of CPW  
 = 603 x 0.588 = 354.56 T

Chlorine utilised for HCl (30%) = HCl production x Chlorine eq. per tonne of HCl  
 = 1200 x 0.3 = 360 T

Total chlorine utilised for CPW and HCl production = 354.56 + 360 = 714.56 T

Chlorine unreacted / loss in CPW manufacturing process  
 = chlorine consumed - quantity of chlorine utilised  
 = 785 - 714.56 = 70.44 T

Chlorine unreacted / loss in CPW manufacturing process = 70.44 T

As per the data, out of 1300 kg chlorine utilisation per T of CPW production, 90 kg chlorine is neutralised i.e. waste by Calcium hypo system.

For 785 T chlorine utilisation, the quantity of chlorine loss / neutralised by calcium-hypo

$$= \frac{785 \times 0.09}{1.3} = 54.35 \text{ T}$$

Chlorine vented into the atmosphere

= Total chlorine unreacted / loss - chlorine neutralised / loss by calcium hypo system  
 = 70.44 - 54.35 = 16.09 T

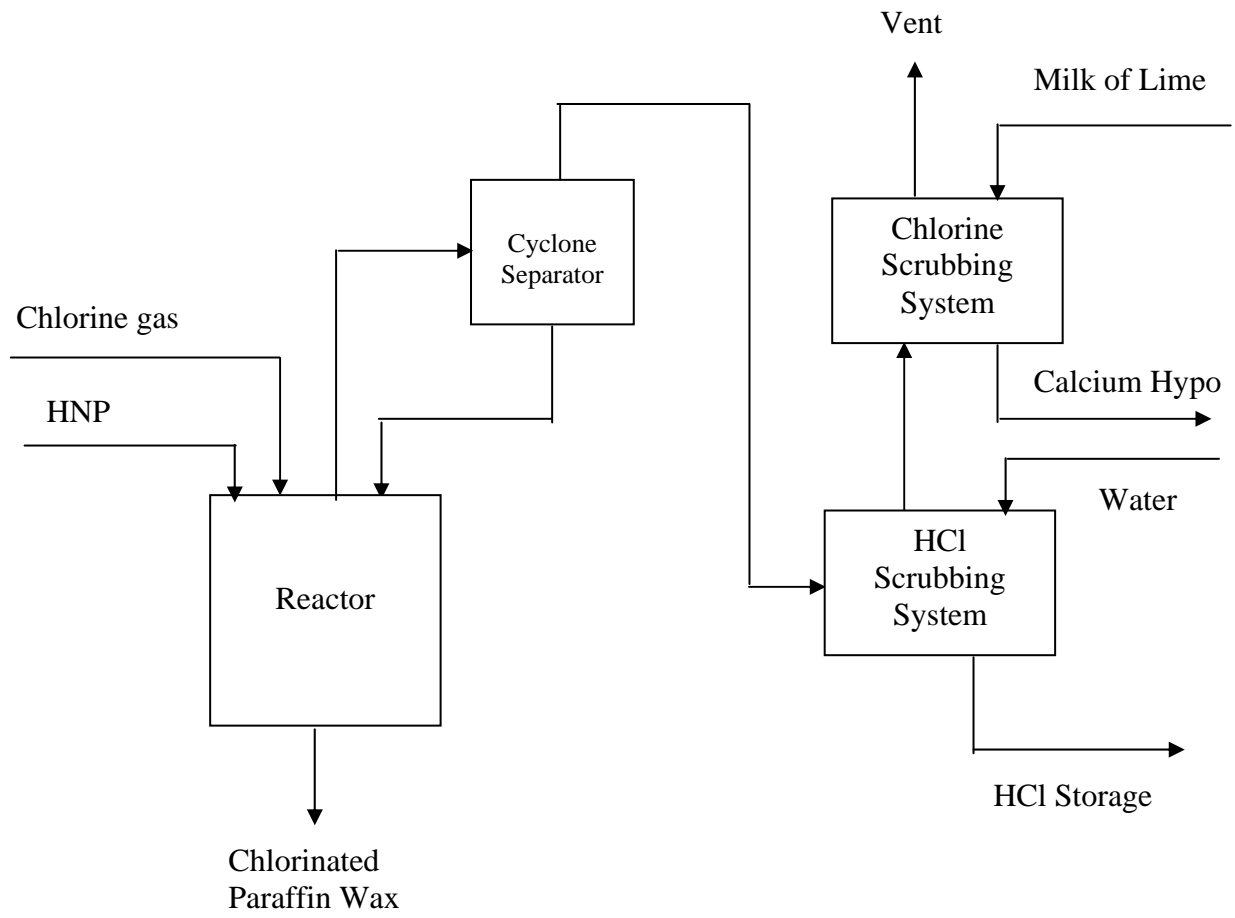

**Fig. 1 : Block Diagram for CPW Production**

## Process description along with model calculation on mass balance of chlorine utilization

### Unit CBW-2

**Process Description :** Heavy Normal Paraffin (HNP) is pre-heated in a melter. After attaining the temperature of 85°C the material is transferred to reactor and chlorine is allowed to pass from the bottom of the reactor. With the progress of reaction, the temperature gradually increases. Ambient temperature is maintained by circulation of cold water in the outside jacket of the reactor and controlling the supply of chlorine. A block diagram for CPW production is depicted in **Fig. 1**.

HNP gradually absorbs chlorine and absorption is more at bottom than at top. With increase of chlorine in reaction vessel, the heavier material at bottom picks up the upper material and boils up. The reaction is a vigorous at this stage and temperature and pressure attain a maximum level. Due to the increase of temperature to about 110°C, the carbon chain of HNP breaks and this is for vigorous reaction. The reaction of chlorine gas with hydrocarbons results in emission of hydrochloric acid gas. The HCl gas is circulated in water with the help of scrubbing system resulting in formation of HCl acid. Thereafter, the reaction is gradual and HNP gradually absorbs chlorine. After achieving the required gravity of material the reaction is stopped and material is transferred in storage tank. The material is now ready for packing and despatch.

**Mass Balance of Chlorine Utilisation :** The model calculation on mass balance of chlorine utilisation for the year 2000-01 is presented as under :

#### **Theoretical (2000-01)**

Theoretically, 1.05 T of chlorine required per Tonne of CPW production

Chlorine consumed for CPW production = chlorine consumption norm x CPW production

Chlorine consumption for 1288.5 T of CPW = 1.05 x 1288.5 = 1352.92 T

Actual chlorine consumed to produce 1288.5 T of CPW = 1439.1 T

Difference between theoretical and actual chlorine consumption (T)

= Actual chlorine consumed - theoretical chlorine required

= 1439.1 - 1352.92 = 86.18 T

86.18 T of excess chlorine is utilised than the theoretical consumption norm.

1439.1 T of chlorine utilised to produce 1288.5 T of CPW. As per the reaction, 0.51 T of HCl (100%) could have produced per tonne of CPW.

Theoretical HCl (100%) produced during CPW production =

= Quantity of HCl produced per T of CPW x CPW production

= 0.51 x 1288.5 = 657.13 T

HCl (30%) production = 657.13 x 3.3 = 2168.53 T

Theoretically,

Chlorine utilised for CPW production

$$\begin{aligned} &= \text{CPW production} \times \text{chlorine equivalent per tonne of CPW} \\ &= 1288.5 \times 0.499 = 642.96 \text{ T} \end{aligned}$$

Chlorine utilised for HCl production (30%)

$$\begin{aligned} &= \text{HCl production (30\%)} \times \text{Chlorine eq. per tonne of HCl} \\ &= 2168.53 \times 0.3 = 650.56 \text{ T} \end{aligned}$$

Total chlorine utilised in CPW and HCl production

$$\begin{aligned} &= \text{Chlorine utilised for CPW} + \text{Chlorine utilised for HCl (30\%)} \\ &= 642.96 + 650.56 = 1293.52 \text{ T} \end{aligned}$$

$$\text{Theoretical chlorine unutilised during consumption} = 1352.92 - 1293.52 = 59.4 \text{ T}$$

Total theoretical chlorine loss in 1288.5 T CPW production

$$\begin{aligned} &= \text{Excess chlorine utilised} + \text{chlorine unutilised} \\ &= 86.18 + 59.4 = 145.58 \text{ T} \end{aligned}$$

$$\text{Total chlorine loss (theoretical)} = 145.58 \text{ T}$$

The above quantity does not include handling and process losses to the extent of 5%.

### **Actual Situation in Industry (2000-01)**

Chlorine consumed for CPW production

$$\begin{aligned} &= \text{Chlorine consumption norm} \times \text{CPW production} \\ &= 1.12 \times 1288.5 = 1443.12 \text{ T} \end{aligned}$$

$$\text{Actual HCl produced (30\%)} = 2179.3 \text{ T}$$

Chlorine utilised for CPW production

$$\begin{aligned} &= \text{CPW production} \times \text{chlorine equivalent per tonne of CPW} \\ &= 1288.5 \times 0.499 = 642.96 \text{ T} \end{aligned}$$

$$\begin{aligned} \text{Chlorine utilised for HCl (30\%)} &= \text{HCl production} \times \text{Chlorine eq. per tonne of HCl} \\ &= 2179.3 \times 0.3 = 653.79 \text{ T} \end{aligned}$$

$$\text{Total chlorine utilised for CPW and HCl production} = 642.96 + 653.79 = 1296.75 \text{ T}$$

Total chlorine unreacted / loss in CPW manufacturing process

$$\begin{aligned} &= \text{chlorine consumed} - \text{quantity of chlorine utilised} \\ &= 1439.1 - 1296.75 = 142.35 \text{ T} \end{aligned}$$

$$\text{Total chlorine unreacted / loss in CPW manufacturing process} = 142.35 \text{ T}$$

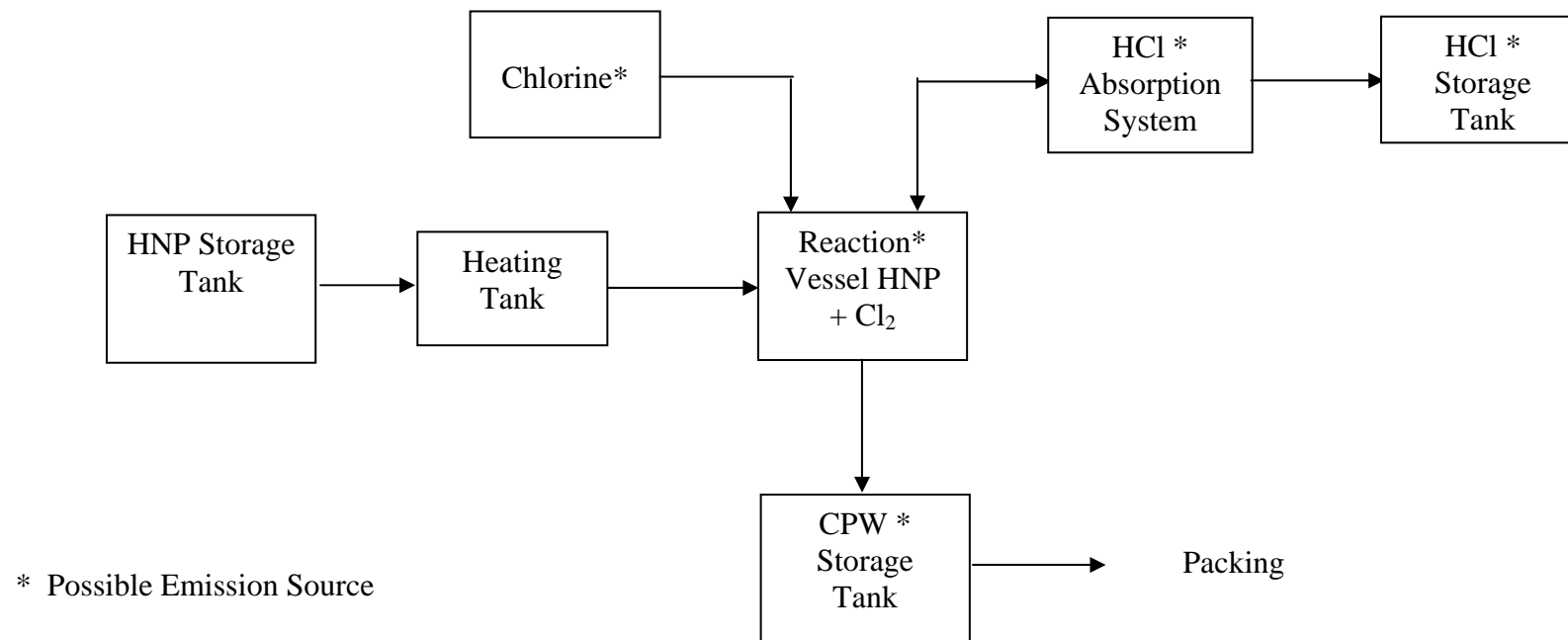

**Fig. 1 : Block Diagram for CPW Manufacturing Process**

## Process description along with model calculation on mass balance of chlorine utilization

### Unit CBW-3

**Process Description :** Heavy Normal Paraffin (HNP) is heated to the required temperature in the heating kettle and then charged into the reactor where chlorine gas is bubbled through it. The flowsheet for CPW manufacturing is depicted in **Fig. 1**. During the reaction (batch process lasting about 40 to 44 hrs) hydrochloric acid gas is formed which is fed into the absorption system along with traces of unreacted chlorine. HCl gas is scrubbed in three stages. The first absorber is co-current, the second absorber is counter-current and the bulk of HCl gas gets converted in to hydrochloric acid in these stages by a continuous recirculation system until the desired concentration of acid is obtained.

The left over gases are then fed into the bubbling tank where all the remaining HCl gas is converted into hydrochloric acid. In the final stage the flue gases (mostly un-reacted chlorine) are sent to the lime tower where lime slurry is being pumped counter-currently to neutralise these unabsorbed gases. To ensure fool-proof safety two lime pumps are installed to overcome the chances of failure of any one of them. Subsequently, the left over gases are fed to the caustic tower where 20% caustic soda lye (solution) is used to neutralise the same by counter-current pumping. Finally any traces of gases still left over are absorbed in a carboy containing 25% caustic soda lye (solution).

After every batch, the product obtained in the reactor is aerated in a separate tank to expel any trapped gases in the product. The CPW is then filled in drums / tanker. The hydrochloric acid produced is pumped to the HCl acid storage tank from where it is filled in tankers.

**Mass Balance of Chlorine Utilisation :** The model calculation on mass balance of chlorine utilisation for the year 2000-01 is presented as under :

### Theoretical

Theoretically, 1.05 T of chlorine required per Tonne of CPW production  
 Chlorine consumed for CPW production = chlorine consumption norm x CPW production  
 Chlorine consumption for 657 T of CPW =  $1.05 \times 657 = 689.85$  T  
 Actual chlorine consumed to produce 657 T of CPW = 740 T

Difference between theoretical and actual chlorine consumption (T)  
 = Actual chlorine consumed - theoretical chlorine required  
 =  $740 - 689.85 = 50.15$  T

50.15 T of excess chlorine is utilised than the theoretical consumption norm.

740 T of chlorine utilised to produce 657 T of CPW. As per the reaction, 0.51 T of HCl (100%) could have produced per tonne of CPW.

Theoretical HCl (100%) produced during CPW production =  
 = Quantity of HCl produced per T of CPW x CPW production  
 =  $0.51 \times 657 = 335.07$  T  
 HCl (30%) production =  $335.07 \times 3.3 = 1105.73$  T

Theoretically,

Chlorine utilised for CPW production  
 = CPW production x chlorine equivalent per tonne of CPW  
 =  $657 \times 0.499 = 327.84$  T

Chlorine utilised for HCl production (30%)  
= HCl production (30%) x Chlorine eq. per tonne of HCl  
= 1105.73 x 0.3 = 331.72 T

Total chlorine utilised in CPW and HCl production  
= Chlorine utilised for CPW + Chlorine utilised for HCl (30%)  
= 327.84 + 331.72 = 659.56 T

Theoretical chlorine unutilised during consumption = 689.85 - 659.56 = 30.29 T

Total theoretical chlorine loss in 657 T CPW production  
= Excess chlorine utilised + chlorine unutilised  
= 50.15 + 30.29 = 80.44 T

Total chlorine loss (theoretical) = 80.44 T

The above quantity does not include handling and process losses to the extent of 5%.

### **Actual Situation in Industry**

Chlorine consumed for CPW production  
= Chlorine consumption norm x CPW production  
= 1.11 x 657 = 729.27 T

Actual HCl produced (30%) = 1157 T

Chlorine utilised for CPW production  
= CPW production x chlorine equivalent per tonne of CPW  
= 657 x 0.499 = 327.84 T

Chlorine utilised for HCl (30%) = HCl production x Chlorine eq. per tonne of HCl  
= 1157 x 0.3 = 347.1 T

Total chlorine utilised for CPW and HCl production = 327.84 + 347.1 = 674.94 T

Total chlorine unreacted / loss in CPW manufacturing process  
= chlorine consumed - quantity of chlorine utilised  
= 740 - 674.94 = 65.06 T

Total chlorine unreacted / loss in CPW manufacturing process = 65.06 T

**Unit CPW-1****Table 4.1: Production of CPW, HCl and Consumption of Chlorine**

| Description | Installed Capacity (T) | Production (T) |         |         |         |         |
|-------------|------------------------|----------------|---------|---------|---------|---------|
|             |                        | 1996-97        | 1997-98 | 1998-99 | 1999-00 | 2000-01 |
| CPW         | 1200                   | 603            | 252     | 1055    | 751     | 612     |
| HCl (30%)   | 2400                   | 1200           | 500     | 2100    | 1500    | 1200    |

| Raw material | Norm T/T of CPW | Consumption (T) |         |         |         |         |
|--------------|-----------------|-----------------|---------|---------|---------|---------|
|              |                 | 1996-97         | 1997-98 | 1998-99 | 1999-00 | 2000-01 |
| Chlorine     | 1.3             | 785             | 330     | 1390    | 938     | 795     |
| Paraffin*    | 0.45            | 270             | 113     | 475     | 337     | 275     |

\* HNP ( $C_nH_{2n+2}$ )

**Summary of Mass Balance of Chlorine Utilisation**

| Description                                  | Quantity (Tonnes) |         |         |         |         |
|--|-------------------|---------|---------|---------|---------|
|  | 1996-97           | 1997-98 | 1998-99 | 1999-00 | 2000-01 |
| CPW production                               | 603               | 252     | 1055    | 751     | 612     |
| Actual chlorine consumed                     | 785               | 330     | 1390    | 938     | 795     |
| Quantity of HCl produced (30%)               | 1200              | 500     | 2100    | 1500    | 1200    |
| Chlorine utilised by CPW                     | 354.56            | 148.2   | 620     | 441.6   | 359.9   |
| Chlorine utilised by HCl (30%)               | 360               | 150     | 630     | 450     | 360     |
| Chlorine unreacted / lost                    | 70.44             | 31.8    | 140     | 46.4    | 75.1    |
| Chlorine loss in terms of Calcium Hypo waste | 54.35             | 22.84   | 95.91   | -       | 54.85   |
| Chlorine vented                              | 16.09             | 8.95    | 44.09   | -       | 20.24   |

Note : Around 2-4% chlorine in each cylinder is returned unused due to high back pressure of chlorine user equipment. This quantity of chlorine is included in chlorine consumption figures provided by the industry. However, unused chlorine from cylinders is not taken into account while calculating the mass balance of chlorine utilisation by the industry.



## Unit CPW-2

**Table 4.2: Production of CPW, HCl and Consumption of Chlorine**

| Description | Production (T) |         |         |         |         |
|-------------|----------------|---------|---------|---------|---------|
|             | 1996-97        | 1997-98 | 1998-99 | 1999-00 | 2000-01 |
| CPW         | 256.50         | 488.25  | 675.00  | 960.29  | 1288.50 |
| HCl (30%)   | 626.80         | 947.80  | 1750.90 | 2062.00 | 2179.30 |

| Raw material | Consumption (T) |         |         |         |         |
|--------------|-----------------|---------|---------|---------|---------|
|              | 1996-97         | 1997-98 | 1998-99 | 1999-00 | 2000-01 |
| Chlorine     | 315.00          | 597.60  | 832.50  | 1107.00 | 1439.10 |
| Paraffin     | 134.28          | 246.02  | 308.00  | 440.00  | 595.31  |

Note : Chlorinated paraffin is manufactured keeping in view of its application, as it's a basic raw material in plastic industry. The specific gravity of CPW is between 1100 and 1400 g/cm<sup>3</sup> and the difference is caused due to mass of chlorine. Therefore, heavy normal paraffin on an average is consumed about 1.25 kg of chlorine per kg of CPW

### **Summary of Mass Balance of Chlorine Utilisation**

| Description                    | Quantity (Tonnes) |         |         |         |         |
|--------------------------------|-------------------|---------|---------|---------|---------|
|                                | 1996-97           | 1997-98 | 1998-99 | 1999-00 | 2000-01 |
| CPW production                 | 256.5             | 488.25  | 675     | 960.29  | 1288.5  |
| HCl production (30%)           | 626.8             | 947.8   | 1750.9  | 2062    | 2179.3  |
| Actual chlorine consumed       | 315               | 597.60  | 832     | 1107    | 1439.1  |
| Chlorine utilised by CPW       | 127.99            | 243.63  | 336.8   | 479.18  | 642.96  |
| Chlorine utilised by HCl (30%) | 188.04            | 284.3   | 315     | 618.6   | 653.79  |
| Total chlorine utilised        | 316               | 527.9   | 651     | 1097    | 1296.75 |
| Unreacted chlorine / loss      | -                 | 69.6    | 180.2   | 10      | 142.35  |
| Total chlorine loss            | -                 | 69.6    | 180.2   | 10      | 142.35  |

Note : Around 2-4% chlorine in each cylinder is returned unused due to high back pressure of chlorine user equipment. This quantity of chlorine is included in chlorine consumption figures provided by the industry. However, unused chlorine from cylinders is not taken into account while calculating the mass balance of chlorine utilisation by the industry.

## Unit CPW-2

**Table 4.3: Production of CPW, HCl and Consumption of Chlorine**

| Description | Installed Capacity (T) | Production (T) |         |         |         |         |
|-------------|------------------------|----------------|---------|---------|---------|---------|
|             |                        | 1996-97        | 1997-98 | 1998-99 | 1999-00 | 2000-01 |
| CPW         | 1100                   | 780            | 578     | 405     | 409     | 657     |
| HCl (30%)   | 2000                   | 1336           | 1028    | 673     | 736     | 1157    |

| Raw material | Norm T/T of CPW | Consumption (T) |         |         |         |         |
|--------------|-----------------|-----------------|---------|---------|---------|---------|
|              |                 | 1996-97         | 1997-98 | 1998-99 | 1999-00 | 2000-01 |
| Chlorine     | 1.11            | 858             | 644     | 452     | 457     | 740     |
| HCl          | 1.75            | 1336            | 1028    | 673     | 736     | 1157    |
| Paraffin*    | 0.48            | 381             | 281     | 197     | 194     | 313     |

\* Straight chain normal paraffins  $C_nH_{2n+2}$  with carbon chain  $C_{13} - C_{14}$

### **Summary of Mass Balance of Chlorine Utilisation**

| Description                    | Quantity (Tonnes) |         |         |         |         |
|--------------------------------|-------------------|---------|---------|---------|---------|
|                                | 1996-97           | 1997-98 | 1998-99 | 1999-00 | 2000-01 |
| CPW production                 | 780               | 578     | 405     | 409     | 657     |
| HCl production (30%)           | 1336              | 1028    | 673     | 736     | 1157    |
| Actual chlorine consumed       | 858               | 644     | 452     | 457     | 740     |
| Chlorine utilised by CPW       | 389.22            | 288.42  | 202.1   | 204.1   | 327.84  |
| Chlorine utilised by HCl (30%) | 400.8             | 308.4   | 201.9   | 220.8   | 347.1   |
| Total chlorine utilised        | 790.02            | 596.82  | 404     | 424.9   | 674.94  |
| Unreacted chlorine / loss      | 67.98             | 47.18   | 48      | 32.1    | 65.06   |
| Total chlorine loss            | 67.98             | 47.18   | 48      | 32.1    | 65.06   |

Note : Around 2-4% chlorine in each cylinder is returned unused due to high back pressure of chlorine user equipment. This quantity of chlorine is included in chlorine consumption figures provided by the industry. However, unused chlorine from cylinders is not taken into account while calculating the mass balance of chlorine utilisation by the industry.

## Pulp & Paper Manufacturing Process

**Raw Material Preparation :** Raw material preparation involves proper sizing of forest based raw materials such as wood or bamboo for subsequent process operations. In case of agricultural residues it involves preparation, cleaning and removal of undesirable components. Wood is chemically very highly complex cellulose is the basic structural component of the cell wall. Lignin and hemicellulose are distributed throughout the cell wall. In addition to cellulose and hemicellulose the wood contains extractives, which includes fats and esters, terpenes and resin acids, phenolic material and tannins. The lignin component binds the cellulose fibre together and these cellulose fibres must be separated from each other before paper processing begin. It may be achieved mechanically or by chemical dissolution of the lignin.

**Pulp Production Process :** Pulping means where the wood is reduced to the fibrous mass for onward processing into paper and board products. There are various methods both mechanical and chemical for pulping. The selection of pulping procedure depends mainly upon the grade of paper being manufactured. Different paper qualities utilise different type of fibres for example in copying paper, hardwood is used as the bulk with softwood fibre added to impart mechanical strength. Newsprint is manufactured predominantly of mechanical or recycled fibres with a small component of soft wood fibre to impart strengthening properties. All pulping processes are designed to separate the wood fibres present in the wood.

Mechanical processes achieve this by grinding or tearing the fibres apart. Chemical processes dissolve the lignin present between the cells allowing the fibres to separate with little or no mechanical action. The major pulp production methods can be categorised as follows :

### Mechanical Pulping

**Groundwood pulping :** These processes essentially grind the raw wood to produce a pulp yield of between 90 and 98% in modern systems. Modifications to the process include the use of steam as a lignin softening agent and carrying out the process under positive pressure. Uses of this pulp are generally restricted to applications such as newsprint, toilet tissues and paperboard since it tends to yellow on age due to the content of residual lignin.

**Refiner mechanical pulping :** This process differs from groundwood pulping principally in the use of chips, wafers and sawmill wastes as feedstock. The dominant process is thermo-mechanical pulp where the wood chips are preheated and steamed before being fed to one of the three standard disc-refiner systems. The resulting pulps are somewhat less bright for a given wood species than groundwood pulps.

**Semi-chemical pulping :** Semi-chemical pulping processes are characterised by a chemical pretreatment stage followed by a mechanical refining step. The process uses predominantly hardwoods and can accommodate wood of relatively inferior quality and wood obtained from mixed stands. The best known of these processes is the neutral sulphite semichemical process and involves impregnation of the chips with sodium sulphite liquor, followed by cooking at 160-190°C and a subsequent disc refining stage. The pulps produced typically have 10-15% residual lignin, much higher than the full chemical pulps. The pulps have high rigidity and stiffness and are used in corrugated boards as well as printing papers, greaseproof papers and bond papers. There is no clear demarcation between the semi-chemical processes and the high yield chemical processes, which are generally modifications of the normal kraft and sulphite pulping methods.

## Chemical pulps

**Alkaline chemical pulping** : The two major alkaline processes for producing chemical pulps are the alkaline sulphate or "kraft" process and the soda process. In both these processes wood chips are cooked with sodium hydroxide in order to dissolve the lignin which binds the fibres together. Sodium sulphide is an additional component of the pulping chemical mix in the kraft process. Both processes are named according to the regeneration chemicals used to compensate for sodium hydroxide, sodium sulphate and sodium carbonate. The kraft process is not only the dominant chemical pulping process but also the most important in terms of the various production methods. The soda process is important largely in the production of non-wood pulps. Various modifications to the kraft and soda processes have been devised in order to attempt to overcome low pulp yields and environmental problems. These generally involve the addition of chemicals to the digest liquor. The most important of these is anthraquinone (AQ). The benefits of AQ pulping include increased delignification rates together with reduced alkali charges and improved pulp properties.

An integral and economically vital part of alkaline pulping mill operations is the regeneration of the cooking liquors. The recovery cycle is well defined for the kraft process and is designed to recover pulping chemicals, reduce water pollution by combusting organic matter in the spent liquor, generate process heat and recover by-products of value. The main steps in the process are the evaporation of the black liquor drained from the digester after wood chip digestion, combustion of the concentrated liquor to produce a mineral "smelt", causticisation of the smelt and regeneration of the lime used in the process. The energy content of the black liquor is high. During the manufacture of chemical pulp, half of the wood is dissolved, and this, when combusted in the recovery boiler, provides heat for the plant systems.

In the recovery boiler, the organic content is combusted to produce heat. Carbon dioxide reacts with sodium hydroxide to produce sodium carbonate. The added sodium sulphate is reduced to sodium sulphide and hence the solid smelt produced by the boiler contains largely sodium carbonate and sodium sulphide. This is dissolved in a tank to produce the green liquor, which is subsequently filtered and treated with calcium hydroxide (slaked lime) to convert the sodium carbonate to sodium hydroxide. The resulting white liquor is then returned to the digestion process. The lime is regenerated by heating and mixing with water removed from the green liquor. This process is, therefore, theoretically closed in relation to water use but not with respect to atmospheric emissions, spills and condensate generation.

The pulps produced by the kraft process are characterised by good strength properties. They are, therefore, the preferred grades in strong paper grades such as the liner in corrugating boards or bag and wrapping papers. Hardwood kraft pulps are used in many printing papers for bulking purposes, in mixture with softwood pulps. The residual lignin present in the pulp is expressed in terms of the "kappa number" which is determined by the oxidation of lignin by potassium permanganate under acidic conditions. The lower the kappa numbers of a pulp, the lower the level of residual lignin. Mostly kraft process is extensively followed all over India for the manufacture of pulp.

**Organosolve Pulping** : Solvent pulping has a number of potential advantages over conventional pulping due to its relatively low charges and chemical consumption coupled with low capita cost and low environmental impact. Aqueous organic solvents such as methanol and ethanol are used for delignification to produce a bleachable pulp, which can be bleached with non-chlorine chemicals. Organosolve pulping method has been receiving increased attention in recent years.

**Pulp Washing, Cleaning & Screening** : Pulp washing, screening and cleaning are carried out to remove black liquor and non-desirable impurities from the pulp with the help of rotary vacuum filters. Rotary screens and various types of centri-cleaners are subsequently employed for removing dirt and sand.

**Bleaching** : The whiteness of produced pulp has traditionally been regarded as an index of quality. The unbleached pulp produced from various pulping processes exhibit a wide range of brightness due to the presence of residual lignin. The pulp produced in kraft process is generally dark brown in colour. The principal aim of pulp bleaching is to increase the brightness of the pulp. The chromophoric components in the pulp are predominantly functional groups of degraded and altered residual lignin, which is darker and more tightly bound to the fibres than the original lignin component. This can either be converted or stabilised or removed by bleaching which is a part of the refining process and produce pure pulp with high alpha-cellulose content. It removes the wood extractives and bark specks conferring superior strength characteristics.

**Bleaching Agents & Processes** : Chemicals used in various sequences for bleaching are chlorine, caustic and oxidising agents, viz. hypochlorites, chlorine dioxide, peroxides and ozone. Commonly used chemicals along with identified key words are depicted below :

C - Chlorination  
H - Hypochlorite  
D - Chlorine dioxide  
Z - Ozone

E - Alkali extraction  
O - Oxygen  
P - Peroxide

Mechanical pulps are bleached using oxidative chemicals like hydrogen peroxide. Hypochlorite was introduced for bleaching at the end of 19<sup>th</sup> century followed by elemental chlorine. A combination of these chemicals along with an intermediate alkaline lignin extraction is also used in some places.

The chemical pulp is generally bleached using a multistage process of three to six steps. The number of steps depends on the pulp characteristics. Hardwood pulp generally requires less bleaching than softwood pulp. Sulphite and bisulphite pulp is easier to bleach than kraft pulp.

In most commercial bleaching processes, chlorine bleaching is the first step carried out with 3-4% chlorine at 20-40°C for 30-60 minutes. During bleaching the residual lignin is converted to water and alkali-soluble degradation products. This step is followed by an alkali extraction process to remove these degradation components. The final stage involves the use of hypochlorite and chlorine dioxide. The use of chlorine dioxide is increasing nowadays for its higher pulp brightness, improved fibre strength properties and considerably less requirements than chlorine.

In most of the Indian mills bleachable grades of pulps of 20-27 Kappa number is produced from Bamboo and Wood while still lower Kappa number below 15 is being kept for Bagasse pulp. The pulps are bleached under C/E/H or C/E/H/H sequence to a brightness level around 80% for most of the end uses. Little doses of hydrogen peroxide in alkali extraction or/and in final bleaching state is used in some of the mills for further enhancement of brightness while a few others utilise chlorine dioxide in the final stage of bleaching to improve pulp brightness and pulp quality. Recently some of the mills have adopted C/D-E/O-H-D, C/D-E/O-P-C, C-E-D-E-D bleaching sequence.

Typical requirement of bleaching chemicals under C-E-H & C-E-H-H sequence for various raw materials in India is presented in **Table 1**. It may be seen that bamboo needs higher percentage of chlorine as compared to Eucalyptus and mixed hardwoods for attaining a pulp brightness of 78-82%, while non-conventional raw materials like Wheat Straw needs higher chlorine consumption than bagasse and Rice Straw under C-E-H sequence.

**Table 1: Typical Requirements of Bleaching Chemicals under C-E-H & C-E-H-H Sequence for Conventional and Non-conventional Raw Material Pulps (Pulp Brightness 78-82%)**

| Description                                       | Bamboo  | Eucalyptus | Mixed hardwood | Bagasse        | Wheat Straw | Rice Straw |
|---|---------|------------|----------------|----------------|-------------|------------|
| Kappa No.   | 18-26   | 19-27      | 22-28          | 10 to 12-15    | 11-13       | 10.4       |
| Chlorine (%)                                      | 3.5-6.0 | 3.0-4.5    | 3.0-4.5        | 1.7 to 2.0-3.0 | 6-7         | 4.0        |
| Sodium Hydroxide (%)                              | 1.5-2.5 | 1.0-2.0    | 1.0-2.0        | 1.0-1.5        | 1.5-1.6     | 1.2        |
| Calcium hypochlorite (% as available chlorine)    | 2.5-3.0 | 2.0-3.0    | 2.5-3.5        | 0.4 to 0.6-1.5 | 3.2-3.8 *   | 1.0        |
| Buffer (%)  | 0.7-0.9 | 0.7-0.9    | 0.7-0.9        | 0.3            | -           | -          |
| Total bleaching chemicals used (Kg/tonne of Pulp) |         |            |                |                |             |            |
| Chlorine  | 60-90   | 50-75      | 55-80          | 20 to 26-45    | 92-108      | 50         |
| Sodium hydroxide                                  | 22-34   | 17-29      | 17-29          | 10 to 14-18    | 15-16       | 72         |

\*including 1.5-1.8% added in caustic stage

### Process Modification for Minimisation of Organochlorine Production

Pulping is the process by which wood is reduced to fibrous mass for onward process into paper and board products. During pulping, the lignin component gets separated from cellulose fibres. The quality of the pulp produce depends upon the raw material and pulping process used. In order to reduce the effluent load the improvement in pulping and bleaching process is necessary. The technologies developed to improve the pulp quality are :

- Continuous pulping
- Extended delignification (Oxygen- alkali digestion, RDH, Superbatch etc.)
- Organosolve pulping (Organocell, alcell, ASAM etc.)
- Peroxyacid pulping (Milox process etc.)
- Enzymes pulping
- Urea pulping

**Continuous pulping process :** Continuous digesters are more energy efficient as compared to batch digesters. They require about 40 to 50% less steam and give 2% higher concentration of black liquor solids. Open structured fibrous raw materials like agro residues are bulky and require less cooking time. Tubular continuous digesters are quite advantageous and are comparatively simple in construction and operation.

**RDH Pulping :** Rapid Displacement Heating (RDH) is a most modern and energy efficient pulping technology. In RDH hot spent cooking liquor are displaced from the stationary digester at the end of the cook by the use of washer filtrate. The pulp is washed and cooked below the flash point. Hot displaced liquors are stored in accumulators and recycled to subsequent cooks to pre-heat the chips and white liquors. The cooked mass / washed pulp is blown from the digester to the blow tank using compressed air.

Compared to conventional cooking, RDH pulping has shown that the digester steam consumption can be reduced by 60 to 75% with improved pulp qualities. Cooking liquor displacement in digester contributes to low washing losses. The gaseous sulphur emission from the blow tank reduces by 90%.

RDH sulfidity is higher through out the cook compared to the conventional cook. Lignin is thus thoroughly sulfidated and ready to disintegrate when reached by alkali and temperatures. In addition to energy saving there are so many other advantages of the process.

- A substantial energy saving with improved pulp quality
- Insensitive to changes in alkali demand
- 60 to 75% reduction in digester steam demand
- Low emission of odour from blow tank
- High sulfidity during impregnation and heat up
- Pressure impregnation
- Pulp is not subjected to a hot blow
- No steam relies from blow tank and hence no mechanical degradation during blow
- Most of the black liquor is removed from the digester and does not reach to brown stock washer / washing prior to BS washer.

**Urea pulping :** Urea pulping is an alternate process to replace the sodium hydroxide for producing few varieties of unbleached grade paper and boards. Unbleached paper of around 28-burst factor could be produced by using 15% urea, which can be used for superior quality linerboard. The process is having an added advantage of using its pulping effluent for irrigation purpose, which is sodium free and rich in nitrogen content.

The second major area of process measures to reduce organochlorine generation is modification in bleaching process. Most organochlorines formed in bleached plant are due to the action of molecular chlorine. Elimination of its use will significantly reduce this formation.

**Improved Bleaching Processes :** The pre-bleaching treatment results in reduction of pulp kappa before bleaching. It reduces bleach chemical demand and thus produces less effluent. The improved bleaching process involve :

- Enzymatic pretreatment of pulp
- Oxygen pre-bleaching of pulp
- Alkaline leaching in presence of hydrogen peroxides
- Alkaline leaching using sodium hydroxide

**Enzymatic pretreatment of pulp :** Enzymatic Pre-bleaching of the pulp reduce bleach chemical demand and effluent load generated during bleaching. Enzymatic pretreatment of the pulp before bleaching provides a very simple and cost effective way to reduce the use of chlorine and chlorine based bleaching chemicals such as calcium hypochlorite, along with higher brightness of the finally bleached pulp. The benefit of the enzymatic pretreatment depends on the chemical bleaching sequence as well as the residual lignin content i.e. number. It results in reduction of about 20% total chlorine and about 15% reduction in the chloro-organics generation during bleaching. Enzymatic treatment is not widely commercialised and still it is at developing stage.

**Oxygen pre-bleaching of pulp :** Oxygen pre-bleaching of the pulp is well established in many countries. Single stage oxygen pre-bleaching of the pulp reduces the pulp kappa by 50-60% and two-stage oxygen pre-bleaching reduces by 80%. Accordingly, various bleaching chemicals used after oxygen delignification in the subsequent stages of bleaching like chlorine, hypochlorite, and hydrogen peroxide also reduced drastically in addition to improved pulp qualities and reduction in AOX. Saving of bleaching chemicals like chlorine, hypochlorite and reduction in AOX level drastically are the indirect saving of energy.

Studies were carried out at CPPRI, Saharanpur on the oxygen pre-bleaching of the pulps of widely used raw materials followed by conventional CEH bleaching. The unbleached pulp from conventionally used raw materials like bagasse, bamboo and eucalyptus of around 15-19 kappa were produced. These pulps were further treated by oxygen to reduce the pulp kappa of different pulps and further bleached by conventional CEH bleaching and also by D/CE/HD & DE/HD sequences to the required brightness level of around 80% ISO. Oxygen pretreatment reduced the pulp kappa to 50-60% and further conventional CEH bleaching of pulps of all the three raw materials could reduce the bleach chemicals consumption and pollution load of the effluent. The concentration of BOD, COD and AOX after secondary treatment ranged 6-24 mg/L, 77-139 mg/L (considering bleach plant effluent volume 100 m<sup>3</sup>/t) and 0.6-0.84 kg/t paper respectively. These values are very well within permissible tolerance limits of Central Pollution Control Board.

For economical reasons there is need for developing simplified procedures for oxygen delignification since the scale of operations in the Indian pulp & paper industry are far below international norms. Cooperation between machine manufacturers and technologists is needed for developing cost-effective system mainly from capital investment point of view.

**Post digester leaching of pulps :** Because of poor solubility of oxygen in water, thorough mixing of oxygen with the pulp during pretreatment is very essential. However, post digester leaching of pulp by alkali, with and without the use of hydrogen peroxide, does not require thorough mixing, during bleaching. Initial mixing of hydrogen peroxide along with alkali is sufficient for the operation.



Keeping in view, the detailed studies were undertaken at CPPRI, Saharanpur to leach the pulps of different raw material with alkali, with and without the use of hydrogen peroxide, followed by the conventional CEH bleaching of the different pulps.

Unbleached pulps of different raw materials were leached with sodium hydroxide (2 - 2.5%), with and without the use of different dosage of hydrogen peroxide. Pulps were further bleached by conventional CEH bleaching sequence to the required brightness level of around + 80% ISO. Alkali leached pulps under optimum conditions resulted a kappa reduction of 25 - 37%, which further resulted drastic reduction in the chlorine and chlorine based chemical (22 - 44% total chlorine) as well as in the effluent load i.e. chloro-organics generated during bleaching (30 - 40% AOX). Use of hydrogen peroxide (0.25%) along with sodium hydroxide was an added advantage mainly in reducing post colour number and further reduction in total chlorine demand in bleaching. Post digester leaching can easily be implemented in the existing mills without much investment. The sodium hydroxide used in leaching along with the organics can be sent to recovery without further diluting the black liquor going back to recovery. In addition to the indirect saving of energy through the reduction of bleach chemical demand and effluent load reduction, the organics going to the chemical recovery is an added advantage of post digester leaching.

### Process Description of the paper mill identified for detailed study

The paper mill started its production in 1965 and has a capacity of 220 T paper production per day. Presently they are manufacturing approximately 200 T/day which include writing, printing, tissue paper and board paper. The process of paper manufacture involves chipping, digestion, washing and screening, bleaching and papermaking. The schematic flow diagram for the production of paper by Kraft process is presented in **Fig. 1**.

**Chipping** : Bamboo along with hard wood is fed to drum chippers through water flume lines for chipping. The bamboo and hardwoods are chipped in Drum Chipper to the size 35-50 mm length and 5-10 mm thickness. The screened chips are sent to silo through conveyor belt and then to digester.

**Digestion** : The digestion of the chips is carried out by Kraft process using sodium sulphide and sodium hydroxide in two stages. In the process, the lignin from bamboo and wood pulp is separated in the form of sodium lignate.

**Washing & Screening** : The resultant brown pulp is washed in rotary drum washers to remove the spent black liquor from the pulp. These washers are run in cascading system for effective washing as well as to obtain maximum possible concentrated black liquor. The black liquor is sent to soda recovery plant for further processing and recovery of cooking chemicals. The washed pulp is screened in centri screens and passed through centri cleaner to remove dirt, shives etc.

**Bleaching Plant** : The bleaching of washed pulp is carried out by CEH process where the pulp is first treated with chlorine gas. It is then treated with caustic solution to extract chloro lignins and to neutralise the effect of chlorine. It is further treated with calcium hypochlorite to get bleached pulp. The CEH bleaching sequence is upgraded to CEHD sequence where chlorine dioxide is used after hypochlorite treatment to increase pulp brightness, improve pulp quality and decrease chlorolignin pollutants and colour. Flow diagram for sequence of bleaching operations is presented in **Fig. 2**. The chlorine required for bleaching is procured and stored in 40 MT tank and sent through pipeline to the bleaching plant. The chlorine demand for the pulp is calculated from the permanganate number test, which is carried out hourly. Depending upon the pulp quality, the dose of chlorine required for pulp bleaching varies between 6 and 8%. As per the information provided by plant incharge the residual chlorine in the generated effluent varies from 15-20 ppm, 10-15 ppm and 5-10 ppm from chlorine bleaching, hypochlorite and chlorine dioxide plant respectively. In bleaching plant there is a control alarm system for chlorine concentration of 2.0 mg/L. Tolerable smell of chlorine was observed near the vents on effluent discharge line. The hypochlorite solution is supplied by M/s Hukumchand Jute Mill through pipeline is stored. It is subsequently sent to the bleaching plant through pipeline. The slurry settled in the settler of hypochlorite solution is sent to ETP and utilised in decolouration of effluent. The chlorine dioxide required is manufactured by Orient Paper Mill by R2 process.

**Paper Making** : The bleached pulp sent to paper machine is processed through refiners to make the fibres suitable for formation of sheet on paper machine. Certain chemicals such as alum and rosin for sizing of paper and talcum powder are added as filler. The blended pulp stock after cleaning and screening is pumped to the paper machine, where paper sheet is formed on an endless wire, and the excess water is removed by various means such as vacuum boxes, presses and dryers. After the dryers the paper passes through calenders to give smooth finish and then reeled. It is further processed and made into reels or sheets as per market requirement.

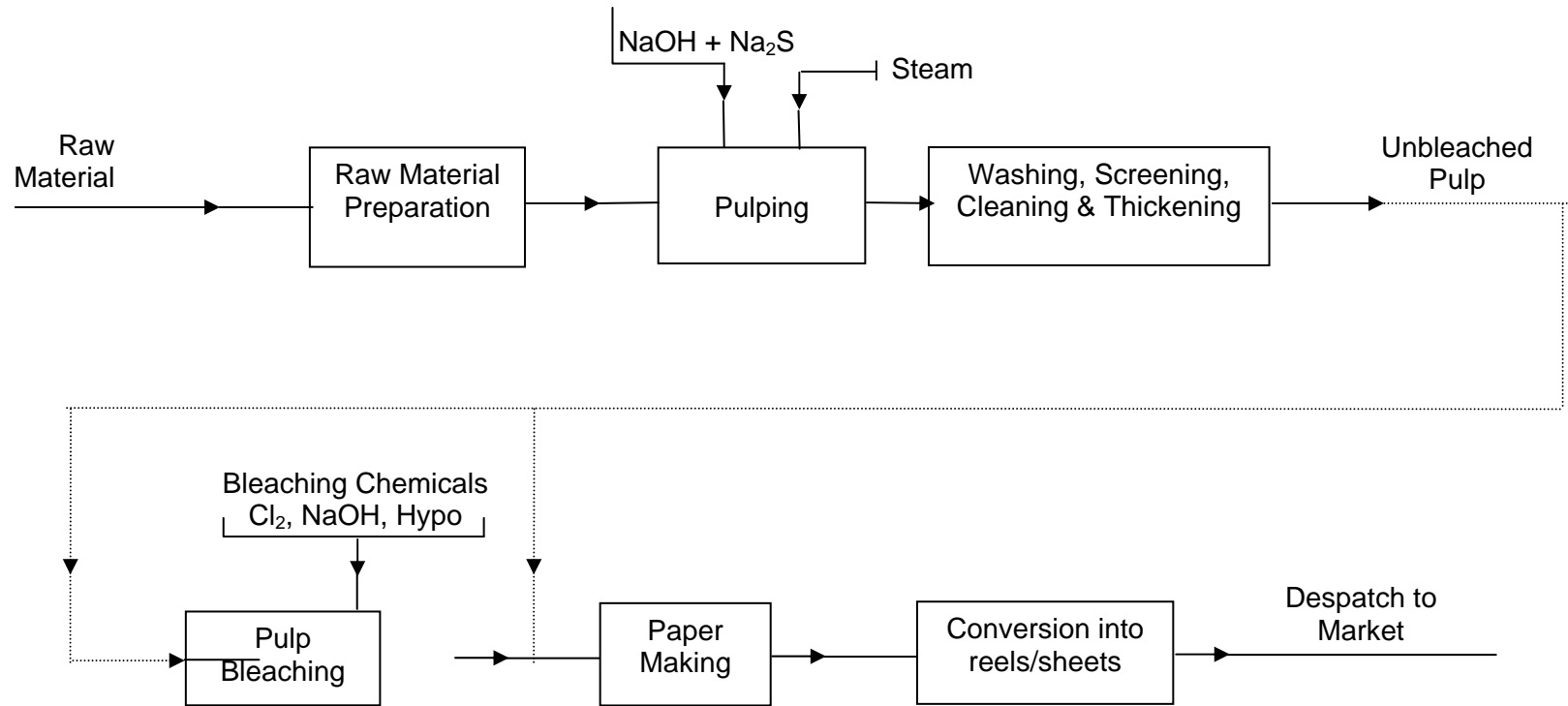

**Fig. 1 : Unit Operations in Pulp & Paper Industry**

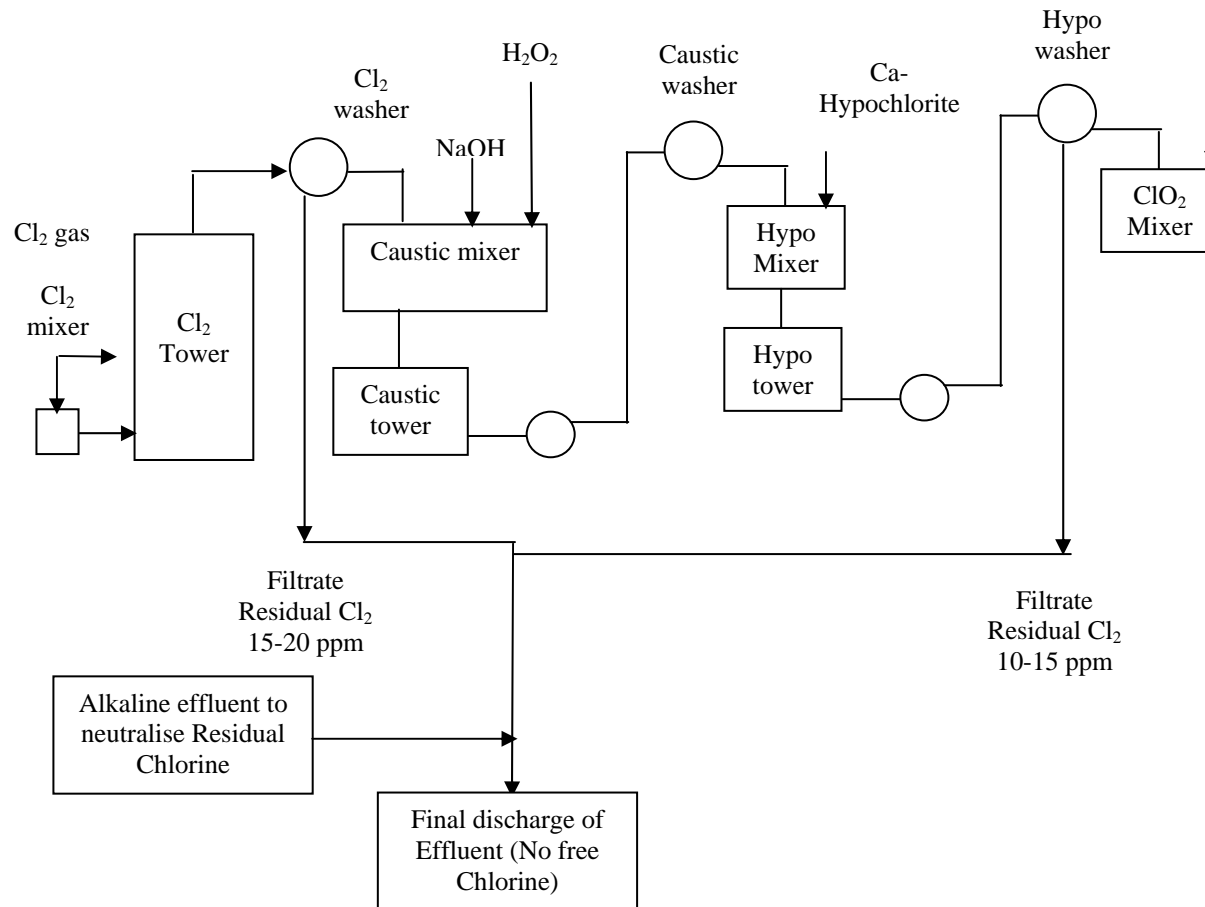

**Fig. 2 : Flow Diagram of Bleach Plant in a paper industry**

### Process Description and Mass Balance in a Chloro-organic Compound Industry

The industry unit produces caustic soda, chlorine (liquid & gas), hydrogen, hydrochloric acid, sodium hypochlorite, hydrogen peroxide, caustic soda flakes, potassium hydroxide, potassium carbonate, sodium cyanide, sodium ferro-cyanide and mixed chloromethanes. The chloromethane plant utilises 30-40% chlorine produced in GACL, Vadodara.

The chloromethane plant is producing mixed chloromethanes, viz. methyl chloride (CH<sub>3</sub>Cl), methylene chloride (CH<sub>2</sub>Cl<sub>2</sub>), chloroform (CHCl<sub>3</sub>) and carbon tetrachloride (CCl<sub>4</sub>). For convenience they are referred as C1, C2, C3 and C4 respectively. In chloromethanes production, hydrochloric acid is also produced as byproduct. The flow diagram of chloromethane manufacturing process is depicted in **Fig. 1**.

**Process Description :** The chemical reactions involved in chloromethane manufacturing is described as follows :

#### Chemical Reactions

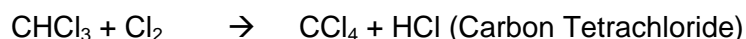
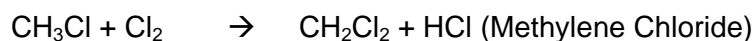
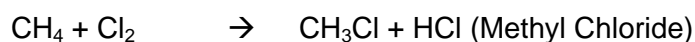

These reactions are free radical chain and exothermic in nature. The unit operations involved in the process are as follows:

- Thermal chlorination
- HCl removal
- Gas treatment
- Gas compression & liquification
- Pure gas treatment
- Distillation
- Photo-chlorination & neutralisation
- Product storage & handling

**Thermal Chlorination :** Methane is reacted with chlorine at high temperature of around 410°C. The reaction being exothermic, only a part of heat is supplied by burning methane (CH<sub>4</sub>) or purge gas as fuel.

Before entering the reactors, recycle gas, methane and chlorine are thoroughly mixed in the specially designed mixer to avoid risk of explosion. The ratio of total chlorine is maintained in such a way that methane / chlorine cannot form explosive mixture. The reactor discharge mainly consists of unreacted CH<sub>4</sub>, mixed chloromethane, HCl gas and inert gases. It is cooled to around 40°C in water coolers.

**HCl Removal :** HCl (32%) is formed by absorbing HCl gas in water in three steps. Final concentration is achieved in four numbers of graphite absorbers. This HCl contains some dissolved / entrained chloromethanes. They are removed from HCl with the help of air

strippings and chloromethanes, free HCl is sent to the storage tanks. The air carries some HCl vapours also alongwith chloromethanes, which is removed by absorption in fresh water.

**Gas Treatment :** Reactor discharge gas after HCl absorption are passed through a series of six columns. In first column residual HCl gas is removed by absorption in dilute HCl. In second column traces of HCl / Chlorine are neutralised with NaOH (18%) solution. The gas is dehumidified in third column with NaOH (18%) solution at 10 to 12°C. The gas is dried in remaining three columns with H<sub>2</sub>SO<sub>4</sub> (98%) flowing in counter- current direction.

**Gas Compression and Liquifications :** The gas is compressed in two horizontal reciprocating double stage, double action compressors to 7 kg/cm<sup>2</sup> and is cooled to about - 10°C in a series of coolers to liquify all chloromethanes. Most of the uncondensed gas is recycled back to the reactors and a part of it is withdrawn as purge gas to maintain inert gas / oxygen concentration in recycle gas.

**Purge Gas Treatment :** Uncondensed chloromethanes are removed from the gas in this section. C1, C2 & C3 are absorbed in C4 in the packed column. The residual C4 going with gas is removed in columns packed with activated carbon. After this treatment the gas mainly consist of methane and inert gases which can be burned as fuel.

**Distillation :** Mixed chloromethanes in liquid form are separated with the help of distillation in bubble cap type columns. Out of such columns, first two are meant for C1 separation and purification, next two are for C2 and three each for C3 and C4.

**Photo-chlorination & Neutralisation :** This unit is installed to enhance the production capacity for C3 and C4. The reaction is carried out in presence of Ultra Violet light in glass lined reactor in liquid phase. HCl formed during the reaction is stripped off by distillation. Residual chlorine / Hydrochloric acid in chloromethanes is neutralised and washed in specially designed 'U' columns. Moisture is removed with the help of azeotropic distillation and chloromethanes are fed to distillation section for separation.

**Product Handling & Storage :** Methyl chloride (C1) is stored in two vessel (25 m<sup>3</sup>) under 7.5 kg/cm<sup>2</sup> pressure to keep it in liquid form. Each tank is provided with two safety valves, down stream of which connected back to the plant to avoid explosion hazard. The storage area is safe guarded with the help of gas leak detectors, Explosion proof fittings and an elaborate water sprinkling system. C1 is filled in tonners as well as cylinders as per customer's requirement.

Methylene chloride (C2), chloroform (C3) and carbon tetrachloride (C4) are stored in storage tanks. Since C2 is a low boiling (40°C) product, its tanks are kept under slight positive pressure to minimise evaporation losses. C3 is stored at lower temperature or under stabilised conditions to avoid decomposition. C4 is stored in ordinary carbon steel tanks.

Model calculation of chlorine and its mass balance in chloromethane plant for the year 1999-00 is as under :

|  |   |  |
|--|---|--|
| Chloromethane production (CLM)   | = | 23490 MT                                   |
| HCl (30%)  | = | 70470 MT                                   |
| Chlorine required as per norm  | = | Chlorine consumption norm x CLM production |
|  | = | 1.829 x 23490                              |
|  | = | 42963.21 MT                                |
| Actual chlorine consumed   | = | 42986.274 MT                               |
| Difference between actual chlorine consumption and chlorine required as per norm | = | 42986.274 - 42963.21 = 23.064 MT           |

Chlorine utilised for chloromethane (Stoichiometric chlorine consumption per MT of CLM)

$$\begin{aligned}
 &= \text{Chlorine equivalent in CLM} \times \text{CLM production} \\
 &= 0.8884 \times 23490 \\
 &= 20868.5 \text{ MT}
 \end{aligned}$$

Chlorine utilised for HCl (100%) production as a byproduct with CLM (Stoichiometric chlorine consumption per MT of HCl)

$$\begin{aligned}
 &= 0.8884 \times \text{CLM production} \\
 &= 20868.5 \text{ MT}
 \end{aligned}$$

Total chlorine utilised for chloromethane and HCl (100%) = 20868.5+20868.5

$$\begin{aligned}
 &= 41737 \text{ MT}
 \end{aligned}$$

Chlorine unutilised / unreacted (loss) = 42963.21 - 41737 = 1226.21 MT

This unreacted chlorine absorbed in NaOH solution and released in to drain

Total chlorine loss = Difference + unutilised / unreacted chlorine

$$\begin{aligned}
 &= 23.064 + 1226.21 \\
 &= 1249.274 \text{ MT}
 \end{aligned}$$

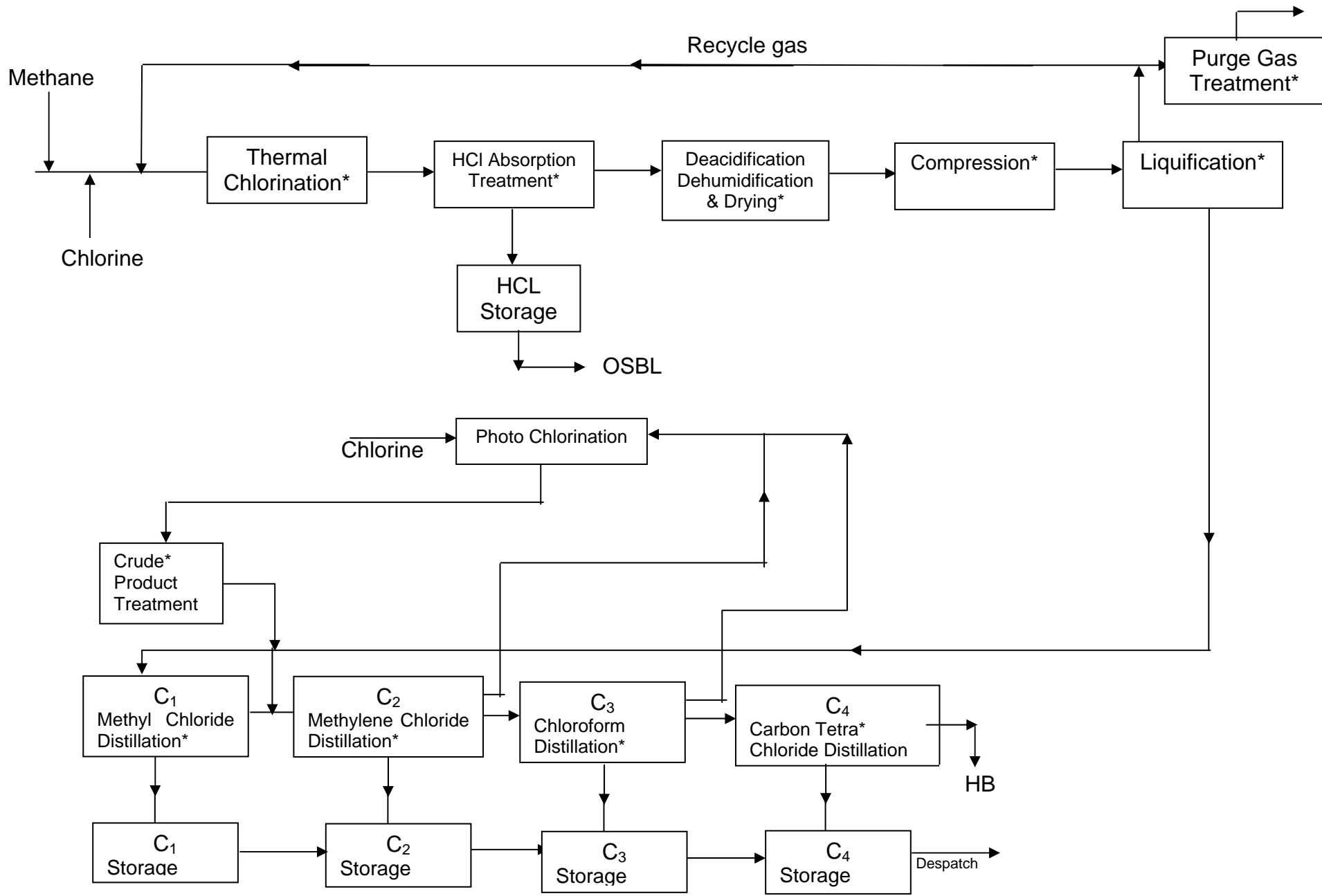

\* Possible Emission Sources

**Fig. 1 : Flow Diagram of Chloromethanes Plant**



### The Dirty Dozen and six other POPs

The Stockholm Convention on Persistent Organic Pollutants identified an initial twelve chemicals or chemical groups for priority action as given below.

#### “The Dirty Dozen POPs” Designated for International Action

| Dirty Dozen POPs  |
|---|
| <p><b>Aldrin:</b> (organochlorine pesticide)<br/>A pesticide applied to soils to kill termites, grasshoppers, corn rootworm, and other insect pests.</p> <p>CAS chemical name: 1,2,3,4,10,10 Hexachloro 1,4,4a,5,8,8a hexahydro 1,4:5,8 dimethanonaphthalene.<br/>CAS No.: 309 00 2; molecular formula: C<sub>12</sub>H<sub>8</sub>Cl<sub>6</sub>; formula weight: 364.92<br/>Appearance: White, odourless crystals when pure; technical grades are tan to dark brown with a mild chemical odour.</p>   |
| <p><b>Chlordane:</b> (organochlorine pesticide)<br/>Used extensively to control termites and as a broad-spectrum insecticide on a range of agricultural crops.</p> <p>CAS Chemical Name: 1,2,4,5,6,7,8,8 octachloro 2,3,3a,4,7,7a hexahydro 4,7 methano 1H indene<br/>Appearance: colourless to yellowish brown viscous liquid with an aromatic, pungent odour similar to chlorine;</p>   |
| <p><b>DDT:</b> (organochlorine pesticide)<br/>DDT was widely used during World War II to protect soldiers and civilians from malaria, typhus, and other diseases spread by insects. Also used as insecticide on agricultural crops, especially cotton. It continues to be applied against mosquitoes in several countries to control malaria.</p> <p>CAS Chemical Name: 1,1' (2,2,2 Trichloroethylidene)bis(4 chlorobenzene)<br/>CAS No.: 50 29 3; molecular formula: C<sub>14</sub>H<sub>9</sub>Cl<sub>5</sub>; formula weight: 354.49.<br/>Appearance: Odourless to slightly fragrant colourless crystals or white powder.</p>                                |
| <p><b>Dieldrin:</b> (organochlorine pesticide)<br/>Used principally to control termites and textile pests, dieldrin has also been used to control insect-borne diseases and insects living in agricultural soils.</p> <p>CAS Chemical Name: 3,4,5,6,9,9 Hexachloro 1a,2,2a,3,6,6a,7,7a octahydro 2,7:3,6 dimetanonaph[2,3 b]oxirene.<br/>CAS No.:60 57 1; molecular formula: C<sub>12</sub>H<sub>8</sub>Cl<sub>6</sub>O; formula weight: 380.91.<br/>Appearance: A stereo isomer of endrin, dieldrin may be present as white crystals or pale tan flakes, odourless to mild chemical odour.</p>   |
| <p><b>Endrin:</b> (organochlorine pesticide)<br/>This insecticide is sprayed on the leaves of crops such as cotton and grains. It is also used to control mice, voles and other rodents.</p> <p>CAS Chemical Name: 3,4,5,6,9,9, Hexachloro 1a,2,2a,3,6,6a,7,7a octahydro 2,7:3,6 dimethanonaphth[2,3 b]oxirene.<br/>CAS No.: 72 20 8; molecular formula: C<sub>12</sub>H<sub>8</sub>Cl<sub>6</sub>O; formula weight: 380.92.<br/>Appearance: White, odourless, crystalline solid when pure; light tan colour with faint chemical odour for technical grade.</p>   |
| <p><b>Heptachlor:</b> (organochlorine pesticide)<br/>Primarily employed to kill soil insects and termites, heptachlor has also been used more widely to kill cotton insects, grasshoppers, other crop pests, and malaria-carrying mosquitoes.</p> <p>Chemical Name: 1,4,5,6,7,8,8-Heptachloro-3a,4,7,7a-tetrahydro-4,7-methanoindene (C<sub>10</sub>H<sub>5</sub>Cl<sub>7</sub>).<br/>CAS Number: 76-44-8<br/>Appearance: It is white crystalline solid and soluble in most organic solvents. The substance has a Camphor-like odor.</p>  |
| <p><b>Hexachlorobenzene (HCB):</b> (organochlorine pesticide and by-product chemical)<br/>Fungicide used for seed treatment of wheat, onions, sorghum. Also found as impurity in several pesticides formulations. An industrial chemical used to make fireworks, ammunition, synthetic rubber. It is also released as a by-product of the manufacture of industrial chemicals including carbon tetra-chloride, perchlorethylene, trichloroethylene and pentachlorobenzene and as a result of the processes that give rise to dioxins and furans.</p> <p>CAS Chemical Name: hexachlorobenzene<br/>Appearance: White monoclinic crystals or crystalline solid</p> |

|  |
|--|
| <p><b>Mirex:</b> (organochlorine pesticide)<br/>This insecticide is applied mainly to combat fire ants and other types of ants, leaf cutters, harvester termites, mealbug and yellow jacket wasps. It has also been used as a fire retardant in plastics, rubber, and electrical goods.</p> <p>CAS chemical name: 1,1a,2,2,3,3a,4,5,5a,5b,6 dodecachloroacta hydro 1,3,4 metheno 1H cyclobuta[cd]pentalene<br/>Appearance: White crystalline, odourless solid;</p>   |
| <p><b>Texaphene:</b> (organochlorine pesticide)<br/>This insecticide, a mixture of more than 670 chemicals, is also called camphechlor and is applied to cotton, cereal grains, fruits, nuts, and vegetables. It has also been used to control ticks and mites in livestock.</p> <p>CAS Chemical Name: Toxaphene<br/>CAS No.: 8001 35 2; molecular formula: C10H10Cl8; formula weight: 413.82<br/>Appearance: Yellow, waxy solid with a chlorine/terpene like odour.</p>   |
| <p><b>Polychlorinated Biphenyls</b><br/>(compounds with varied industrial applications)<br/>These compounds are employed in industry for a variety of industrial applications, including as heat exchange fluids, in electric transformers and capacitors, and as additives in paint, carbonless copy paper, sealants and in plastics as a flame retardant.</p> <p>CAS No.: 1336 36 3</p> <p>In PCBs the presence of Chlorine atoms which attached to biphenyl ring can vary from 2 to 10. PCBs show isomerism. There are a lot of homolog PCB molecules that have different isomeric structures. PCBs are generally inert, they are resistant to alkalies, acids and they have high thermal stability. They are industrially valuable compound used generally in dielectric fluids, transformers, capacitor, lubricants etc.</p>                            |
| <p><b>Dioxins</b><br/>(unintentionally formed compounds)<br/>These chemicals are produced unintentionally due to incomplete combustion, as well as during the manufacture of certain pesticides and other chemicals like polyvinyl chloride, chlorinated solvents and other chlorinated solvents. In addition, certain kinds of metal recycling and pulp and paper bleaching can release dioxins. Dioxins have also been found in automobile exhaust, tobacco smoke and wood and coal smoke.</p> <p>Dioxins are a class of hydrocarbons that contain two oxygen atoms generally attached to the para position of two benzene rings. Chlorinated dioxins are very stable which are less soluble in water and are less volatile. They particulate easily with air, water and soil. They are very toxic.<br/>eg:-Pentachlorodibenzo-p-dioxins (C12H3Cl5O2).</p> |
| <p><b>Furans</b><br/>(unintentionally formed compounds)<br/>These compounds are produced unintentionally from the same processes that release dioxins, and they are also found in commercial mixtures of PCBs.</p> <p>Dibenzofuran contains two benzene rings fused to a central furan ring. Chloro-Dibenzofurans(CDFs) are a class of compounds contain 1 to 8 chlorine atoms attached to the benzene rings of Dibenzofurans. It is nearly insoluble in water, relatively stable towards acids and alkalies and it withstands high temperatures.</p>  |

The UNECE Convention negotiations for a protocol on POPs named following six additional compounds:

|  |
|--|
| <p><b>Hexabromobiphenyl:</b> Hexabromobiphenyl is a flame retardant suitable for use in thermosetting resins and thermoplastics.</p>   |
| <p><b>Pentachlorophenol:</b> Pentachlorophenol has been used as herbicide, insecticide, fungicide, algacide, disinfectant and as an ingredient in antifouling paint. Some applications were in agricultural seeds (for nonfood uses), leather, masonry, wood, cooling tower water, rope and paper mill system.</p> |
| <p><b>Chlordecone:</b> Kepone (also known as Chlordecone) is an insecticide related to mirex used for ant and roach baits.</p>   |
| <p><b>Lindane:</b> Lindane is an insecticide, also known as gamma-hexachlorocyclohexane (HCH) and benzene hexachloride (BHC). It has been used in agriculture and in pharmaceutical products for the treatment of headlice and scabies.</p>  |
| <p><b>Short chain chlorinated parffins</b></p>   |
| <p><b>Polyaromatic hydrocarbons</b></p>  |

## Status of Dirty Dozen POPs' in India

**Aldrin** : Used on crops like corn and to keep away birds. It has since been banned in India.

**Chlordane** : A carcinogenic pesticide widely used to control termites and since has been banned in India.

**Dichlorodiphenyl trichloroethane (DDT)** : Small amounts of DDT are today used on crops; however, DDT is still widely employed as the cheapest means of controlling mosquitoes that carry malaria and other diseases. It is banned in 34 countries including India because of toxicity to mammals, including humans, Global cumulative production of DDT is estimated to be at 1.36 million tonnes.

**Dieldrin** : It is an insecticide with probably the strongest carcinogenic effect amongst all organochlorine pesticides and since has been banned in India.

**Endrin** : Used mainly on field crops such as cotton and grains. Also used as a rodenticide and to keep away birds. It has since been banned in India.

**Heptachlor** : Used in Mexico, Bulgaria and the US to kill insects in seed grains and on crops, and to fight termites. It is now banned in India.

**Hexachlorobenzene (HCB)** : Once widely used as a fungicide to protect seeds, HCB is also released into the environment as a by-product during the manufacture of chlorine gas and some chlorinated pesticides, and during waste incineration. It causes porphyria turcica, a metabolic disorder, and damages reproductive and immune systems.

**Mirex** : Used as an insecticide and fire retardant in the US till 1987 and also known to cause cancer in laboratory animals. It has not been produced and not used in India.

**Toxaphene** : It took over from DDT in 1970s as the world's most popular insecticides, particularly used in cotton-growing. It is now banned in 37 countries including India. A report by the World Wildlife Fund (WWF) claims that toxaphene is still manufactured in China, Nicaragua and Pakistan.

**Polychlorinated biphenyls (PCBs)** : PCBs are the leading industrial POPs. Being chemically stable and heat-resistant, they are widely used in electrical equipment oils such as transformers and capacitors as a heat-exchange fluid, and as a lubricant and plasticiser. Acutely toxic in high concentrations, they damage immune and reproductive systems and cause birth defects. Though only small quantities are now produced, they are still being released into the environment due to the break-up of old electrical equipment.

**Dioxins and furans** : These chlorine based compounds are produced in high-temperature incinerators used for burning organic materials including plastics, as an unwanted by-product in industrial processes ranging from metallurgy to the bleaching of paper, and as a trace contaminant in chlorophenol compounds (such as wood preservatives) and herbicides (such as Agent Orange). They are more potent than PCBs, but the effects are similar.

## Status of Some Other POPs in India

**Hexachlorocyclohexane (HCH)** : This insecticide is widely used on cotton and on locust control. There are three chemical forms of HCH - alpha, beta and gamma. The crude manufactured from, known as technical HCH contains all the three forms. Only gamma-HCH is a useful pesticide, modern manufacturers make a pesticide formulation called lindane, which is exclusively gamma-HCH.

**Endosulfan** : Widely used as an insecticide on many crops, including rice, and to control these flies. About 3 million tonnes of endosulfan is being manufactured every year in Germany, Brazil, India, Israel, Indonesia and South Korea. Change of CCl<sub>4</sub> by toluene in endosulfan production could be environmental relevance of the considered synthesis.

**Pentachlorophenol** : An insecticide mainly used as a timber preservative, especially for power line poles, railway sleepers and fence posts.

## Annexure 9.1

## Plant-wise Chlorine Consumption in Water Treatment Plants

| Sl. No. | Name of Plant & Address   | Capacity MLD              | Chlorine gas (Tonnes) |       |       |       | Liquid chlorine (Tonnes) |        |        |        | Bleaching powder (Tonnes) |       |       |       | Expected Losses (%) |
|---------|---|---------------------------|-----------------------|-------|-------|-------|--------------------------|--------|--------|--------|---------------------------|-------|-------|-------|---------------------|
|         |   |                           | 96-97                 | 97-98 | 98-99 | 99-2K | 96-97                    | 97-98  | 98-99  | 99-2K  | 96-97                     | 97-98 | 98-99 | 99-2K |                     |
| 1.      | Water Treatment Plant Ghoghla Tah-Ghoghla Dist.-Diu.                                  | 4.5                       | 4.5                   | 4.5   | 4.5   | 4.5   | -                        | -      | -      | -      | -                         | -     | -     | -     | 0.25                |
| 2.      | Water Treatment Plant Allahabad city Khushroo Bagh Tah-Sadar, Dist-Allahabad          | 75*<br>60*                | -                     | -     | -     | -     | 36.9                     | 36.9   | 44.5   | 45.0   | 56.9                      | 46.98 | 50.1  | 60.0  | -                   |
| 3.      | Water Treatment Plant Kabrai Town Tah & Dist-Mahoba U.P. Jal Nigam Mahoba (U.P.)      | 3                         | -                     | -     | -     | -     | -                        | -      | -      | -      | 3.5                       | 3.5   | 3.8   | 4.5   | 10.25               |
| 4.      | Nishat Treatment Plant Tah & Dist-Srinagar (J&K)                                      | 68.1                      | -                     | -     | -     | -     | -                        | -      | -      | -      | 20.0                      | 20.0  | 20.0  | 26.0  | -                   |
| 5.      | Doodganga Treatment Plant Kralapora Tah-Chadvra, Dist-Budgam                          | 35.18                     | -                     | -     | -     | -     | -                        | -      | -      | -      | 11.8                      | 11.8  | 12.0  | 12.0  | 25                  |
| 6.      | Water Treatment Plant Alusteng, Tah-Ganderbal Dist-Srinagar                           | 30.872                    | -                     | -     | -     | -     | -                        | -      | -      | -      | 72.0                      | 72.0  | 72.0  | 72.0  | 20                  |
| 7.      | Water Treatment Plant Rangil, Tah-Gangerbad Dist-Srinagar                             | 90.00                     | -                     | -     | -     | -     | -                        | -      | -      | -      | -                         | -     | -     | -     | -                   |
| 8.      | HAL Water Supply Scheme & Lucknow water supply scheme U.P. Jalnigam, Lucknow          | -                         | -                     | -     | -     | -     | -                        | -      | -      | -      | 10.0                      | 10.0  | 10.0  | 10.0  | 11                  |
| 10.     | Benajhabar Treatment Works Nawabgang, PO& Dist Kanpur                                 | 280                       | -                     | -     | -     | -     | 299.7                    | 383.4  | 357.3  | 300.0  | 128.3                     | 97.27 | 78.72 | 85.0  | 10                  |
| 11.     | Water Treatment Plant Bhardap Complex, Tah-Kurla Dist-Mumbai                          | 2100                      | -                     | -     | -     | -     | 1008.3                   | 1153.7 | 1148.8 | 1200.0 | -                         | -     | -     | -     | -                   |
| 12.     | Water Treatment Plant Kisannagar-1, Tah & Dist-Thane                                  | 2100                      | -                     | -     | -     | -     | 925.2                    | 795.5  | 884.6  | 940.0  | -                         | -     | -     | -     | -                   |
| 13.     | Aizawal Water Supply Scheme, phase I, Aizawal, Mizoram                                | 11.00                     | -                     | -     | -     | -     | -                        | -      | -      | -      | 44.2                      | 44.2  | 48.0  | 48.0  | -                   |
| 14.     | Lambe Luie Treatment Plant, Memmiebay, Port Blair , A&N Island                        | 6.30(old)**<br>9.50(nw)** | -                     | -     | -     | -     | -                        | -      | -      | -      | 73                        | 73    | 73    | 75    | 5                   |
| 15.     | Jawahar Sarowar Treatment Unit, Memmiebay, Tah-Port blair, A & N Island, Dist-Andaman | 2.665                     | -                     | -     | -     | -     | -                        | -      | -      | -      | 18                        | 18    | 18    | 18    | 2.5                 |
| 16.     | Garcharma Treatment Unit, P.O. Garcharma , Tah-South Adaman, Dist.-A & N Island       | 1.816                     | -                     | -     | -     | -     | -                        | -      | -      | -      | 18                        | 18    | 18    | 18    | 2.4                 |

| Sl. No. | Name of Plant & Address  | Capacity MLD                | Chlorine gas (Tonnes) |       |       |       | Liquid chlorine (Tonnes) |        |        |        | Bleaching powder (Tonnes) |       |       |       | Expected Losses (%) |
|---------|--|-----------------------------|-----------------------|-------|-------|-------|--------------------------|--------|--------|--------|---------------------------|-------|-------|-------|---------------------|
|         |  |                             | 96-97                 | 97-98 | 98-99 | 99-2K | 96-97                    | 97-98  | 98-99  | 99-2K  | 96-97                     | 97-98 | 98-99 | 99-2K |                     |
| 17.     | Water Works BATHINDA (Punjab), Near Rose Garden, Dist -Bathanda  | 9.08                        | -                     | -     | -     | -     | -                        | -      | -      | -      | 12                        | 14    | 15    | 16    | 5                   |
| 18.     | Water Treatment Plant Water Works Road, Mansa, P.O - Mansa, Tah & Dist - Mansa                                     | 2.5 mgd                     | -                     | -     | -     | -     | -                        | -      | -      | -      | 11.5                      | 11.7  | 12.00 | 12.00 | 4                   |
| 19.     | Budhlada Gaushala Road, PO Budhlada, Tah&Dist-Budhlada   | -                           | -                     | -     | -     | -     | -                        | -      | -      | -      | 2.5                       | 2.5   | 3.00  | 3.00  | 3.5                 |
| 20.     | 1-5 MGD Water Treatment Plant, Water Works, Complex, MAL, P.O. Malout, Tah - Malout Dist. - Muktsar (Panjab)       | 6.81                        | -                     | -     | -     | -     | -                        | -      | -      | -      | 8.40                      | 8.40  | 8.40  | 8.40  | 5                   |
| 21.     | 2.0 + 5.0 MGD Water Treatment Plant Water Works Complex, Abohar, P.O. - Abohar, Tah – Abohar, Dist. - Ferozepur    | 22.7<br>9.08                | 18                    | 18    | 18    | 18    | -                        | -      | -      | -      | 7.20                      | 7.20  | 7.20  | 7.20  | 4                   |
| 22.     | 4.0 MGD Water Treatment Plant Water Works, Complex, Kotkapura, P.O. - Kotkapura, Tah - Kotkapura Dist. - Faridkot  | 18.16                       | -                     | -     | -     | -     | -                        | -      | -      | -      | 14.40                     | 14.40 | 14.40 | 14.40 | 2                   |
| 23.     | L.M.G.D Water Treatment Plant Sharma Store Nangal Town Ship P.O. Nangal, Tah - Anand pur Sahib, Dist. - Roopnagar  | 4.54                        | -                     | -     | 1.2   | 3.6   | -                        | -      | -      | -      | -                         | -     | -     | -     | -                   |
| 24.     | Water Treatment Plant Lehragnga, Water Works, N.A. P.O. Lehragnga Tah - Moonak Dist. - Sangrur                     | 4.54                        | -                     | -     | -     | -     | -                        | -      | -      | -      | 1.0                       | 1.1   | 1.2   | 1.8   | 2                   |
| 25.     | Water Treatment Plant Chandigarh New, 10MGD 15MGD 15 MGD 5 MGD 15 MGD, 118 Acres, Near Sector – 39 West Chandigarh | 227 MLD stand bye<br>68 MLD | 140                   | 140   | 140   | 140   | -                        | -      | -      | -      | 50                        | 50    | 50    | 50    | 0.01                |
| 26.     | Water Treatment Plant Rajpura, Gazipur, P.O. Rajpura, Tah - Rajpura, Dist. - Patiala                               | 28.60                       | -                     | -     | -     | -     | 1.60                     | 2.20   | 1.74   | 2.50   | -                         | -     | -     | -     | -                   |
|         | <b>Total</b>   |                             | 162.5                 | 162.5 | 162.5 | 163.7 | 2676.8                   | 3001.7 | 3081.9 | 3187.5 | 562.7                     | 534.0 | 524.8 | 741.3 | -                   |

\* 75 MLD plant use liquid chlorine and 60 mld plant use Bleaching powder Source : Questionnaire Survey by NEERI