

PROBES/ /2008

DEVELOPMENT OF NATIONAL EMISSION STANDARDS FOR PETROCHEMICAL PLANTS



CENTRAL POLLUTION CONTROL BOARD
(Ministry of Environment & Forests, Govt. of India)
Parivesh Bhawan, East Arjun Nagar
Delhi – 110 032

September 2008



केन्द्रीय प्रदूषण नियंत्रण बोर्ड

(भारत सरकार का संगठन)

पर्यावरण एवं वन मंत्रालय

Central Pollution Control Board

(A Govt. of India Organisation)

Ministry of Environment & Forests

Phone : 22304948/22307233

ज. मो. माऊसकर, भा.प्र.से.

अध्यक्ष

J. M. MAUSKAR, IAS

Chairman

FOREWORD

Petrochemical industry is concerned with the manufacture of various products and comprises multiple processing units at one specific location adopting different technologies, equipments, unit processes and unit operations from the basic feed stock. It leads to generations of a wide spectrum of emission of air pollutants, mainly of volatile organic compounds. Some of these pollutants are toxic and even carcinogenic, while others are responsible for damage to materials. Some pollutants also have potential for photochemical oxidant creation, global warming, ozone depletion or malodour creation. Besides, volatile organic compounds, there is generation of various types of inorganic hazardous air pollutants and conventional air pollutants.

In order to reduce the air emission of these pollutants to an acceptable level, it is necessary to adopt a comprehensive approach considering possible "end of pipe" technologies, thermal destruction, and good engineering practices with due regard to techno-economic feasibility within the frame work of National Environment Policy (NEP), 2006. The salient features of NEP in this regards may be highlighted as follows:

- (a) Risk reduction related to health, ecosystem and manmade assets.
- (b) General availability of required technology and techno-economic feasibility.
- (c) Achievement of the ambient air quality standard for the location concerned.
- (d) Quality as well as quantity of pollutants emitted.

With this backdrop, the Central Pollution Control Board in association with M/s Aditya Environmental Services, Mumbai and M/s Lurgi India Company Private Limited, New Delhi had taken up a study to develop national emission standard for petrochemical manufacturing units -basic and intermediate products. The results of the study, as contained in this report were factored in development of national standards for this sector.

The high quality work done by the Team of Central Pollution Control Board and the associates, M/s Aditya Environmental Services, Mumbai and M/s Lurgi India Company Private Limited, New Delhi need to be appreciated.

We hope that the information contained in this report will be useful to the Regulatory Authorities, Industries and all other concerned.

(J. M. Mauskar)

September 26, 2008

Project Team

1. Sh. P.M. Ansari, Additional Director - Report Finalisation
2. Dr. D.D. Basu, Senior Scientist - Co-ordination, supervision & Preparation of report
3. Sh. Paritosh Kumar, Sr. Env. Engineer - Report processing
4. Sh. Dinabandhu Gouda, Env. Engineer - Data compilation, analysis and Preparation of report
5. Sh. Atul Sharma, JLA - Secretarial assistance
6. M/s. Aditya Environmental Service, Mumbai - Project execution
7. M/s. Lurgi India Private Limited New Delhi - Project execution

CONTENTS

S. No.	Items	Page No.
	List of Contents	<i>i</i>
	List of Figures	<i>vi</i>
	List of Tables	<i>vii</i>
	List of Annexure	<i>viii</i>
	List of Acronyms	<i>ix</i>
1.0	Introduction	1
1.1	Introduction	1
1.2	Classification	1
1.3	Approach for development of emission standards	4
1.4	Methodology	4
2.0	Status of Petrochemical Industry in India	7
2.1	Usage Pattern of Basic Intermediates	10
2.1.1	Ethylene	10
2.1.2	Propylene	10
2.1.3	C4 Fractions – Butylenes / Butadienes	11
2.1.4	Benzene	12
2.1.5	Toluene	13
2.1.6	Xylene	14
2.2	Feed Stock choice	14
2.3	Downstream Petrochemicals	15
2.3.1	Products based on Ethylene	15
2.3.1.1	Ethylene Oxide and Ethylene Glycol	15
2.3.1.2	Ethylene Dichloride / Vinyl Chloride	16
2.3.1.3	Ethyl Benzene / Styrene	16
2.3.2	Propylene based petrochemicals	17
2.3.2.1	Propylene oxide and Propylene Glycol	17
2.3.2.2	Acrylonitrile	17
2.3.2.3	Isopropyl alcohol	17
2.3.2.4	Cumene	17
2.3.2.5	Phenol / Acetone	17
2.3.2.6	Butanol and 2-Ethyl Hexanol	18
2.3.3	Petrochemicals from Benzene	18
2.3.3.1	Cyclohexane and Caprolactum	18
2.3.3.2	Maleic Anhydride	18
2.3.4	Petrochemicals from Toluene	18
2.3.4.1	Toluene diisocyanate	18
2.3.5	Chemicals from Xylene	19
2.3.5.1	Terephthalic acid and Dimethyl Terephthalate	19
2.3.5.2	Phthalic Anhydride	19
2.4	Observations and Findings – Industry survey	19
3.0	Manufacturing Process	21
3.0	Unit Process	21
3.1	Ethylene / Propylene	22
3.2	Butadiene	25

S. No.	Items	Page No.
3.3	Ethylene Oxide	27
3.4	Ethylene Glycol	30
3.5	EDC & VCM	32
3.6	Propylene Oxide / Propylene Glycol	35
3.7	Isopropyl Alcohol	36
3.8	Acrylonitrile	36
3.9	Benzene and Toluene	39
3.9.1	Manufacture of Benzene and Toluene from pyrolysis gasoline	39
3.9.2	Toluene dealkylation and Toluene disproportionation process	44
3.10	Xylene	48
3.10.1	Xylene manufacture by Naphtha reforming	48
3.10.2	Xylene production from pyrolysis gasoline	54
3.11	Maleic Anhydride	54
3.12	Phenol / Acetone / Cumene	55
3.12.1	Cumene from Benzene and Propylene	55
3.12.2	Phenol from Cumene by peroxidation	55
3.13	Toluene Diisocyanate	57
3.14	Phthalic Anhydride	59
3.15	Dimethyl Terephthalate	61
4.0	Emission Sources in Petrochemical Plants	64
4.0	Common emission sources	64
4.1	Emission from combustion sources (power and steam generation)	64
4.2	Emission profile from olefin complex	65
4.2.1	Plant boundary definition and the degree of integration	65
4.2.2	Emission related to feed stock	67
4.2.3	Scale of operations	67
4.2.4	Plant age	68
4.2.5	Air emission / emission factors and inventory	68
4.3	Emission from cracker furnace (steady state operation)	68
4.3.1	Emission from cracker furnace (de-coke operation)	70
4.3.2	VOC from cracking process	71
4.3.3	Emission inventory from olefin complex	72
4.4	Emission from aromatic plants	72
4.4.1	Volatile organic compounds from aromatic plants	73
4.5	Emission from butadiene plants	74
4.5.1	Process vent	75
4.5.2	Fugitive emissions	75
4.6	Emission from xylene plants	76
4.7	Emission from ethylene oxide and ethylene glycol plant	77
4.8	Emission from EDC and VCM plants	80
4.9	Emission from acrylonitrile	83
4.10	Emission from phthalic anhydride	87
4.11	Emission dimethyl terephthalate	88
4.12	Emission due to transfer operations	88

S. No.	Items	Page No.
	4.12.1 Emission during tanker loading	89
4.13	Storage emission	91
	4.13.1 Storage emission from ethylene and propylene plant	91
	4.13.2 Storage emission from butadiene	92
	4.13.3 Storage emission from benzene plants	92
	4.13.3.1 Monitoring of emission from benzene storage tanks	93
	4.13.4 Storage emission from EO	94
	4.13.5 Storage emission from EDC	94
	4.13.6 Storage emission from ACN	95
	4.13.7 Storage emission from xylene	96
	4.13.8 Storage emission from DMT	96
	4.13.9 Fixed roof storage vessel	96
	4.13.10 Floating roof storage vessel	97
	4.13.10.1 External floating roof (EFR) vessel	97
	4.13.10.2 Internal floating roof (IFR) vessel	98
	4.13.10.3 Emission from floating rook tanks	98
4.14	Flares	99
	4.14.1 Flare from cracker furnace	99
4.15	Fugitive emission	100
	4.15.1 Estimating fugitive emission	103
5.0	Categorisation of Volatile Organic Compounds (VOCs)	107
5.1	VOC Emission from Petrochemical / Synthetic Organic Chemical Manufacturing Industries / Polymer Processes	107
5.2	Categorisation of VOCs	107
5.3	Overview of Environmental Impact of VOCs	114
	5.3.1 Adverse physiological effects	114
	5.3.2 Damage to materials	115
	5.3.3 Photochemical oxidant production	115
	5.3.4 Stratospheric ozone depletion	115
	5.3.5 Global warming	115
	5.3.6 Odour	116
5.4	Criteria adopted for Categorisation of VOCs	116
5.5	VOC Impact Data used in the Project	116
	5.5.1 Adverse physiological effects	117
	5.5.2 Damage to materials	117
	5.5.3 Photochemical oxidant production	117
	5.5.4 Stratospheric ozone depletion	119
	5.5.5 Global warming	119
	5.5.6 Odour	120
5.6	Categorisation Method of VOCs	121
5.7	Findings in the Study	123
5.8	Reference	123
6.0	Emission Control Technologies in Petrochemical Industries	127
6.1	Combustion Control Devices	127
	6.1.1 Thermal incinerators	128
	6.1.2 Catalytic incinerators	128

S. No.	Items	Page No.
	6.1.3 Industrial boilers and process heaters	128
	6.1.4 Flares	128
	6.1.5 Halogenated streams	129
6.2	Product Recovery and Recapture Devices	129
	6.2.1 Condensers	129
	6.2.2 Adsorption	130
	6.2.3 Absorption	130
6.3	Control Techniques specific to Transfer Operations	131
	6.3.1 Vapour collection system	132
	6.3.2 Vapour balancing	132
	6.3.3 Route to a process for fuel gas system	132
6.4	Control Techniques Specific to Storage Vessel	132
	6.4.1 Fixed roof vessel	132
	6.4.2 Floating roof vessels	132
	6.4.3 Route to a process or a fuel gas system	133
6.5	Best Available Technology	133
	6.5.1 Best available technique for air pollution reduction in cracker furnace	133
	6.5.1.1 Emission control technology for existing cracker units in India	138
	6.5.2 Best available techniques for air pollution reduction for EO / EG	139
	6.5.2.1 Emission control priorities for existing plants of EO/EG	142
	6.5.3 Best available techniques for air pollution reduction for EDC and VCM	142
	6.5.4 Best available techniques for air pollution reduction for ACN	147
	6.5.4.1 Emission control priorities for existing plants	149
	6.5.5 Best available techniques for air pollution reduction for benzene and toluene	149
	6.5.6 Best available techniques for air pollution reduction of xylene	152
	6.5.7 Emission control priorities for existing units in India	152
7.0	Proposed Emission Standards and LDAR Guidelines	
7.0	Introduction	162
7.1	Air Pollutant and Risk Associated with them	162
7.2	Source of Pollutants in Petrochemical Plants considered for Development of Standards	163
	7.2.1 Volatile organic compounds (VOCs) emission sources	164
7.3	Approach to Emission Regulation	166
	7.3.1 Conventional parameters	166
	7.3.2 Inorganic pollutants	166
	7.3.3 VOC control	166
7.4	Present Status of Emission Control	167
7.5	Proposed National Emission Standards	167

S. No.	Items	Page No.
7.5.1	Emission standards for heater / furnace / boiler / vaporiser	168
7.5.2	Emission standards for organic particulates	168
7.5.3	Emission standards for process emission (specific organic pollutants)	168
7.5.4	Emission standards for VOC – HAPS from process vents	169
7.5.5	Emission standards for VOCs (general) from process vents	169
7.5.6	Standards for storage and transfer point (loading and unloading)	169
	7.5.6.1 Standards for atmospheric storage tanks of petrochemical products	169
	7.5.6.2 Storage of benzene, VCM and ACN	170
7.5.7	Standards for emission from loading of volatile products	170
7.6	LDAR Guidelines	171
	7.6.1 Guidelines for atmospheric storage tanks practices	171
	7.6.2 LDAR and monitoring protocol	171
	7.6.3 General notes	173
	Bibliography	175

LIST OF FIGURES

S. No.	Figure	Page No.
1.1	Petrochemical product tree	5
1.2	Methodology adopted for the Study	6
2.0	State-wise production in the year 2004-05	9
2.1.1	Sectoral usage pattern: ethylene	10
2.1.2	Sectoral usage pattern: propylene	11
2.1.3	Sector usage: butadiene	12
2.1.4	Sectoral usage pattern: benzene	13
2.1.5	Sectoral usage pattern: toluene	14
3.1	Block diagram – olefin manufacture	23
3.2	Simplified flow diagram – butadiene manufacture	45
3.3	Block diagram- EO manufacture	46
3.4	Block diagram – glycol manufacture	47
3.5	Block diagram – EDC / VCM manufacture (balance process)	48
3.6	Block diagram – acrylonitrile manufacture	49
3.7	Benzene / toluene extraction from pyrolysis gasoline (using liquid – liquid extraction)	50
3.8	Process flow diagram for hydro-treating	51
3.9	Benzene / toluene extraction for pygas using extractive distillation	52
3.10	Process flow diagram of a toluene dealkylation unit (HDA)	53
3.11	Toluene diproportionation process flow diagram (tatoray process)	54
3.12	Block diagram of xylene process (IPCL, Vadodara)	55
3.13	Process flow diagram for hydro-treating	56
3.14	Process flow diagram for reformer unit	57
3.15	Block diagram for maleic anhydride	58
3.16	Block diagram for phenol / acetone	59
3.17	Block diagram for TDI	60
3.18	Block diagram for phthalic anhydride	62
3.19	Manufacturing process and block diagram of DMT	63
5.1	Decision tree for categorisation of volatile organic compounds	126
6.1	Discrete burner, thermal incinerator	153
6.2	Catalytical incinerator	154
6.3	Steam – assisted elevated flare system	155
6.4	Schematic diagram of a shell and tube surface condenser	156
6.5	Two stage regenerative adsorption system	157
6.6	Packed tower absorption process	158
6.7	Tank truck loading with vapour recovery	159
6.8	Dual arm loading rack	160
6.9	Vapour balancing system	161

LIST OF TABLES

S. No.	Table	Page No.
1.1	Classification of petrochemical products	3
2.1	Industries with various feedstocks	7
2.2	Production and installed capacities for major intermediates in India	9
2.1.2	Propylene: usage ratios	11
2.1.3	Butadiene: usage ratios	12
2.1.4	Benzene: usage ratios	13
2.2.1	Plant-wise feedstock requirement	15
2.3.1.1	Ethylene oxide / ethylene glycol: installed capacities	16
2.3.1.2	Installed capacity: EDC / VCM	16
2.3.5.2	Phthalic anhydride (PA): capacity / production data	19
4.1	Cracker – flue gas analysis	70
4.2	Olefin complex (0.5 MMTPA ethylene): typical emission inventory	72
4.3	Emission sources and pollutants from various aromatic plants	73
4.4	Combustion emission to air from aromatics processes (in kgt/t feedstock)	73
4.5	Fugitive emissions – butadiene	75
4.6	Work place monitoring data	75
4.7	Monitoring of flue gases (Unit – V)	77
4.8	Process vent analysis (EO/EG)	78
4.9	Fugitive emissions calculations	79
4.10	Process vent analysis results – EDC / VCM	80
4.11	Analysis of incineration off-gases	81
4.12	Fugitive emission control practices – existing units	82
4.13	Estimation of fugitive emissions from a typical plant (Unit – I)	83
4.14	Acrylonitrile plant process vents (Unit-I)	84
4.15	Acrylonitrile plant stack emissions (Unit-I)	86
4.16	Fugitive emission prevention – acrylonitrile (Unit – I)	86
4.17	Component fugitive emission – acrylonitrile (Unit – I)	87
4.18	Analysis results – phthalic anhydride absorber vent (Unit – VI)	88
4.19	Analysis results – adsorber off-gas analysis (Unit – VII)	88
4.20	Tanker loading practices – benzene	89
4.21	Work area benzene monitoring levels near tanker loading bay (situation: no vapour collection / control device provide) (Unit – V)	90
4.22	Monitoring at tanker lading bay emission control system (Unit – V)	90
4.23	Storage practices for liquid hydrocarbons	91
4.24	Storage practices for benzene	92
4.25	Monitoring of emission during tank filling	93
4.26	Monitoring of emission during tank breathing	93
4.27	Storage emission – EO / EG plant	94

S. No.	Table	Page No.
4.28	Storage emission – EDC plant (Unit – I)	95
4.29	Storage emission ACN plant (Unit – I)	96
4.30	Comparison of elevated flares in petrochemical units	100
4.31	Leaking indices for a centrifugal pump with different types of seals	102
4.32	Average emission factors for fugitive emissions	104
4.33	Leaking and non-leaking emission factors for fugitive emissions (kg/hr source)	105
4.34	Stratified emission factors for equipment leaks (kg / hr source)	106
5.1	VOC emissions in petrochemical / synthetic organic chemical manufacturing industry (SOCMI)/polymer process	108
5.2	Categorisation of volatile organic compounds (VOCs)	124
6.1	Maximum emission levels in treated off-gas	159
7.1	Emission of inorganic pollutants from petrochemical plants	170
7.2	Volatile organic compounds emission from point and non-point source	171

LIST OF ANNEXURE

S. No.	Annexure	Page No.
I	References List	184

LIST OF ACRONYMS

ABS	-	Alkyl Benzene Sulphonate
AF	-	Acrylic Fibre
BAT	-	Best Available Technology
BPCL	-	Bharat Petroleum Corporation Limited
BRPL	-	Bongaigaon Refineries & Petrochemical Limited
CAA	-	Cuprous Ammonium Acetate
CRL	-	Cochin Refinery Limited
DEA	-	Di-ethanol amine
DMF	-	Di-methyl Formamide
DMT	-	Dimethyl Terephthalate
DVH	-	Dry-vent Header
EB	-	Ethyle Benzene
EDC	-	Ethylene Dichloride
EFR	-	External Floating Route
EG	-	Ethylene Glycols
EO	-	Ethylene Oxide;
GAIL	-	Gas Authority of India Limited
GWP	-	Global Warming Potential
HAD	-	Hot Alkali Digester
HCN	-	Hydrogen Cyanide
HDA	-	Hydrodealkylation
HDPE	-	High density polyethylene
HOCL	-	Hindustan Organic Chemical Limited
HPCL	-	Hindustan Petroleum Corporation Limited
HPL	-	Haldia Petrochemical Limited
IARC	-	International Agency for Research in Cancer
IFR	-	Internal Floating Route
IOC	-	Indian Oil Corporation
IPA	-	Isopropyl alcohol
IPCL-MGCC	-	Indian Petrochemical Corporation Limited – Maharashtra Gas Cracker Complex
ISBL	-	Inside Battery Limit
LDAR	-	Leak Detection And Repair
LDPE	-	Low density polyethylene
LNB	-	Low Nox Burner
LPG	-	Liquefied Petroleum Gas
MA	-	Maleic anhydride
MDI	-	Methylene Diphenyl Di-isocyanate
MMTPA	-	Million Metric Tonne Per Annum
MNT	-	Mono-nitro Toluene
MRL	-	Mangalore Refinery Limited
MTD	-	Meta Toluene Diamine
NEP	-	National Environmental Policy
NFY	-	Nylon filament Yarn
NGL	-	Natural Gas Liquid
NMP	-	N-methyl Pyrolidone

NOCIL-TTC	-	National Organic Chemical Industries Limited – Trans Thane Creek
OA	-	Oswal Agro
ODCB	-	Ortho Dichloro Benzene
ODP	-	Ozone Depleting Potential
OSBAL	-	Outside Battery Limit
PA	-	Phthalic anhydride
PAREX	-	p-Xylene
PBR	-	Poly Butadiene Rubber
PFY	-	Polyster Filament yarn
PG	-	Proplene Glycol
PGH	-	Pyrolysis Gasoline Hydrogenation
PO	-	Propylene Oxides
POCP	-	Photochemical Ozone Create Potential
PR	-	Polyurathene Resins
PRV	-	Pressure Relief Valve
PSF	-	Polyster staple fibre
PTA	-	Terephthalic acid
PVC	-	Poly Vinyl Chloride
RIL	-	Reliance India Limited
RINL	-	Rashtriay Ispat Nigam Limited
SAIL	-	Steel Authority of India
SBR	-	Styrene Butadiene Rubber
SF	-	Synthetic Fibre
SOCMI	-	Synthetic Organic Chemical Manufacturing Industry
SRV	-	Safety Relief Valve
TDI	-	Toluene Di-Isocyanate
TLV	-	Threshold Limit Value
TPA	-	Tonne Per Annum
TPM	-	Total Particulate Matter
TVP	-	True Vappor Pressure
TWA	-	Time Waited Average
ULNB	-	Ultra Low Nox Burner
VCM	-	Vinyl Chloride Monomer
VOC	-	Volatile Organic Compound
WVH	-	Wet vent Header
MEG	-	Mono Ethylene Glycol

CHAPTER-1

INTRODUCTION

1.1 Introduction

Petrochemicals are hydrocarbons, obtained from naturally occurring raw materials viz. petroleum, natural gas, coal etc. Coal was initially the basic raw material for organic chemical industry. However the basic feedstock has changed recently from coal to petroleum. This is attributed to the recent innovation and technological advance in the field of chemical industry based on petroleum feedstock. The handling and processing cost of petroleum based raw materials to down-stream products are cheaper than that of based on coal even though the cost of coal is cheaper than the petroleum based feedstock. The emergence of downstream petrochemical products manufacturing industries (popularly called synthetic organic chemicals manufacturing industries) like high polymers, synthetic fibres, plastic and plasticizers, synthetic rubbers, pesticides, carbon black, detergents, fertilisers and other similar products are outcome of the technological developments in the field of chemicals based on petroleum feedstock. These feedstock's can either be cracked (in cracker complexes) to produce olefins or reformed (in aromatic complexes) to produce aromatics. These olefins and aromatics are grouped together as basic petrochemicals and form the major building blocks.

Synthetic organic chemicals can also be obtained from other alternative sources like ethyl alcohol from molasses or acetylene from calcium carbide or benzene from coke oven by products. But through the application of new process technology in the field of petrochemicals based on feedstock available from refineries, there is a positive shift to petroleum feedstock. The raw materials of petroleum origin are crude oil, natural gas, off gases residues from refinery. In general, the manufacturing process of petrochemicals involves raw materials undergoing one or more chemical reactions followed by different unit operations to separate the product from side products and co-products.

The ranges of chemicals in systematic sequential chain produced in petrochemical industries are presented in Fig. 1.1.

1.2 Classification

The entire product spectrum can be classified into the following three classes:

- Building block or primary petrochemical products
- Intermediate products or secondary petrochemical products, produced from building block
- Final or end products, coming from intermediate products.

The chemicals falling under the three classes are listed in Table 1.1. Each class is further classified based on nature of products.

Table 1.1: Classification of Petrochemicals products

Feedstock	Primary products	Intermediate products	Final Products
Naphtha	<u>Olefins/Diolefins</u> 1. Ethylene 2. Propylene 3. Butadiene <u>Aromatics</u> 1. Benzene 2. Toluene 3. Xylene	<u>Organics</u> 1. Ethylene Oxide 2. Ethylene Glycols 3. Propylene Oxides 4. Isopropyl alcohol 5. Acetone 6. 2-Ethyl alcohol 7. Phthalic anhydride(PA) 8. Maleic anhydride(MA) 9. Phenol 10. Styrene 11. Polyethylene 12. Chlorinated hydrocarbon 13. Isocyanates 14. Cumene 15. Butanol <u>Synthetic fibre</u> 1. Caprolactum 2. Dimethyl Terephthalate(DMT)/ Terephthalic acid(TPA) 3. Acrylonitrile	<u>Plastics and resins</u> 1. High density polyethylene (HDPE)/ Low density polyethylene (LDPE) 2. Polypropylene 3. Poly Vinyl Chloride (PVC) 4. Polystyrene 5. Alkyl Resins 6. Polyurathene Resins 7. Resins PF 8. Alkyl Benzene Sulphonate (ABS) Resins <u>Synthetic Fibre:</u> 1. Nylon filament Fibre 2. Nylon tyre cord and other fibre 3. Polyester Filament yarn 4. Polyester staple fibre 5. Acrylic Fibre 6. Polypropylene fibre <u>Synthetic Rubber:</u> 1. Styrene Butadiene rubber 2. Poly Butadiene Rubber

1.3 Approach for development of emission standards

Petrochemical industries manufacture various products and comprises of multiple processing units at one specific location adopting different technologies, equipments, unit process and unit operation from a basic feed stocks. It leads to generate wide spectrum of emission of air pollutants, mainly of volatile organic compounds (VOC's). Some of them are toxics, carcinogenic. Some are responsible for damage to materials. Some of them have potential to photochemical oxidant creation, global warming, ozone depleting and creation of malodour. Besides these various types of VOC's, there are generations of various types of inorganic hazardous air pollutants. In addition to above, the generation of conventional air pollutants are there.

In order to reduce the air emission to an acceptable level, it is necessary to adopt a comprehensive approach considering, thermal destruction, good engineering practices and possible end of pipe technology with due regard to techno-economic feasibility within the frame work of National Environmental Policy (NEP), 2006. The salient feature of NEP with respect to standard, are as follows:

- Risk reduction related to health, ecosystem and manmade assets.
- General availability of required technology and techno-economic feasibility.
- Achievement of the ambient air quality standard for the location concerned.
- Quality as well as quantity of pollutants emitted.

With this backdrop, the Central Pollution Control Board had taken up a study to develop national emission standard for petrochemical manufacturing units -basic and intermediate product as outlined in Fig. 1.1.

1.4 Methodology

The basic steps to develop the emission characterisation and assessment of petrochemical are as follows:

- (i) Compiling reliable emission inventory depending on type of feed stock / products and the process technology generally adopted.
- (ii) Implementing the optimum strategy to minimise the emission reduction at the source and recovery at the source.
- (iii) Review of data and strategies to mitigate process emission to attain goal.
- (iv) Adaptation of proper & proven end of pipe (EOP) technologies for disposal / destruction (viz. flaring / incineration etc.)

The study was divided into three phases as under:

- (i) Literature studies
- (ii) Industrial survey
 - Assessment of air pollutants, categorisation of VOC 's and short-listing of chemicals for further study
 - Review of international standards
- (iii) Detailed case studies on selected petrochemicals

The detailed Methodology (phase wise) adopted for the study is presented in Fig. 1.2.

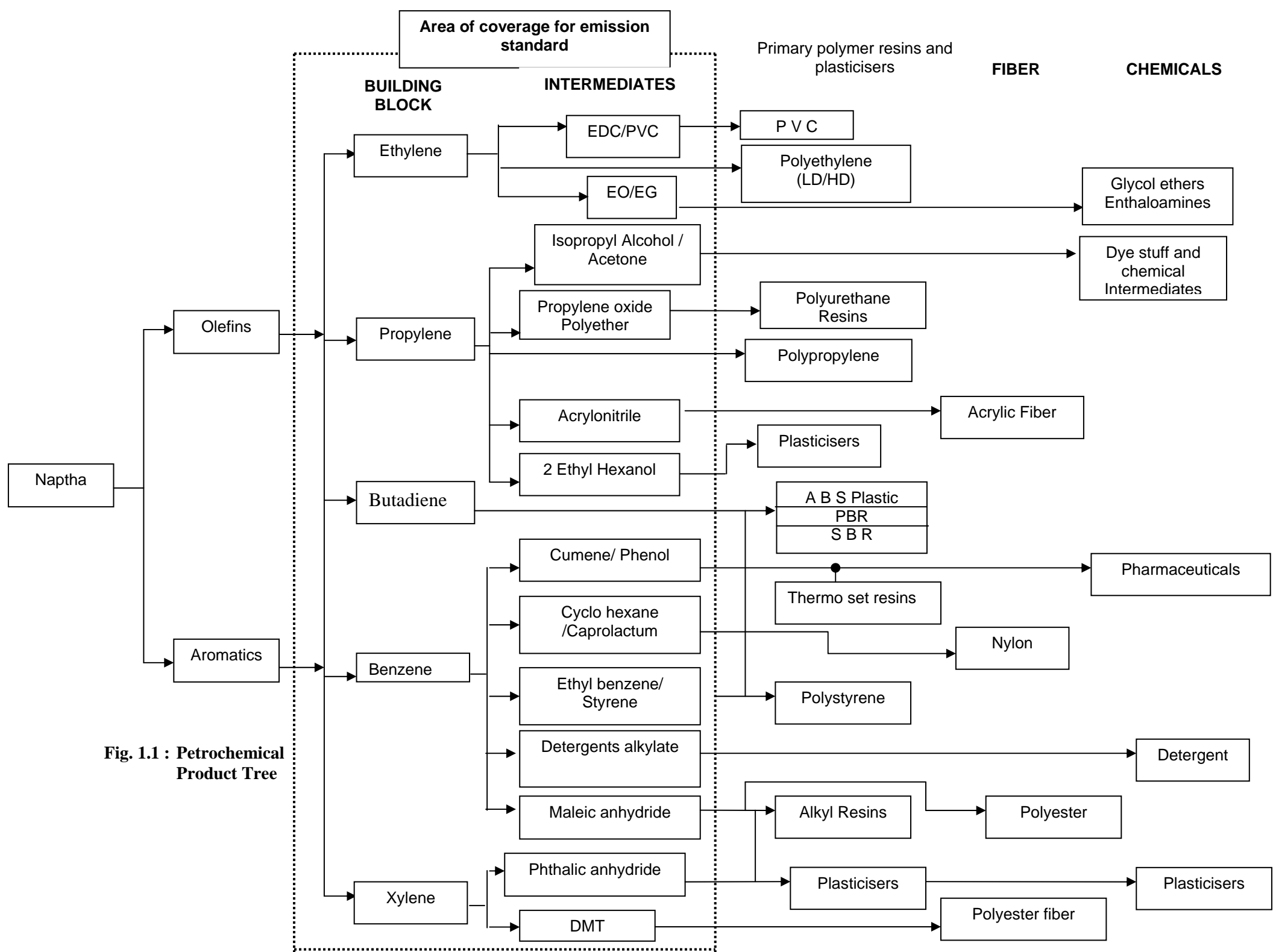

Fig. 1.1 : Petrochemical Product Tree

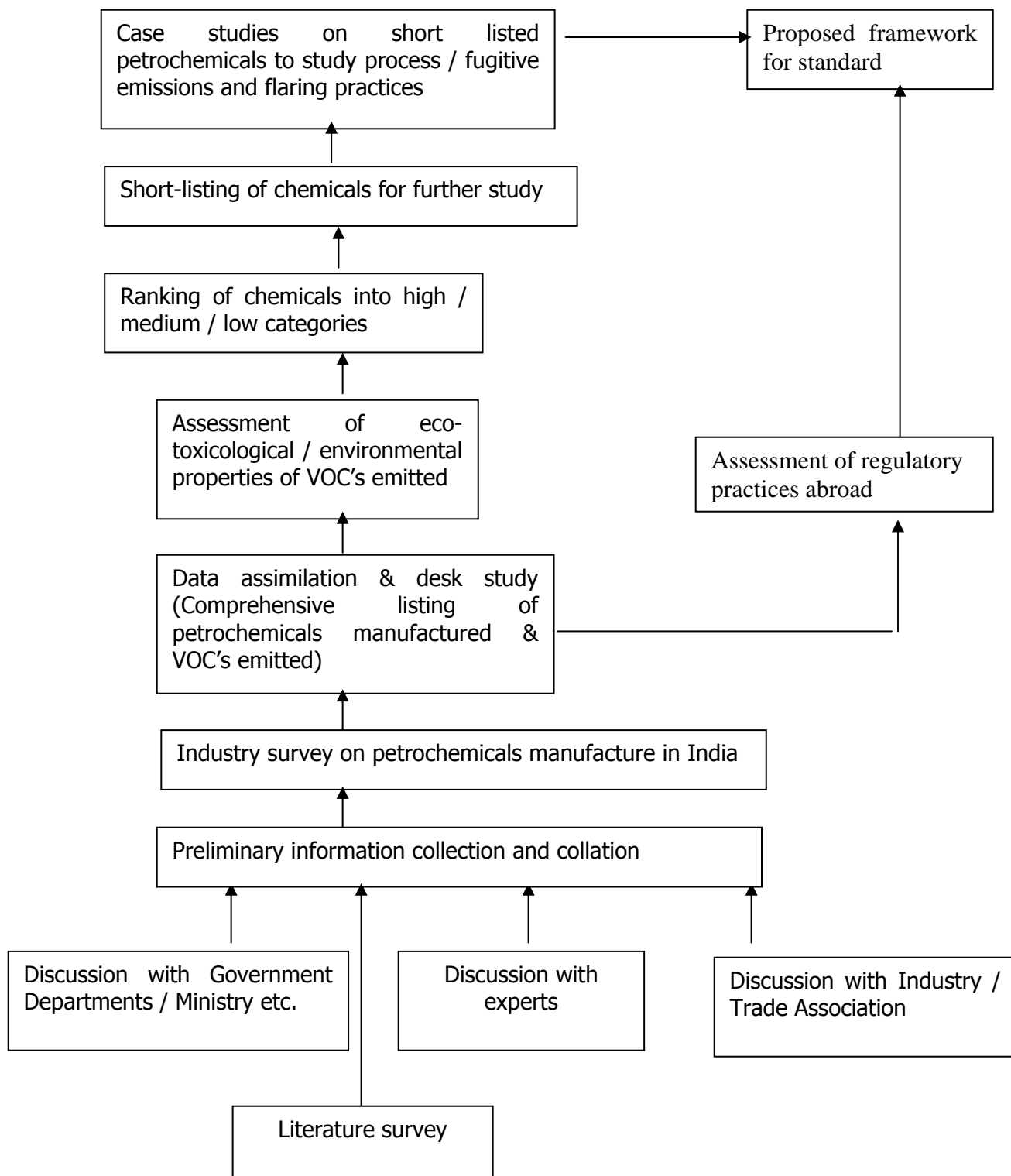

Fig. 1.2: Methodology adopted for the study

CHAPTER- 2

2.0 STATUS OF PETROCHEMICAL INDUSTRY IN INDIA

Petrochemical industry in India is growing steadily. The locations of petrochemical units are given in Table 2.1 along with feedstock. It is observed from Table 2.1 that the major feedstock in Indian petrochemical units is naphtha and natural gas. It is also indicated that from feedstock of natural gas, olefins compounds are produced. In refinery, generally aromatic compounds are produced. The major intermediate products produced in the country are ethylene, propylene, butadiene, benzene, toluene and xylene. Of course, petrochemical products are produced throughout countries as indicated in Table 2.1. However, the major petrochemical complexes are located in the State of Maharashtra and Gujarat. The first naphtha cracker unit (Olefins) M/s United Carbide India Limited (UCIL) went into production in Mumbai at the end of 1960. M/s National Organic Chemical Industry Limited (NOCIL), Thane near Mumbai went into production in the year 1966. The third petrochemical complex *i.e.* M/s Indian Petrochemical Limited (IPCL), Vadodara, using naphtha with facilities of production of primary, intermediate and downstream petrochemical products started during 1978-79. M/s IPCL commissioned their gas-cracking unit in 1989 at Nagothane in Maharashtra. M/s Reliance India Limited (RIL) commissioned their plant in 1997 at Hazira, Gujarat. In the year 1999-2000 three petrochemical complexes came into existence, these are M/s Haldia Petrochemical, West Bengal, M/s Gas Authority of India Limited (GAIL), Auriya, Uttar Pradesh, M/s IPCL, Gandhar in Gujarat.

Table 2.1: Industries with various feedstock

S. No.	Name of Industry	Feedstock
1	Bongaigaon Refineries, Assam	Naphtha
2	Bharat Petroleum Corporation Limited, Mumbai, Maharashtra	Naphtha
3	Cochin Refinery Limited, Ernakulam, Kerala	Naphtha
4	Gas Authority of India Limited, Auriya, Uttar Pradesh	Natural gas
5	Hindustan Organic Chemical Limited, Cochin, Kerala	Gas
6	Hindustan Petroleum Corporation Limited, Vizag, Andhra Pradesh	Gas
7	Haldia Petrochemical Limited, Haldia, West Bengal	Naphtha
8	Indian Oil Corporation, Mathura, Uttar Pradesh	Gas
9	Indian Oil Corporation, Koyali, Vadodara, Gujarat	Naphtha

S. No.	Name of Industry	Feedstock
10	Indian Petrochemical Corporation Limited, Vadodara, Gujarat	Naphtha
11	Indian Petrochemical Corporation Limited, Gandhar, Gujarat	Natural gas
12	Indian Petrochemical Corporation Limited, Nagothane, Maharastra	Natural gas
13	Mangalore Refinery Limited, Mangalore, Karnataka	Gas
14	National Organic Chemical Industries Limited, Thane, Maharashtra	Naphtha
15	Oswal Agro, Mumbai, Maharashtra	Naphtha
16	Reliance India Limited, Hazira, Gujarat	Naphtha / Natural gas
17	Reliance India Limited, Jamnagar, Gujarat	Gas
18	Reliance India Limited, Patalganga, Maharashtra	Naphtha
19	Rashtriya Ispat Nigam Limited, Vizag, Andhra Pradesh	Naphtha
20	Steel Authority of India Limited, Bhilai, Chhattisgarh	Coke oven gas
21	Steel Authority of India Limited, Bokaro, Jharkhand	Coke oven gas
22	Steel Authority of India Limited, Durgapur, West Bengal	Coke oven gas
23	Steel Authority of India Limited, Rourkela, Orissa	Coke oven gas

The State-wise production in the year 2004-05 is given below

Gujarat	-	59%
Maharastra	-	17%
West Bengal	-	12%
Uttar Pradesh	-	04%
Tamil Nadu	-	03%
Other	-	05%

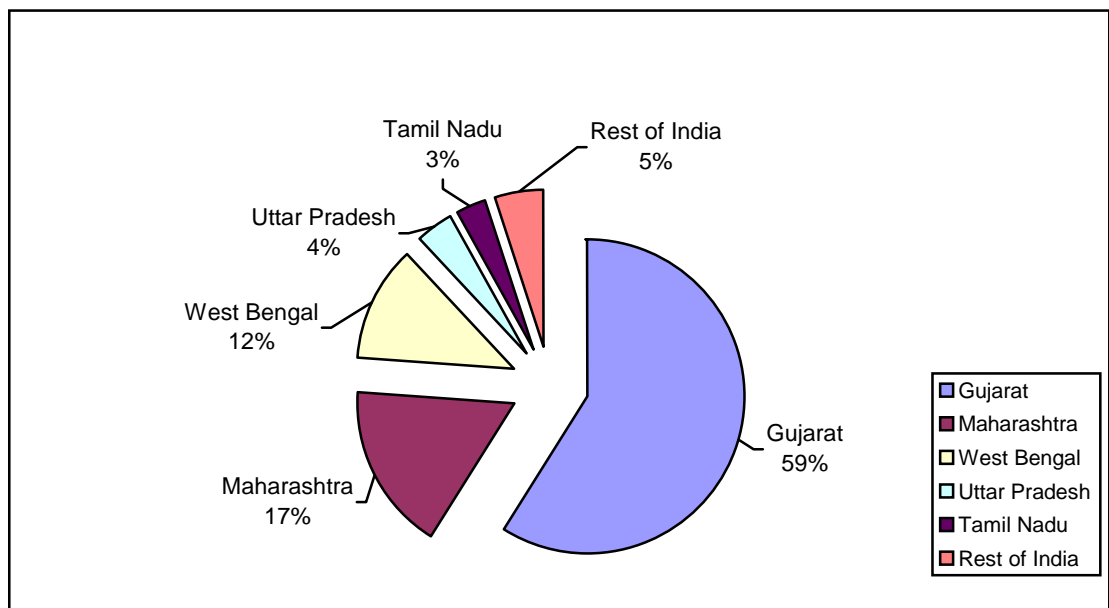

Fig 2.0: State wise production in the year 2004-05

With installation of so much units, the installed capacities of major intermediate products such as ethylene, propylene, butadiene, benzene, toluene and xylene has increased, which are summarised in Table 2.2.

Table 2.2: Production and Installed capacities of major intermediates in India

	Ethylene (TPA)		Propylene (TPA)		Butadiene (TPA)	
	Production	Installed	Production	Installed	Production	Installed
Total in 1997-98	1181400	2497000	580204	1559600	31000	121600
Total in 2004-05	2645000	2513000	1892000	1549000	131000	141000

	Benzene (TPA)		Toluene (TPA)		Xylene (TPA)	
	Production	Installed	Production	Installed	Production	Installed
Total in 1997-98	357057	836220	87587	176335	220380	1835000
Total in 2004-05	640000	741000	177000	280000	146000	229000

Source: Annual report of 2005-06, Department of Chemical and fertiliser, Government of India

2.1 Usage pattern of basic intermediates

2.1.1 Ethylene

Ethylene is the basic petrochemical. All cracker complexes are designed with fixed ethylene capacity and other capacities are decided upon the basis of ethylene production. Ethylene is the basic building block of polyethylene (PE), polyvinyl chloride (PVC) and ethylene glycol. Ethylene is a prime raw material for downstream petrochemicals. Usage ratio of ethylene in the manufacture of various downstream petrochemicals is given below:

Product	Ethylene required per unit
LDPE/ LLDPE	1.03
HDPE	1.04
PVC	0.54
EO	0.80
MEG	0.62
STYRENE	0.33
AO	1.03

It is observed from the ratio that polyethylene like LDPE / LLDPE, HDPE are the major ethylene based down streams products. End use pattern for ethylene according to sector of usage is presented in Fig. 2.1.1.

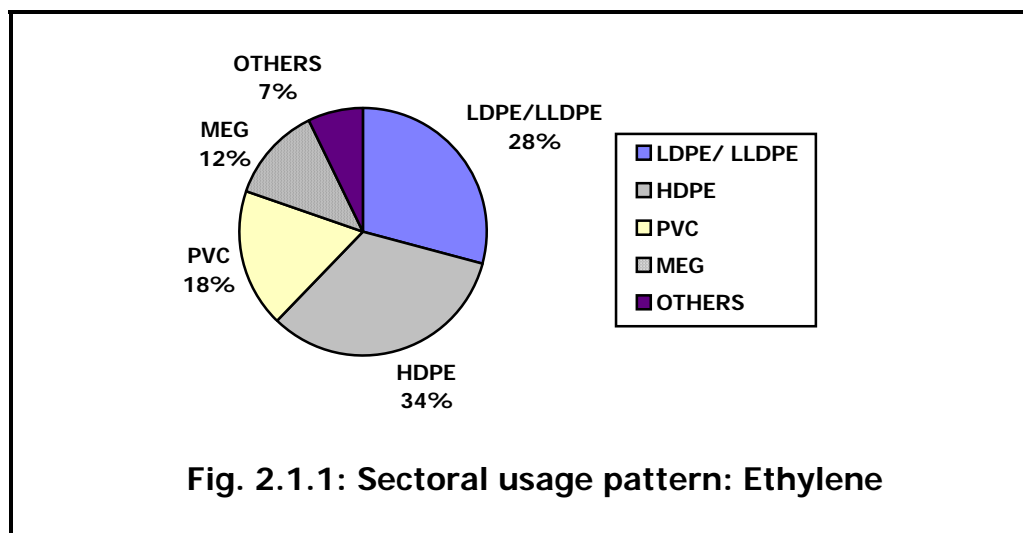

2.1.2 Propylene

Propylene is a co-product of ethylene from a cracker complex. It can also be produced by refineries, which set up a propylene recovery unit. The most important end-uses are polypropylene, acrylonitrile, (used to make acrylic fibre,

elastomers like acrylonitrile butadiene rubber: ABR, and speciality polymers like acrylonitrile butadiene styrene: ABS) and cumene, which is further processed into co-products – acetone and phenol. Usage ratio of propylene is given in Table 2.1.2 and sector-wise usage pattern is presented in Fig 2.1.2.

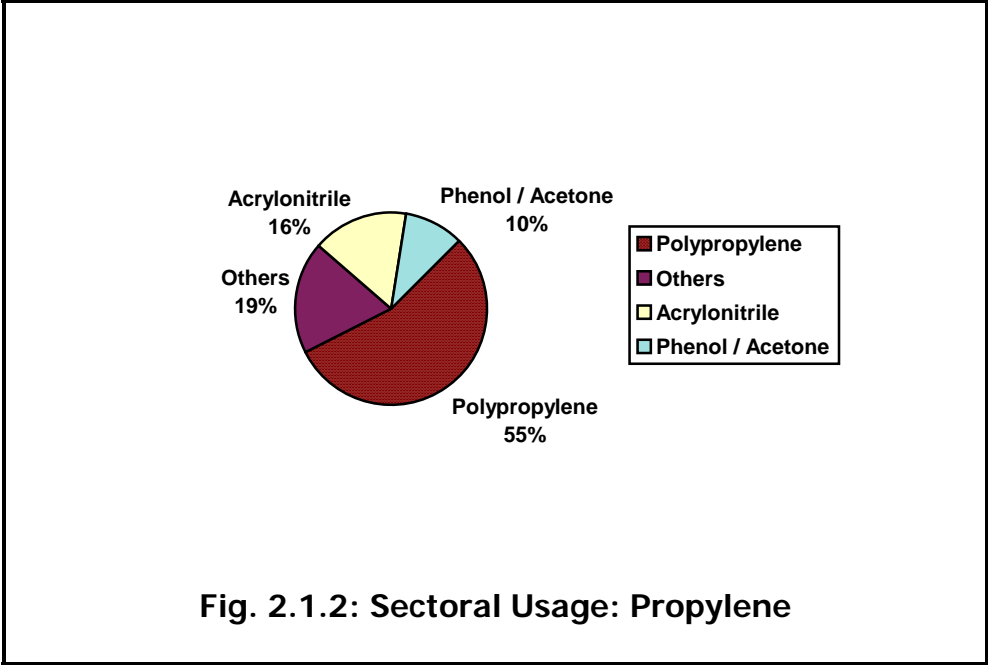
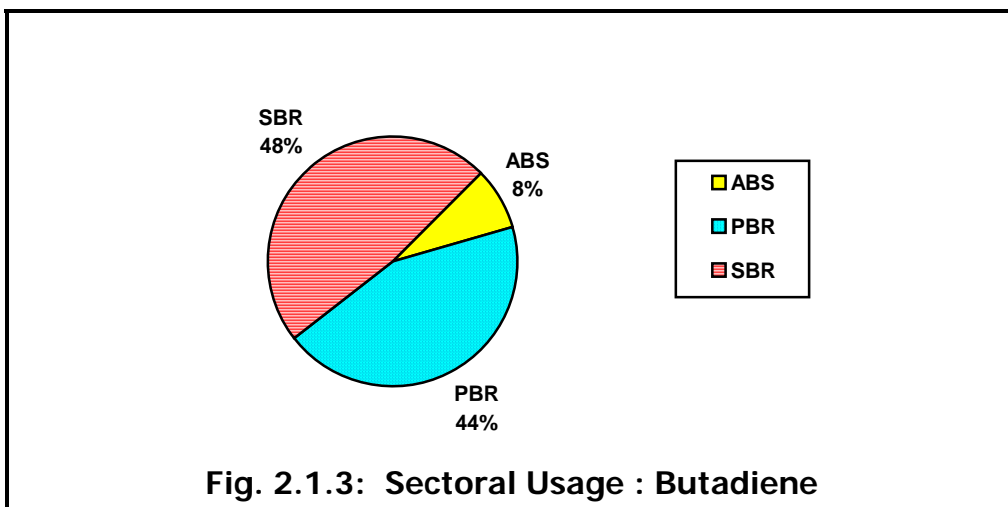

Table 2.1.2: Propylene: Usage Ratios

Downstream Chemical	Propylene required per unit
Polypropylene	1.02
Acrylonitrile	1.10
Phenol / Acetone	0.60

2.1.3 C4 Fractions –Butylenes / Butadienes

C4 fractions are co-produced during manufacture of ethylene and propylene in a cracker complex and during catalytic cracking process in refineries. Butadienes are used mainly for synthetic rubber (styrene butadiene rubber: SBR, poly butadiene rubber: PBR), and engineering plastic (acrylonitrile butadiene styrene: ABS). Sector-wise usage of Butadiene is presented in Fig 2.1.3.



Usage ratio of Butadiene for the manufacture of various products is presented in **Table 2.1.3**

Table 2.1.3: Butadiene : Usage Ratio

Product	Butadiene required per unit
Styrene Butadiene Rubber	0.52
Poly Butadiene Rubber	0.70
Acrylonitrile Butadiene Styrene	0.20

2.1.4 Benzene

Benzene is a basic aromatic chemical. In India, it is produced from a variety of sources: recovered from pyrolysis gasoline (during naphtha cracking), by reforming of naphtha (in refineries), and in steel plants, as a recovery product from coke oven gas obtained during the carbonisation of coal. Benzene is used as a raw material for several important products. These include caprolactum (used for making nylon filament yarn: NFY), linear alkyl benzene: LAB (which is used in detergents), styrene (used in polystyrene and styrene butadiene rubber), phenol (used for laminates), nitro-benzene and chloro-benzenes (dye intermediates), and pesticides (DDT and malathion). Sector-wise usage pattern for benzene is depicted in **Fig 2.1.4**.

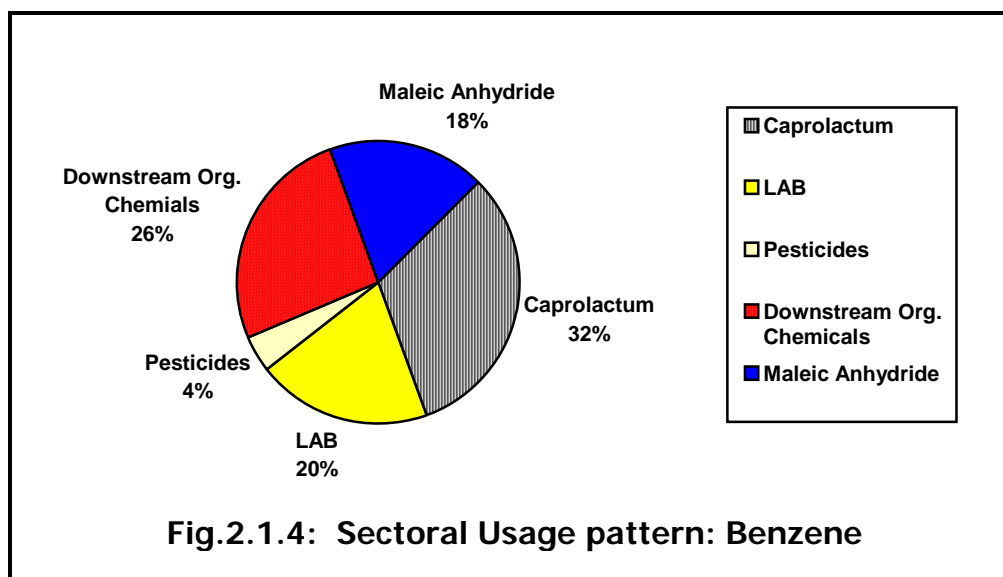

Unit wise consumption of Benzene for manufacture of various down stream products is indicated in Table 2.1.4.

Table 2.1.4: Benzene: Usage Ratios

Product	Benzene required per unit
Caprolactum	1.00
LAB	0.37
Styrene	0.75
Phenol	1.16
Others	1.33

2.1.5 Toluene:

Toluene is a basic aromatic chemical produced in reformer along with benzene and xylene. It is also produced as a by-product of naphtha cracking. It is mainly used as a solvent in a wide range of end-use sectors. The other major end uses are nitrotoluenes, toluene sulphonamide, dyes, pesticides, chlorinated derivatives and drugs. Sectoral usage of Toluene is presented in Fig. 2.1.5

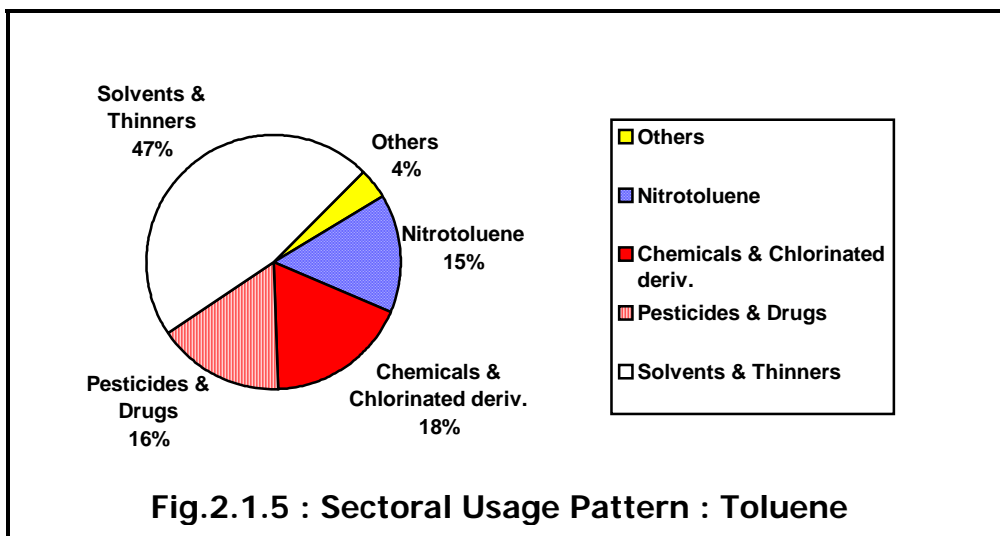

2.1.6 Xylene

Commercially important xylenes are of two kinds: paraxylene and orthoxylene. Para xylene is used for the manufacture of DMT and PTA and this is the backbone of the synthetic fibre industry. Ortho xylene is mainly used in the production of phthalic anhydride (used for manufacture of plasticisers / paints / thinners). Ortho xylene and para xylene are produced in a reformer with naphtha or C5 reformat as inputs.

2.2 Feedstock Choice

A wide range of alternative feed stocks such as naphtha, ethane/propane, alcohol, LPG, NGL and gas oil can be used for production of Petrochemicals. In India, naphtha and C2/C3 fractions from natural gas are the main feedstock used. LPG is normally used as domestic fuel, while gas oil is not used because it is heavier fraction and needs complex processing. In India, some refineries crack LPG in their fluid catalytic cracking units to produce propylene. Summary of various feedstock used by Indian petrochemicals majors is presented in **Table 2.2.1**

From the table, it is apparent that about 59% of India's cracking capacity is based on natural gas, whereas 40% is based on Naphtha feedstock. Industrial alcohol which was an attractive feedstock in the days of alcohol price control is no longer an important feedstock and accounts for only 0.8% of the total ethylene production in the country. The major factors, which affect the choice of feedstock, are the relative yields of olefins and aromatics desired, energy costs, investment levels, availability and relative pricing. Natural gas and NGL yield a much higher proportion of ethylene. Hence, they are preferred when the polyolefins output of a cracker is sought to be maximised. On the other hand

naphtha is preferred when a wider range of output products (including propylene and butadiene derivatives) is desired.

Table 2.2.1: Plant-wise feedstock requirement

Complex	Ethylene Capacity (TPA)	Feed stocks
IPCL, Vadodara	1,30,000	Naphtha
IPCL-MGCC, Nagothane	4,00,000	Gas (C ₂ /C ₃ 7:3), ethane-propane fraction
IPCL, Gandhar	3,00,000	Gas (C ₂ /C ₃ 7:3), ethane-propane fraction
RIL, Hazira	7,50,000	Naphtha / Natural Gas Liquid
NOCIL, Thane	75,000	Naphtha
HPL, Haldia	4,20,000	Naphtha
GAIL, Auriya	4,00,000	Gas (C ₂ /C ₃ 9:1)
Oswal Agro, Mumbai	22,000	Alcohol

2.3 Downstream Petrochemicals

Downstream Petrochemicals are the products made from basic petrochemicals and thus are derivatives of naphtha or gas. The downstream petrochemicals can be further classified into the Synthetic Organic Chemical Manufacturing Industry (SOCMI) (comprising chemicals/intermediates made from basic petrochemicals) and polymers (such as polyethylene / PVC *etc.*). The detail of downstream petrochemicals production in India is given below.

2.3.1 Products Based on Ethylene

2.3.1.1 Ethylene Oxide (EO) and Ethylene Glycol (EG)

Ethylene oxide is an intermediate product during the manufacture of mono ethylene glycol (MEG). In India, EO is produced through the Petrochemical and alcohol routes. Ethylene glycol used in the polyester fibre / filament industry (@70%) with minor usage in explosive and anti-freeze coolants.

Installed capacities for ethylene oxide/ethylene glycols are given in Table 2.3.1.1

Table 2.3.1.1: Installed capacities of ethylene oxide/ethylene glycol

Unit	Location	Capacity (TPA)	Feedstock
IPCL	Vadodara, Gujarat	20,000	Naphtha ethylene
NOCIL	Thane, Maharashtra	24,000	Naphtha ethylene
RIL	Hazira, Gujarat	3,40,000	Naphtha / NGL ethylene
SM Dyechem	Pune, Maharashtra	14,000	Alcohol ethylene
India Glycols		13,000	Alcohol ethylene
IPCL-MGCC	Nagothane, Maharashtra	55,000	Gas ethylene
IPCL	Gandhar, Gujarat	1,20,000	Gas ethylene

Ethylene oxide finds other uses in surfactants (50%), dye and dye intermediates, amine derivatives and glycol ethers.

2.3.1.2 Ethylene Dichloride/Vinyl Chloride

Ethylene dichloride is an intermediate for vinyl chloride monomer, which polymerises to polyvinyl chloride (PVC). Installed capacities of major units are presented in **Table 2.3.1.2**

Table 2.3.1.2: Installed capacity of EDC / VCM

S. No.	Manufactured	Year of Establishment	Technology Supplier	Design Capacity (TPA)
1	IPCL, Vadodara	1983-84	Stauffer Chemicals, USA	57,300
2	IPCL, Dahej	1997-98	Innovyl Belgium	1,70,000
3	NOCIL, TTC	1961	Shell, Netherlands	30,000
4	RIL, Hazira	1996	Geon, USA	2,70,000
5	Finolex Pipes Limited, Ratnagiri	1992/2003	UHDE, Germany	2,40,000
Installed Capacity Data – Basis VCM				

2.3.1.3 Ethyl Benzene/Styrene:

Major use of Ethyl Benzene is for production of styrene. Ethyl Benzene is made by alkylation of Benzene in presence of catalyst.

2.3.2 Propylene Based Petrochemicals

2.3.2.1 Propylene Oxide and Propylene Glycol

Propylene Oxide is used for the manufacture of propylene glycol which finds application in Polyester resins, cellophane and food and drug industries. Propylene oxide is produced by the direct oxidation of propylene.

2.3.2.2 Acrylonitrile ($\text{CH}_2=\text{CHCN}$)

Acrylonitrile (ACN) is the basic input for the production of acrylic fibre (AF). It is also used to produce acrylonitrile butadiene styrene rubber (ABS) and acrylates. Acrylonitrile is produced by air oxidation of propylene and ammonia mixture. IPCL is the sole producer of ACN in India producing about 30,000 TPA at its Vadodara Complex.

2.3.2.3 Isopropyl Alcohol [$(\text{CH}_3)_2 \cdot \text{CHOH}$]

Isopropanol finds its largest use as multipurpose industrial solvent and for manufacture of various drugs and fine chemicals. NOCIL (25,000 TPA), Herdellia in Thane district and IOC in Raigad, Maharashtra manufacture Isopropanol from propylene.

2.3.2.4 Cumene [Isopropyl Benzene - $\text{C}_6\text{H}_5 \cdot \text{CH} \cdot (\text{CH}_3)_2$]

Cumene is produced by propylene alkylation of Benzene. Most of the cumene produced is used for captive production of phenol / acetone. HOC - Ernakulum unit extracts propylene from LPG supplied by Cochin refineries limited and uses this for the production of cumene. Its installed capacity is 54,000 TPA. Herdellia chemicals, Thane gets propylene from NOCIL / MRL and uses this for production of cumene. Its installed capacity is 40,000 TPA.

2.3.2.5 Phenol / Acetone

Phenol is used to produce phenol - formaldehyde resins and derivatives such as bisphenol - A, salicylic acid and alkyl phenols. Acetone is used as a solvent, for manufacture of chemicals such as acetone cyanohydrin, di-acetone alcohol, in pesticides, pharmaceuticals, explosives *etc.* Phenol and acetone are co-produced from air oxidation of cumene and benzene (cumene in turn is produced from propylene). Hence, phenol and acetone economics are closely interlinked. Acetone is also produced through the alcohol route. The current installed capacity for phenol is about 65,000 TPA. Acetone capacity is about the same, with 50,000 TPA produced as co-product of phenol and remaining through the alcohol route.

2.3.2.6 Butanol and 2-Ethyl Hexanol

An oxo process involves substitution of HCHO across a double bond using a reaction of olefin and CO + H₂ synthesis gas. The primary product is an aldehyde (CHO group), which can be hydrogenated to an alcohol. NOCIL employs the oxo process for manufacture of Butanol (normal and iso) and 2 Ethyl hexanol. The total capacity for chemicals manufactured by the process is 20,000 TPA.

2.3.3 Petrochemicals from Benzene

2.3.3.1 Cyclohexane and Caprolactum

Cyclohexane is used as an intermediate for production of caprolactum and as a solvent for manufacture of HDPE. It is produced by hydrogenation of Benzene. Cyclohexane is produced in the country by GSFC, Gujarat and FACT, Cochin both manufacture caprolactum. Caprolactum is the main input for the production of nylon filament yarn, nylon tyre cord and nylon industrial yarns caprolactum is made from cyclohexanone oxime, which is obtained by treating cyclohexanone with hydroxylamine.

2.3.3.2 Maleic Anhydride (MAN-C₄H₂O₃)

Maleic anhydride (MAN) is used to produce agrochemical, unsaturated polyester resins, alkyd resins and food acids. These in turn are used in a wide range of end use sectors including engineering plastics, helmets, tabletop lamination, pharmaceuticals, varnishes, paints etc. MAN is manufactured by air oxidation of Benzene or n-Butadiene in a process similar to phthalic anhydride. Major producers include Thirumalai Chemicals, Tamilnadu (10,000TPA) and Ganesh Anhydride, Tarapur, Maharashtra (12,000 TPA). Total capacity in 1994-95 was 34,950 TPA, around 75% of MAN output is exported.

2.3.4 Petrochemicals from Toluene

2.3.4.1 Toluene Di Isocyanate (TDI)

TDI is used in the manufacture of polyurethane plastics. It is manufactured by phosgenation of toluene diamine. The sole producer of TDI in the country is Narmada Chemateur India Ltd. Production capacity is 10,000 TPA.

2.3.5 Chemicals from Xylene

2.3.5.1 Terephthalic Acid (PTA) and Dimethyl Terephthalate (DMT)

Purified terephthalic acid (PTA) and dimethyl terephthalate (DMT) are substitute raw materials for production of polyesters (PSF, PFY, PET, polyester films and chips). There are only four manufacturers of DMT / PTA in India. Reliance is the sole producer of PTA at its Patalganga and Hazira plants. Bombay Dyeing (Patalganga), IPCL (Vadodara) and BRPL, Assam produce DMT.

2.3.5.2 Phthalic Anhydride (PAN)

Phthalic anhydride is used to produce unsaturated polyester resins, esters, alkyd resins, specific dyes and pigments. These in turn are used in a wide range of applications of which the most important are the PVC processing industry (esters) and the paint industry (alkyd resins). Ortho xylene is the main raw material of PAN. The installed capacity and production data for phthalic anhydride are presented in **Table 2.3.5.2**.

Table 2.3.5.2: Capacity / production data of Phthalic Anhydride (PA)

Company	Capacity	Production data		
		1996-97	1997-98	1998-99
IGPL, Taloja	1,20,000	80,000	70,000	56,000
MPCL, Karnataka	12,000	12,000	12,000	11,100
TCL, Thirumalai	90,000	35,000	24,000	22,000
Asian Paints, Ankleshwar	25,000	18,000	16,000	13,000
Herdillia, Mumbai	10,000	6,000	5,000	4,500
Ambuja, Andhra Pradesh	9,000	closed	closed	2,500

Note: Capacities are as of 1999 – 2000

2.4 Observations and Findings - Industry Survey

This industry survey of the petrochemicals sector brings out the following:

1. Amongst the basic petrochemicals, the olefins (viz. ethylene, propylene and butadiene) are made by cracking of natural gas, C2/C3 fraction of natural gas and naphtha. Currently, 59% of the country's ethylene capacity is based on gas and 40% on naphtha.
2. Use of alcohol as feedstock for ethylene manufacture is declining fast and many units are facing closure. However, alcohol is used to manufacture number of downstream petrochemicals like aldehydes / ketones.

3. The aromatics (benzene, toluene and xylene) on the other hand are produced by number of processes: recovered from pyrolysis gasoline (during naphtha cracking) as recovery products from coke oven gas and by reforming naphtha. The refineries account for 48 %, whereas crackers account for 42 % of total Benzene production. There have been rapid increases in p-xylene production capacity due to capacity enhancement of synthetic fibres.
4. Natural gas results in higher yields of ethylene compared to other olefins. Naphtha on the other hand gives a wider range of output products (including propylene, butadiene derivatives).
5. There are no manufacturers of ethyl benzene, styrene monomer and methylene di-isocyanate in the country. Also, 2-ethyl hexanol and butanol is also not been manufactured at NOCIL.
6. It can be observed that the downstream petrochemical industry is widely dispersed, manufacturing wide range of products of varying capacities and employing differing technologies.

Chapter –3 MANUFACTURING PROCESS

3.0 UNIT PROCESS

Cracking and reformation are two main unit operations involved in the manufacturer of Petrochemicals.

(A) Cracking

In cracking a hydrocarbon molecule is fractured or broken into two or more smaller fragments. There are three principal types of cracking: thermal cracking, catalytically cracking and hydro cracking.

Thermal cracking for fuel production is performed by subjecting a feedstock to temperature usually in excess of 455°C and at above atmospheric pressures with the objective of converting a residual crude fraction or a heavy distillate into gasoline and light distillate.

Catalytic cracking is performed in presence of a catalyst at temperature between 455°C- 540°C and at above atmospheric pressure. The process converts a distillate feedstock in to gasoline as the primary product with production of light hydrocarbons.

Hydro cracking process operates at elevated pressure in the presence of hydrogen and catalyst at temperature generally less than 432°C.

(B) Reforming

The purpose of reforming naphtha is to rearrange or reform the molecular structure of hydrocarbon, particularly with the objective of producing aromatics. The chemical processes involved in reformation are as follows:

- Dehydrogenation of naphthenes to aromatics
- Dehydrocyclisation of paraffins to form aromatics
- Isomerisation of paraffins to more highly branched isomers

As the reaction proceeds the reformed products will contain increasing concentration of aromatics and decreasing concentration of heavy paraffins. These reforming reactions are regulated by metal catalysts in an environment of hydrogen under moderate pressure.

The manufacturing process of important primary and intermediate products, are described below.

3.1 Ethylene/Propylene

Ethylene and propylene are produced by thermal cracking of hydrocarbons. A process flow diagram for a plant producing ethylene from naphtha and or natural gas is shown in **Fig. 3.1**. Naphtha and/ or natural gas, diluted with steam, is fed in parallel to a number of gas or oil fired tubular pyrolysis furnaces. The fuel for these furnaces is supplied from gas and oil fractions recovered from the cracked gas in later separation stages i.e. ethane and propane. Ethane and propane, which are present in the cracked gas, are separated in later distillation steps, are mixed and recycled through a separate cracking furnace. The flue gas from this pyrolysis furnace is being emitted through furnace stack.

During this operation, coke accumulates on the inside walls of the reactor and each furnace are periodically taken out of service for removal of the accumulated coke. Present day, plants de-coked by on-line i.e. by passing steam and air through the coil while the furnace is maintained at an elevated temperature, effectively burning the carbon out of the coil. While a furnace is being de-coked, the exhaust is diverted to an emission control device (Vent A in **Fig. 3.1**) whose main function is to reduce particulate emissions.

The cracked gas leaving the pyrolysis furnace is rapidly cooled (oil) to 250 to 300°C and steam is generated. The gaseous streams are then further quenched by the injection of recycled pyrolysis fuel oil from the gasoline fractionators. The quenched cracked gas passes to the gasoline fractionators where pyrolysis fuel oil is separated. Most of the fuel oil is cooled and recycled to the oil quenching operation. The surplus fuel oil passes to the stripper, where light fractions are removed, and then it is send to fuel oil storage. The light fraction removed in the fuel oil stripper is recycled to the gasoline fractionators.

The overhead stream from the gasoline fractionators passes to the water quench tower, where C₅'s and heavier compounds are separated. Most of the water separated in the quench tower, is cooled and recycled to the quench tower. Part of the water is passed through dilution steam generators to generate steam and bleed outside as effluent.

On leaving the water quench tower, the pyrolysis gas is compressed to about 3.5 kPa in five stages. Water and organic fractions condensed during compression and cooling are recycled to the quench tower and gasoline stripper, respectively. Following compression, acid gas (H₂S and CO₂) is removed by absorption in diethanolamine (DEA) / other similar solvents in the amine wash tower (amine treator) followed by a caustic wash (caustic scrubber). The amine stripper strips the acid gas from the saturated DEA and the DEA is recycled to the amine wash tower. The waste caustic solution & blow down from the DEA cycle are neutralized, stripped of acid gas, and removed as liquid waste streams. The acid

gas stripped from the DEA and caustic waste passes to an emissions control device (Vent C) primarily to control H₂S emissions.

After acid gas removal, the remaining process gas stream is further compressed and passed through drying traps containing a desiccant, where the water content is reduced to the low level necessary to prevent ice formation in the low-temperature distillation operations.

With the exception of three catalytic hydrogenation operations, the remaining process involves a series of fractionations in which the various product fractions are successively separated. The de-methaniser separates a mixture of hydrogen and methane from the C₂ and heavier components of the process gas. The de-methaniser overhead stream (hydrogen and methane) is further separated into hydrogen rich & methane rich streams in the low temperature chilling section. The methane rich stream is used primarily for furnace fuel. Hydrogen is required in the catalytic hydrogenation operations.

The de-ethaniser separates the C₂ components (ethylene, ethane and acetylene) from the C₃, and heavier components. Following catalytic hydrogenation of acetylene to ethylene by the acetylene converter, the ethylene –ethane split is made by the ethylene fractionators. The overhead from the ethylene fractionators is removed as the purified ethylene product, and the ethane fraction is recycled to the ethane /propane cracking furnace.

The de-ethaniser bottoms (C₃ and heavier compounds) pass to the de-propanizer where a C₃-C₄ split is made. The de-propaniser overhead stream (primarily propylene and propane) passes to a catalytic hydrogenation reactor (C₃ converter), where traces of propadiene and methyl acetylene are hydrogenated. Following hydrogenation, the C₃ fraction passes to the propylene fractionators, where propylene is removed overhead as a purified product. The propane is recycled to the ethane / propane pyrolysis furnace.

The C₄ and heavier components from the de-propaniser pass to the de-butaniser, where a C₄ – C₅ split is made. The overhead C₄ stream is removed & may be treated as follows:

- For recovery of butadiene (IPCL Vadodara, HPL Haldia, NOCIL)
- Hydrogenation in Catalytic Hydrogenation Unit to form Butane with / without Butadiene extraction (HPL Haldia / RIL, Hazira)
- Used as feed into the ethylene process (RIL Hazira)
- Use as fuel for furnaces in the ethylene process

The stream containing C₅ and heavier component from the debutaniser is combined with the bottoms fraction from the gasoline stripper as raw pyrolysis

gasoline. The combined stream is hydrogenated in the gasoline treatment section. Following the stripping of light fraction, which are recycled to the cracked-gas compressor, the C₅ and heavier compounds are transferred to storage as treated pyrolysis gasoline. This stream contains benzene and other aromatics formed by pyrolysis.

3.2 Butadiene

Butadiene are produced by solvent extraction or extractive distillation process wherein the butadiene is extracted by a solvent viz. acetonitrile, cuprous ammonium acetate (CAA), n-methyl pyrrolidone (NMP), furfural, dimethyl formamide (DMF) or dimethyl acetamide. No single solvent has dominated the process worldwide and this suggests that there are no significant differences in both operation and economics using most of these solvents. The solvents used in India are Acetonitrile (NOCIL, TTC) and N-Methyl pyrrolidone (IPCL, Vadodara & HPL, Haldia).

A simplified process flow diagram is presented in **Fig 3.2**. The C₄ stream is first taken for feed preparation, where oxygen if any present in it is removed from feedstock by washing with sodium nitrite solution. Washing solution is then distilled to remove C₃ hydrocarbons, which are sent back to cracker. The vapour phase mixed C₄ hydrocarbons are then contacted and absorbed in the solvent, where butanes & butenes remain largely unabsorbed and are removed as C₄ raffinates. The solvent rich in butadiene is distilled to further remove C₄ raffinates. The butadiene along with traces of butene, acetylenes & 1-2 butadiene is removed with the solvent. The solvent is then taken to a stripper where the gaseous phase containing butadiene, butane, acetylene etc is stripped off. The gases are then re-extracted with solvent in a second extraction column. The solvent is then distilled off to remove butadienes, which are then taken further for purification by fractionation. The propynes are separated during butadiene purification. The solvent from stripper & from second-stage extractive distillation column are taken for solvent recovery and then re-used.

The difference in the processing of butadiene lie in the way the solvent is treated for recovery e.g. CAA (Cuprous ammonium acetate) is passed through carbon adsorbers to remove polymers prior to its reuse. Acetonitrile bleed is diluted with water, polymers allowed to separate as oil in coalescer & acetamide/ ammonia removed in a solvent recovery column by distillation. In the NMP process, solvent is regenerated on a continuous basis in vacuum evaporation vessels to remove polymeric solids.

3.3 Ethylene oxide

Ethylene oxide is produced by continuous direct oxidation of ethylene over a silver catalyst. Either air or pure oxygen can be used as the oxidant for the process. The air oxidation process has higher ethylene consumption, higher carbon dioxide production and produces large amounts of off-gas. The oxygen process requires high energy in production of oxygen but allows the recovery of pure CO₂ that can be re-used (e.g. for inerting) or sale. However, worldwide there appears to be a trend towards the use of oxygen. In India, all EO plants are based on oxygen and this process is described below.

In the direct ethylene oxidation process, reactions take place in the vapour phase. The two main reactions are:

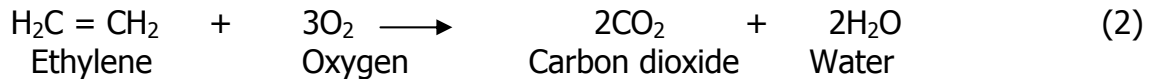
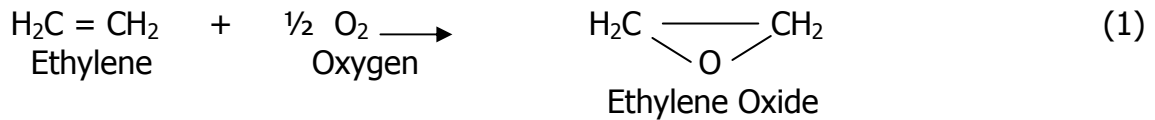

The formation of 25 to 30 percent of the ethylene to carbon dioxide and water, as given in Reaction (2) is major drawback of the oxidation process. Reaction (2) also releases thirteen times as much heat energy as does Reaction (1). Reaction (2) can be suppressed by replacing the catalyst regularly and by carefully controlling the temperature on the surface of the catalyst, thereby limiting the conversion of ethylene to CO₂ and H₂O on each catalyst pass to less than 30 percent.

Fig. 3.3 illustrates the basic operations that may be found in the direct oxidation process. The stream and vents shown in **Fig. 3.3** are described below. In the Oxygen oxidation process, ethylene and oxygen (streams 1 & 2) enter the reactor. The reaction takes place over a silver catalyst packed in tubes, the heat from the reaction is dissipated by a jacket of heat transfer fluid. Reaction temperature and pressure are maintained at 220° to 280°C and 1 to 3 MPa The activity of the catalyst can be enhanced by the addition of promoters such as alkali metals or alkali earth metals. Catalyst inhibitors such as Ethylene dichloride are added to suppress conversion of ethylene to carbon dioxide while not interfering with the primary reaction. In addition to the main by-product, carbon dioxide, small amounts of acetaldehyde (less than 1%) and traces of formaldehyde are also produced.

Descriptions of Streams And Vents Illustrated In Fig. 3.3

Code Number	Description in Fig 3.3
<u>Stream</u>	
1	Ethylene feed, >98 mole percent
2	Oxygen feed, >97-99 mole percent
3	Recycle to primary reactor, 0.006 percent EO
4	Primary reactor product gas, 2 percent EO
5	CO ₂ purge stream
6	CO ₂ -free recycle to primary reactor
7	CO ₂ -rich CO ₂ absorbent (KHCO ₃)
8	Reactivated CO ₂ absorbent (KHCO ₃)
9	Absorber bottoms, minor EO levels
10	Recycle water to absorbers
11	Reabsorber Vent
12	Recycle Water to Reabsorber
<u>Vent</u>	
A	CO ₂ desorber vent (CO ₂ , purge)
B	Inert Purge
<u>Effluent</u>	
E1	CO ₂ absorbent
E2	Water stripped during EO purification

The effluent from the reactor (stream 4) contains Ethylene oxide, Ethylene and carbon dioxide. It is cooled, compressed, and passed through the primary absorber. As it passes up the packed column absorber counter current to cold water, the ethylene oxide and some of the carbon dioxide, hydrocarbons and aldehydes dissolve in the water.

Most of the unabsorbed gas that exits the top of the absorber is cooled and becomes the recycle stream (stream 3). A smaller portion of the unabsorbed gas stream (stream 5) is purged to prevent the accumulation of inert gases such as CO₂ and Argon (which is present as an impurity in oxygen). The purge gas is passed through a CO₂ absorber, which uses potassium carbonate as an absorbent, then (as stream 6) joins the recycle to the reactor. The spent

potassium carbonate (stream 7) is reactivated in the CO₂ stripper, then recycled to the CO₂ absorber (stream 8). The CO₂ is vented from the CO₂ stripper (Vent A). A vent stream (Vent B) is taken from the recycle gas in order to reduce the build-up of inerts like ethane, argon & nitrogen, impurities present in the ethylene & oxygen feedstock. The inerts vent is typically used as fuel gas & burned (e.g. in cracker furnace or steam boiler) & or flared (IPCL, Dahej)

The dilute aqueous solution of EO from the absorber are taken to a stripper, where EO and dissolved inert are distilled under reduced pressure. The stripper water virtually free of EO is re-circulated to the absorbers (stream 10). The crude EO from the desorber is then reabsorbed in water. The EO from the re-absorber is sent for refining/purification. The off-gas from the re-absorber (stream 11) contains large quantity of ethylene and is recycled back to the oxidation stage. The final product 99.5 mole percent EO is stored under nitrogen pressure.

3.4 Ethylene Glycol

The crude EO from re-absorber/purified EO product is hydrolysed with water in a pipe reactor. The large amount of excess water is removed in a multiple effect evaporator. The water removed from the evaporator (stream 13) is used back in MEG reactor. The Ethylene glycol is then taken to a MEG Column where MEG is separated from higher glycols. The column bottoms (containing higher glycols) are further taken for separation of di-ethylene glycol and tri-ethylene glycol column residues are sold as heavier glycols/polyethylene glycols. **Fig 3.4** presents the block flow diagram of Ethylene glycol manufacture and present. Stream descriptions of vents and stream in Fig 3.4 is given below:

Code Number	Description in fig 3.4
Stream	
13	Recycle water to MEG Reactor
14	MEG with trace moisture
15	Higher glycols streams (containing DEG/TEG/Polymeric glycols)
Effluent	
E3	Water removed during evaporation & drying of EO
E4	Water from vacuum system (MEG/DEG)

Various chemical reactions taking place during EO/EG manufacture are listed below:

Product Reactions

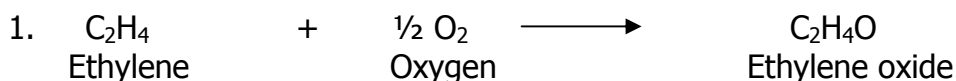

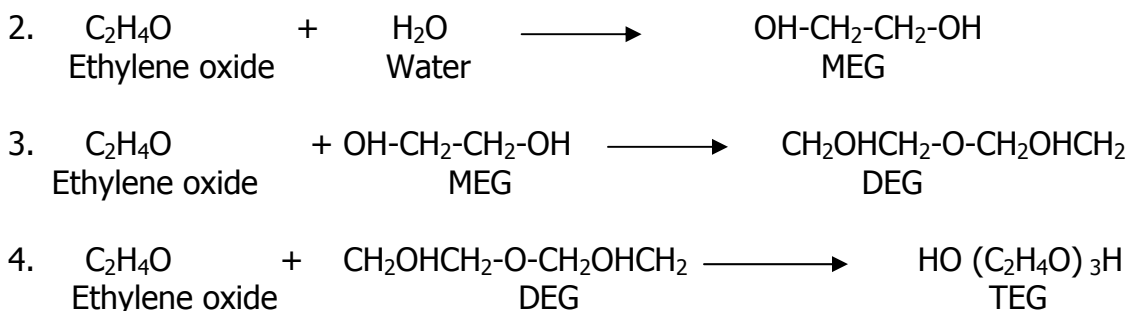

Side Reactions

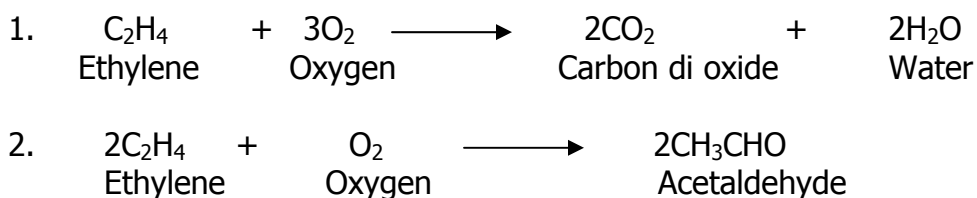

3.5 EDC & VCM

Ethylene dichloride (EDC) is an intermediate product used primarily in the manufacture of Vinyl chloride. The process consists of a direct chlorination operation, a cracking / pyrolysis operation (for hydro-de-chlorination of EDC to VCM), an oxy-chlorination step (for utilising HCl removed in hydro-de-chlorination stage), product finishing and waste treatment operations. The raw materials for the direct chlorination process are chlorine and ethylene. Oxy-chlorination involves the treatment of ethylene with oxygen and HCl. Oxygen for oxy-chlorination generally is added by feeding air (IPCL, Vadodara) or purified oxygen (all other plants in India) as feed material.

Basic operations that are used in a process using air for the oxy-chlorination steps as in IPCL, Vadodara are shown in **Fig. 3.5**

In the direct-chlorination step of the balanced process, equimolar amounts of ethylene and chlorine are reacted in EDC, which acts as liquid medium in a high temperature chlorination reaction (HTC). Most commercial plants carry out the reaction in presence of ferric chloride catalyst. The reaction mass (in vapour form) is quenched in quench column and distilled in distillation column for EDC separation. The vent from the EDC column is treated in caustic scrubber before releasing any un-reacted gases/products to atmosphere (vent A). The heavy ends from distillation column are taken to incinerator. The dry pure EDC produced is sent to intermediate storage before cracking.

Pure EDC liquid is taken from intermediate storage, preheated and vaporized and sent to pyrolysis furnace where EDC is cracked at 490°C. The cracked gases

containing VCM, HCl and un-cracked EDC are quenched rapidly in quench column. Bottoms are sent to tar still for recovery of EDC & heavy ends are sent to storage. The vapours leaving quench column are fed to HCl column for separation of HCl (as 100%) from column top by propylene-refrigerated condenser. The HCl column bottom containing EDC & VCM is next fed to VCM column to separate VCM product from top, which is dried & taken for storage. The VCM column bottoms are taken to flash distillation column to recover EDC.

In the oxy-chlorination reaction the ethylene, anhydrous hydrogen chloride (generated in EDC cracking) and air are reacted in the vapour phase at 200 to 315°C in either fixed bed or fluid bed reactors. A mixture of copper chloride and other chlorides is used as catalyst.

The products of reaction from the oxy-chlorination reactors are quenched with water, cooled, and sent to a knockout drum, where EDC and water are condensed. The condensed stream enters a decanter, where crude EDC is separated from the aqueous phase. The crude EDC is washed with caustic & taken to light ends column, where the low boiling components (lighter than EDC) are separated. In the entire manufacturing process, number of purification steps for EDC, are seen. This is due to the following:

- The impurities present in ethylene (e.g. propylene / propane) may give rise to number of chlorinated by-products.
- The EDC cracker needs to have highest purity EDC, else may result in coke formation, which has to be periodically removed.
- The chlorinated hydrocarbon residues are difficult to dispose off, hence the aim in the process is to recover maximum amount of useful organics such as EDC before disposal of the heavier.

The oxy-chlorination reaction is carried out in several stages and vapours leaving the last stage are released to atmosphere through caustic scrubber (Vent B).

Chemical Reactions

Reactions in EDC/VCM manufacture are given below:

1. Direct chlorination

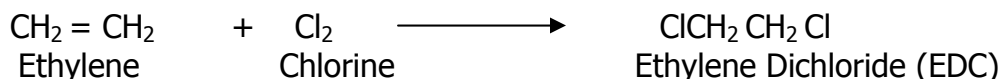

2. EDC pyrolysis

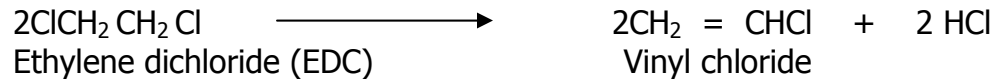

3. Oxy-chlorination

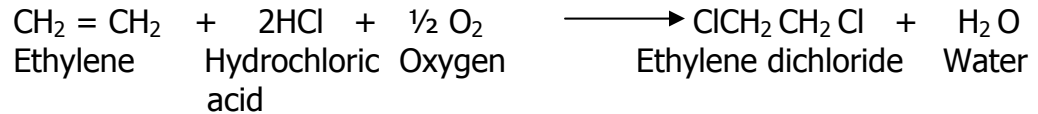

4. Overall reaction

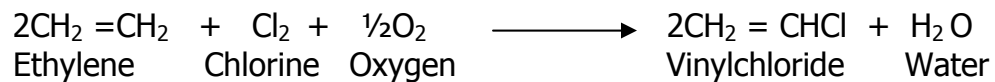

Several by-products like 1,1,2 tri-chloro-ethane, ethyl chloride, chloro-butan-2-ol, chloro-ethylene, ethyl chloride are produced.

3.6 Propylene Oxide \ Propylene Glycol

In the conventional chlorohydrin process, Chlorine and water are fed into the base of a tower reactor where the Hypo-chlorous acid formed reacts with Propylene introduced about half way up the tower. The reaction is exothermic, the heat generated is removed and maintaining the temperature at 30 – 40°C. The effluent gas is scrubbed with Sodium hydroxide before being returned to the reactor. The chloro-hydrin solution formed is hydrolysed to Propylene oxide in a second reactor by treatment with a 10-15% excess of Calcium hydroxide. Liquid from the hydrolyser is distilled and Propylene oxide is recovered overhead and purified by rectification. Calcium chloride is removed as an aqueous waste stream. A portion of the recycle gas is purged to prevent the build-up of Propane in the input feed and to prevent Oxygen from the converted chlorine reaching explosive limits.

In the lummus route, Chlorine is reacted with a tertiary-Butyl alcohol-Sodium hydroxide mixture in brine in a stirred tank to form tertiary Butyl hypochlorite. The effluent from the reactor is allowed to separate into two phases. The organic phase, containing tertiary Butyl hypochlorite. The effluent from the reactor is allowed to separate into two phases. The organic phase, containing tertiary Butyl hypochlorite together with added water, reacts with propylene chlorohydrin and tertiary Butyl alcohol. When Propylene chlorohydrin is saponified with sodium hydroxide, propylene oxide is produced. To minimise by-product formation, propylene oxide is stripped from the alkaline brine solution. Purification of propylene oxide is carried out by rectification.

Tertiary Butyl alcohol is recovered from the bottom stream of the stripper and recycled. The remaining brine solution is treated to remove organics prior to being used in the cell feed.

Reaction

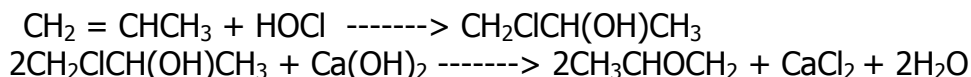

3.7 Iso propyl alcohol

Propylene and water in a fixed ratio is fed in the reactor maintained at 170-190°C and pressure of 30-40 bar. The reaction is carried out in the presence of catalyst incorporating Phosphoric acid on an inert support.

The reaction mixture from the base of the reactor (containing un-reacted Propylene, water, Isopropyl alcohol and di-Isopropyl ether) is cooled and de pressurized. After scrubbing with water, un-reacted Propylene and by product Isopropyl ether are flashed off. Propylene is separated overhead in the Propylene recovery column, compressed and recycled.

Isopropyl alcohol is obtained from the aqueous solution from the bottom of the flash column by distillation. Around 5% of by-product Isopropyl ether is formed during the reaction and this can be recovered from the bottom of the Propylene recovery column by further distillation.

Reaction:

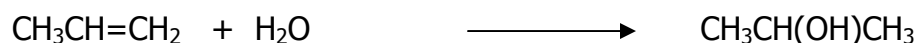

3.8 Acrylonitrile

Acrylonitrile is produced domestically by a single process i.e. Sohio process of propylene ammoxidation. A simplified flow diagram of the basic Sohio process is presented in **Fig. 3.6**.

Propylene, ammonia (NH₃), and air are fed to the reactor in near stoichiometric ratios. A slight excess of ammonia forces the reaction closer to completion and a slight excess of air continually regenerates the catalyst used in the reaction.

The vapour-phase reaction takes place in a fluidised bed reactor in presence of a catalyst. The conversion of propylene in the reactor is essentially complete. The yield of acrylonitrile monomer from this reaction is typically 79 weight percent

with approximately 2 and y molar percent yields of each of the by-products acetonitrile and hydrogen cyanide (HCN) respectively. The stream exiting the reactor contains acrylonitrile and by-products but also un-reacted oxygen, carbon monoxide, carbon dioxide, and nitrogen.

The propylene ammoxidation reaction generates substantial quantities of heat, which must be removed. Heat removal from the product stream is generally accomplished by utilizing excess heat to generate steam in a waste heat boiler. The cooled product stream leaving the waste heat boiler passes to a quench tower followed by scrubber, where un-reacted ammonia is scrubbed by using sulphuric acid.

The quenched product stream is passed to a counter-current absorber, which removes acrylonitrile, acetonitrile, HCN in solution form. The unabsorbed gases are vented to atmosphere. Acrylonitrile, acetonitrile and HCN are separated in a series of distillation columns.

In the first recovery column, acrylonitrile and HCN are separated from acetonitrile and water. Water is then removed from the acetonitrile in the acetonitrile column and recycled to the absorber. The heavy bottoms from the acetonitrile column (HW1) are discharged to the effluent treatment plant after hot alkali digestion. The acetonitrile by-product may be recovered to 99 percent purity for commercial sale.

The crude acrylonitrile exiting the recovery column is passed to storage facilities and then to a light-ends column where HCN is recovered. The HCN by-product may be further purified to 99 + percent for sales, or maybe incinerated in case of lack of demand. In the final product column, heavy ends are removed (HW2) and incinerated. The acrylonitrile product obtained from the Sohio process has a purity of 99 + percent.

Chemical Reactions

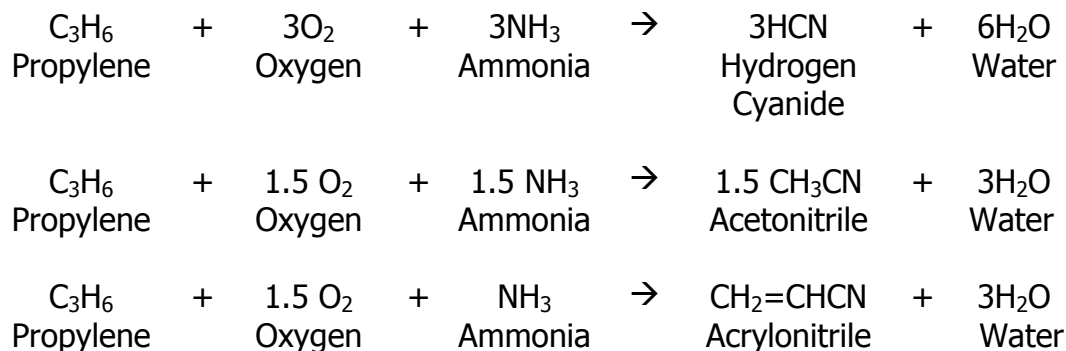

Side Reactions

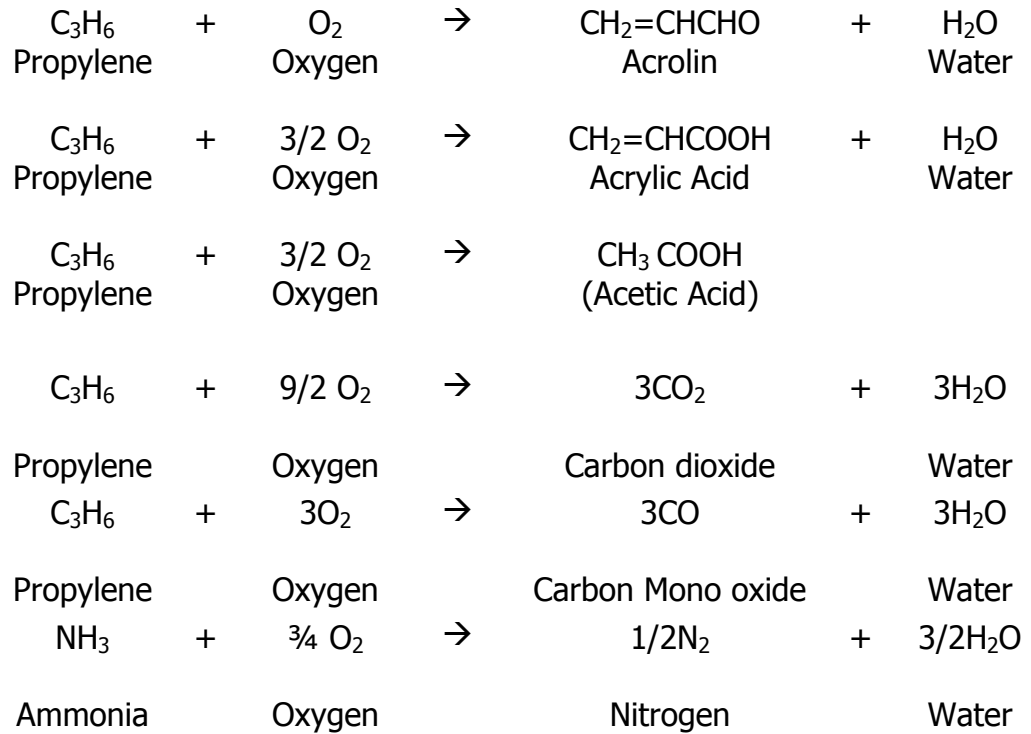

3.9 Benzene and Toluene

Benzene and toluene are produced by variety of processes viz:

1. By extraction / fractionation from Pyrolysis Gasoline
2. Reforming of Naphtha (seen in Petroleum Refineries)
3. Distillation of coke oven light oil (in coke oven plants)

Similarly, benzene can be produced by toluene de-alkylation and disproportionation. As the scope of this study was restricted to petrochemical plants, the processes of Benzene / Toluene manufacture as seen in Petrochemical plants (as side products to manufacture of ethylene) and manufacture by toluene dealkylation / disproportionation are briefly described below:

3.9.1 Manufacture of benzene and toluene from pyrolysis gasoline

The pyrolysis gasoline (pygas) is a stream produced by the high temperature, short residence time cracking of naphtha in petrochemical plants. According to cracking severity, the pygas contains typically 20-40% benzene, 16-20% toluene, 10-13% higher aromatics (e.g. ethyl benzene, xylenes, styrenes etc) with a balance of non-aromatic hydrocarbons (mainly olefins & diolefins)

The benzene extraction from pyrolysis gasoline is carried out in the following steps:

- Hydro-treating
- Secondary Hydrogenation
- Solvent Extraction
- Fractionation

Simplified flow diagram is presented in Fig. 3.7 and each of the process steps are briefly described below:

(a) Hydro-treating

Hydro-treating is the process by which the quality of pyrolysis gasoline stream is improved by subjecting them to mild or severe conditions of hydrogen pressure in the presence of a catalyst. The process flow diagram is depicted in **Fig 3.8**.

The pyrolysis Gasoline feed is heated in a furnace and combined with recycled hydrogen gas. The combined feed is passed through a reactor containing a catalyst bed where the hydrogenation reaction takes place. Upon leaving the reactor, the stream is cooled and moved to a separator vessel where recycle or net hydrogen is removed. The liquid then moves to a stabilizer or stripper, which removes, hydrogen, hydrogen sulfide, ammonia, water and light hydrocarbons, dissolved in the separator liquid.

(b) Secondary Hydrogenation

The pyrolysis gasoline normally undergoes second stage hydrogenation (generally carried out at high temperature -300°C) in which olefins are saturated, organic sulfur forms hydrogen sulfide, combined nitrogen is converted to ammonia, and oxygenated compounds are reduced to hydrocarbons and water. After these parallel reactions have been completed, the gases and liquid are separated. The liquid is then stripped of gaseous impurities, such as hydrogen sulfide and remaining light hydrocarbons.

© Separation of Benzene & Toluene from Hydrogenated Pyrolysis Gasoline

The hydro-treated pyrolysis gasoline is rich in aromatics such as benzene (typically about 40%) and toluene (typically 20%) and has small amount of xylene as well as non-aromatics of similar boiling points. Therefore, separation of these aromatics from other process streams is achieved by

extractive distillation and liquid-liquid extraction. Liquid-liquid extraction is the most commonly used extraction method. If only one aromatic (e.g., benzene, toluene or xylene) is to be recovered in pure form, extractive distillation is preferred as the capital and operating expenses are less than those associated with liquid-liquid extraction.

Liquid-Liquid Extraction

The solvents commonly used in liquid-liquid extraction are sulfolane and tetraethylene glycol. It is adopted by three units in India (Reliance-Hazira, IPCL- Vadodara and NOCIL- TTC). Processes using other solvents such as tetraethylene glycol, di-ethylene glycol, dimethylsulfoxide (DMSO) are not adopted in India. The hydrogenated pyrolysis gasoline stream is fed in the extractor. Where it is contacted with the solvent in the extractor, the non-aromatics (the raffinate phases) leaves through the top while a mixture of aromatics, solvent & light non-aromatics leaves through the bottom. The raffinate is taken to a raffinate wash column where it is washed with water. Raffinate obtained is sent to storage, the bottom is sent to a water stripper. The aromatics / solvent & light non-aromatic stream is transferred from the extractor directly to a stripper. The stripper removes solvent, leaving behind the desired aromatic, which is then sent to a solvent recovery column for recovering the solvent if any. The aromatics phase is passed through a clay tower (to remove olefins) and then taken for fractionation to produce pure benzene & toluene.

Extractive distillation

Extractive distillation methods are preferred when only one aromatic (e.g. benzene, toluene, or xylene) is to be recovered in pure form. Extractive distillation methods separate components by introducing a solvent to a mixture. The solvent suppresses the relative vapour pressure of some components compared to other components in the mixture allowing the desired component to be extracted. Hydro-treated PGH is first processed to remove lighters (less than C₅) and heaviers (greater than o-xylene). The crude BTX stream and the extractive solvent are fed to an extractive distillation column where non-aromatics (the raffinate) are separated. The aromatic/solvent stream is transferred to a stripper, which removes pure Benzene at the top leaving behind solvent, which is reused. Some of the solvents commonly, used in extractive distillation units are di-methyl-formamide, n-formyl-morpholine, n-methyl-pyrrolidone and sulfolane. HPL, Haldia uses n-methyl pyrrolidone to extract benzene from pyrolysis gasoline. The non-aromatics (raffinate) maybe further distilled in a small column to recover any solvent. Thus the extractive distillation is simpler in design comprising primarily of the two columns (one for extractive

distillation / one for stripping). The working pressure in the columns is close to atmospheric or vacuum, the working temperature is about 175°C. Fig. 3.9 presents block diagram for extractive distillation process.

3.9.2 Toluene Dealkylation and Toluene Disproportionation Process

Benzene can also be produced from toluene by hydrodealkylation (HDA) or disproportionation. The amount of benzene produced from toluene depends on the overall demand and price for benzene because benzene produced by HDA costs more than benzene produced through catalytic reforming or pyrolysis gasoline.

a) Toluene Dealkylation

Hydrodealkylation of toluene (HDA process) is accomplished through thermal or catalytic processes. As shown in Fig. 3.10 pure toluene (92 to 99 percent) or toluene (85 to 90 percent) mixed with other heavier aromatics or paraffins from the benzene fractionation column is heated together with hydrogen-containing gas to 730°C at a specified pressure and is passed over a dealkylation catalyst in the reactor. Toluene reacts with the hydrogen to yield benzene and methane. The benzene may be separated from methane in a high-pressure separator by flashing off the methane-containing gas.

The product is then stabilized and benzene is recovered by distillation in the fractionation column. Recovered benzene is sent to storage. Unreacted toluene and some heavy aromatic by-products are recycled. About 70 to 85 percent conversion of toluene to benzene is accomplished per pass through the system, and the ultimate yield is 95 percent of the theoretical yield. Because there is a weight loss of about 23 percent, the difference in toluene and benzene price must be high enough to justify use of the HDA process. Reaction is represented below:

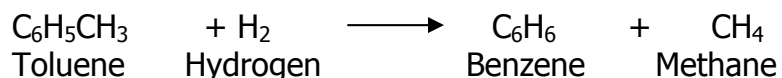

This process is employed by NOCIL, IPCL – Vadodara and HPL - Haldia for conversion of Toluene to maximize benzene yield.

b) Toluene Disproportionation / Transalkylation

Toluene disproportionation (or transalkylation) catalytically converts two molecules of toluene to one molecule each of benzene and xylene. As shown in Fig. 3.11 the basic process is similar to toluene hydro-de-

alkylation, but can occur under less severe conditions. Transalkylation operates at lower temperatures, consumes little hydrogen and no loss of carbon to methane occurs as with HDA. Hydrogenated toluene is sent to a separator for removal of off-gases. The product is then stabilised and sent through clay towers. Benzene, toluene and xylene are recovered by distillation, and un-reacted toluene is recycled. Then HDA is a more economical and feasible process. Reaction is represented below:

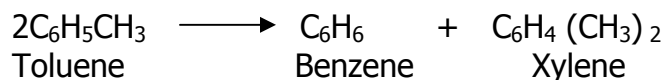

Note that if benzene is the only product required. The TATORY process of UOP is adopted at Reliance, Hazira and Reliance, Patalganga for converting the toluene to benzene and xylene.

3.10 Xylene

Xylenes are produced in Petrochemical Complexes by the following processes:

- a. Reforming of Naphtha
- b. By extraction/fractionation from Pyrolysis Gasoline
- c. Toluene disproportionation /Toluene transalkylation process:

The xylene produced are separated in individual components by separation processes. Also, isomerisation processes are used to increase the yield of particular xylene isomer.

Each of these processes is described below:

3.10.1 Xylene manufacture by naphtha reforming

Two types of processes are observed.

- (1) optimised to produce both ortho-xylene & para-Xylene (IPCL, Vadodara & RIL, Jamnagar)
- (2) optimised to produce para-Xylene only (RIL-Patalganga)

The process adopted for production of both ortho & para-Xylene is described below:

Feed for the processes are petroleum hydrocarbons with boiling range of 105-170⁰C (straight run light naphtha) or hydro cracked naphtha having similar boiling range.

This is carried out in the following reaction steps:

- Hydro-treating
- Reforming
- Separation of mixed Xylene from aromatic streams
- Separation & purification of desired xylene Isomer

Simplified flow diagram is presented in **Fig. 3.12** and each of the process steps are briefly described below:

a) Hydro-treating

Hydro-treating, schematically illustrated in **Fig. 3.13**, is the process by which the quality of naphtha is improved by subjecting it to mild or severe conditions of hydrogen pressure in the presence of a catalyst.

The naphtha feed is preheated, heated in a furnace, and combined with recycled hydrogen gas. The combined feed is passed through a reactor containing a catalyst bed where the hydrogenation reaction takes place. Upon leaving the reactor, the stream is cooled and moved to a separator vessel where recycle or net hydrogen is removed. The liquid then moves to a stabilizer or stripper, which removes, hydrogen, hydrogen sulphide, ammonia, water & light hydrocarbons, dissolved in the separator liquid.

b) Reforming of naphtha to produce BTX rich stream

Reforming is a platinum catalysed high temperature vapour phase process which converts a relatively non-aromatic C₆ -C₁₂ hydrocarbon mixture (naphtha) (typically containing less than 1% aromatics) to an aromatic product called reformate.

The main process units are depicted in **Fig. 3.14** & described below:

- Reactors, which contain fixed bed catalysts.
- Heaters to bring the naphtha and recycle gas to reaction temperature and to supply heats of reaction.
- A product cooling system and a gas-liquid separator.
- A hydrogen-gas recycle system.
- A stabilizer to separate light hydrocarbons dissolved in the receiver liquid.

The naphtha is combined with recycled hydrogen, preheated, heated to the reaction temperature in a fired heater and then transferred to a series of catalyst-containing reactors. Because the reaction is endothermic, a series of three or four reactors with inter-stage reheat furnaces are necessary to achieve the required conversion. The reactors normally contain increasing amounts of catalyst in each stage.

The effluent from the last reactor is cooled and transferred to a receiving unit (e.g., the flash drum) where the hydrogen is separated from the liquid reformat. The hydrogen gases are compressed and recycled to the reactors while the reformat is moved to a stabilizer fractionator. The fractionator removes lighter hydrocarbons (hepton) to produce a stabilized reformat. The stabilized reformat is used as a feedstock for further recovery of benzene, toluene & xylene.

c) Separation of mixed xylene from reformat

The stabilized reformat is then taken for fractionation (ortho-meta splitter). The bottom product is a mixture of o-Xylene & C₉ aromatics. The top product is a mixture of Ethyl benzene, o-,m-,p-Xylene is sent to PAREX for separation of p-Xylene isomer.

d) Separation and purification of desired xylene isomer

Typical mix of xylene isomers from a catalytic reformat stream consists of the following: m-xylene (40 percent), o-xylene (24 percent), p-xylene (19 percent) and ethyl benzene (17 percent). The demand for mixed xylene is low in comparison to the demand for pure isomers, especially p-xylene. Hence, separation of isomers of xylene has to be resorted to. Isolation of individual isomers through conventional distillation is difficult for xylene isomers because of the closeness of their boiling points.

Hence, separation of xylene isomers is generally based on differences in adsorptive properties. In PAREX unit, p-Xylene is selectively adsorbed on the adsorbent. After the bed is saturated, p-Xylene is desorbed by using another organic such as toluene or p-diethyl benzene. The PAREX process adopted at IPCL, Vadodara and RIL Patalganga is developed by UOP and separates the p-xylene isomer using molecular sieves.

e) Isomerisation

The paraxylene lean stream from adsorber (PAREX unit) is heated to reaction temperature & treated with hydrogen to convert ethyl benzene & m-xylene into p-xylene. Top product, which is a mixture of benzene,

toluene & other light hydrocarbons is separated in the stabilizer sent to Gujarat refinery as gasoline blending stock & bottom product is sent back to ortho-meta-splitter.

3.10.2 Xylene production from pyrolysis gasoline

Generally xylene content in pyrolysis gasoline is very low & hence only Petrochemical complexes having very large capacity &/or wanting xylene for downstream uses make xylene from pyrolysis Gasoline. In India, only RIL-Hazira which has a 7,50,000 TPA naphtha cracker makes xylene from pyrolysis gasoline.

The pyrolysis gasoline (pygas) is a stream produced by the high temperature, short residence time cracking of naphtha in petrochemical plants. According to cracking severity, the pygas contains typically 20-40% benzene, 16-20% toluene, 10-13% higher aromatics (e.g. ethyl benzene, xylenes, styrenes *etc.*) with a balance of non-aromatic hydrocarbons (mainly olefins & diolefins)

The xylene extraction from pyrolysis gasoline (pygas) is carried out in the following reaction steps:

- Hydro-treating
- Secondary hydrogenation
- Solvent extraction
- Fractionation

The details are explained in 3.10.1

3.11 Maleic anhydride

The oxidation of benzene is carried out in a fixed-bed reactor in the presence of air. Filtered air is preheated, compressed from a blower and mixed with benzene vapour to give a concentration of 3wt% benzene. It is then fed into multi-tubular reactor containing a vanadium oxide-molybdenum oxide catalyst on an inert substrate, such as alumina. An excess of air is required to keep the vapours outside explosive limits. Silver, cobalt, nickel, titanium and sodium oxide and salts have been used as promoters to increase yields. Heat from the exothermic reaction is removed by molten salts, circulated by a pump, which pass through a heat exchanger to generate high-pressure steam. The reaction temperature is kept at 350-450°C.

The reactor exit gases (containing around 1% maleic anhydride, carbon monoxide, carbon dioxide and traces of phenols and carboxylic acids) are cooled to 55-65°C. About 60% of the maleic anhydride is condensed as a liquid and removed from the vapour stream. It is separated from the gases and sent to the

crude maleic anhydride tank. The remaining gases are scrubbed counter currently with water in an absorption tower. The resultant maleic acid is dehydrated by azeotropic distillation with o-Xylene, and water is removed overhead.

The dehydrated product is combined with the condensed anhydride before being recovered by distillation. Purification of the crude maleic anhydride is carried out by vacuum distillation or sublimation. Maleic anhydride is either sold in the molten state or formed into pellets and flakes and bagged. The block flow diagram is depicted in **Fig. 3.15**.

Reactions:



3.12 Phenol / Acetone / Cumene:

3.12.1 Cumene from benzene and propylene

Chemical grade Propylene or a Propylene cut containing up to 60% of Propane and Benzene are mixed and fed into a reactor, where they are brought into contact with a catalyst consisting of Phosphoric acid supported on Kieselgur or Pumice.

The reactor temperature is kept at 200-250°C with a pressure range of 15-35 bar. An excess of Benzene in the molecular ratio of 5:1 Benzene to Propylene is maintained in order to suppress dealkylation, oligomerization and other side reactions and attain a high conversion rate.

The gases from the reactor are used to heat incoming feed before entering the recycle column where any un-reacted benzene is recovered and recycled. The remainder of the liquid stream is fed into the cumene distillation column where heavy by-products such as di- and tri- Iso-propyl-benzene are recovered as bottoms while pure cumene passes overhead.

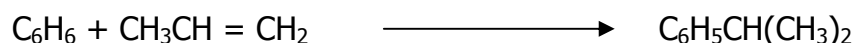

3.12.2 Phenol from cumene by peroxidation

In the peroxidation process, Phenol is obtained by the decomposition of Cumene hydroperoxide, decomposition of Cumene hydroperoxide, derived from Cumene, which in turn is produced from Benzene and Propylene.

In the two-stage process, pure Cumene is fed into an oxidation vessel where it is mixed with a dilute solution of Sodium carbonate. Air is introduced and the mixture, at a temperature of 110-130°C, is left in contact until 25-30% of the Cumene is oxidized to the hydroperoxide. If the conversion is allowed to proceed beyond this point, there is an increased risk of by-product formation. Lower operating temperatures favour the yield of hydroperoxide but conversion is lower.

In the second stage, the crude mixture is concentrated to about 80% Cumene hydroperoxide before being fed in to a cleavage reactor. The reaction is carried out at a temperature of 70-80°C and a pressure of 0.3 bar in the presence of a dilute acid, such as a 10% solution of Sulphuric acid. Both the oxidation and cleavage reactions are very exothermic. Temperature control can be effected either by the evaporation of water which is present or by using cooled resultant mixture to dilute the hydroperoxide. The major reaction products are Phenol and Acetone, with small quantities of Acetophenone, alpha Methyl styrene and Cumene.

The reaction products are separated by distillation. Acetone is flashed from the top of the first column and purified by distillation. The bottoms from the column are further distilled to remove any unreacted Cumene and alpha Methyl styrene. By-product alpha Methyl styrene can be recovered and sold or converted to Cumene by catalytic hydrogenation before being recycled to the first-stage reactor, Further distillation separates by-product Acetophenone from Phenol, which is recovered overhead. The block flow diagram is depicted in **Fig. 3.16**.

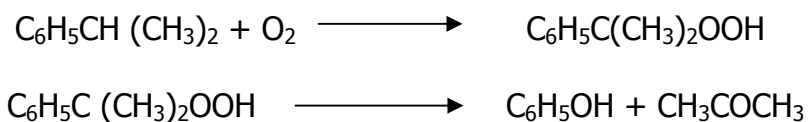

3.13 Toluene di-isocyanate (TDI)

Di-nitro-toluene is produced by continuous nitration of Toluene by a mixture of Nitric and Sulphuric acids. The nitration mixture containing mono nitro-toluene (MNT) is extracted with toluene and separated in a dynamic separator. The toluene containing MNT is further nitrated to obtain di-nitro-toluene. After three stages washing it is continuously hydrogenated in presence of a catalyst at 115°C to produce meta Toluene diamine (MTD). The reaction mixture containing MTD-water-catalyst slurry is removed from hydrogenator and after thickening the catalyst slurry is returned back to the reactor while the filtered MTD water solution is sent for storage. The ortho and para-isomers are separated by distillation and collected as overhead purge and sent for incineration. The MTD with a maximum of 0.25% of ortho isomer is cooled and sent for storage. Phosgene required for converting MTD into TDI is made in situ reacting CO,

generated by controlled burning of coke, with chlorine. MTD dissolved in ODCB (ortho dichloro benzene) is reacted with Phosgene in a pipeline reactor using 100% excess Phosgene. The off-gas containing HCl and Phosgene are separated from the crude TDI - ODCB solution and sent to absorbers for separating Phosgene and HCl. Degasification of TDI - ODCB solution is carried out to remove remaining Phosgene and HCl. The TDI - ODCB is vacuum distilled to recover ODCB. The bottom from primary ODCB recovery column is fed to tar concentrator. The TDI rich and pure TDI, which comes out as process flow, is sent for storage. The schematic of process flow is depicted in **Fig. 3.17**.

Chemical Reaction

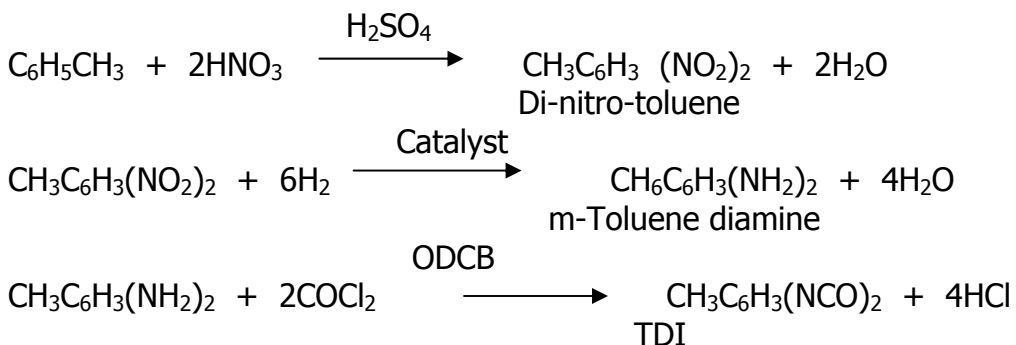

3.14 Phthalic anhydride (PA)

Phthalic anhydride is manufactured by partial oxidation of o-xylene with air in presence of catalyst. Air from process air blower is preheated to 180°C and feed stock o-xylene to 130°C and both are intimately mixed at certain proportion. The air, o-xylene vapour mixture is highly explosive in nature. This mixture is fed to top of fixed bed catalytic reactor where steady catalyst temperature of about 380°C is maintained. Under this condition partial oxidation of o-xylene to phthalic anhydride takes place with evolution of large quantity of heat. The heat of reaction is utilised for captive power generation and also for process heating.

The hot product gas coming out of reactor at around 380°C containing PA and other by-products and excess air is cooled in gas cooler to around 160°C. The gases from gas cooler are fed to oil cooled finned tube type switch condenser. These operate as alternate cooling-heating cycles, whereby during the cold cycle, PA desublimates and deposits on fins. During the heating cycle, hot oil is passed to melt and remove the PA. The gases from switch condenser are subjected to extensive scrubbing with water spray with re-circulation and finally let out through chimney. The PA is subjected to heat treatment in pre-treatment vessel under atmospheric conditions in continuous distillation unit. The preheated PA is led to fore running column, which operates, under vacuum and low cuts are removed from top.

PA is continuously fed to final distillation column, where pure PA is taken as top product. The pure PA is stored in sludge form in a rotating drum, which is cooled by circulating water. The PA solids are taken off and bagged. The block flow diagram is depicted in Fig. 3.18.

3.15 Di-methyl terephthalate

Di-methyl terephthalate is produced by the reaction of paraxylene with oxygen & then with methanol. The oxidation reaction takes place in the presence of catalyst. The Un-reacted paraxylene from oxidation products are stripped completely with steam. The oxidate mixture is then reacted with methanol to produce esters (DMT & Methyl Para toluate). The product esters are then distilled to separate low boiling residue and dibasic acids from DMT. The DMT is further purified by crystallisation to remove impurities like isomers & aldehydes. The purified DMT in the form of pellets is sent to storage. The block diagram of manufacturing process is presented in Fig. 3.19.

Chemical reaction

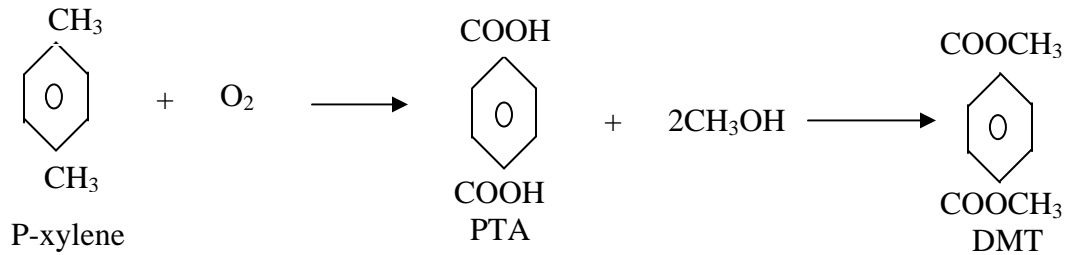

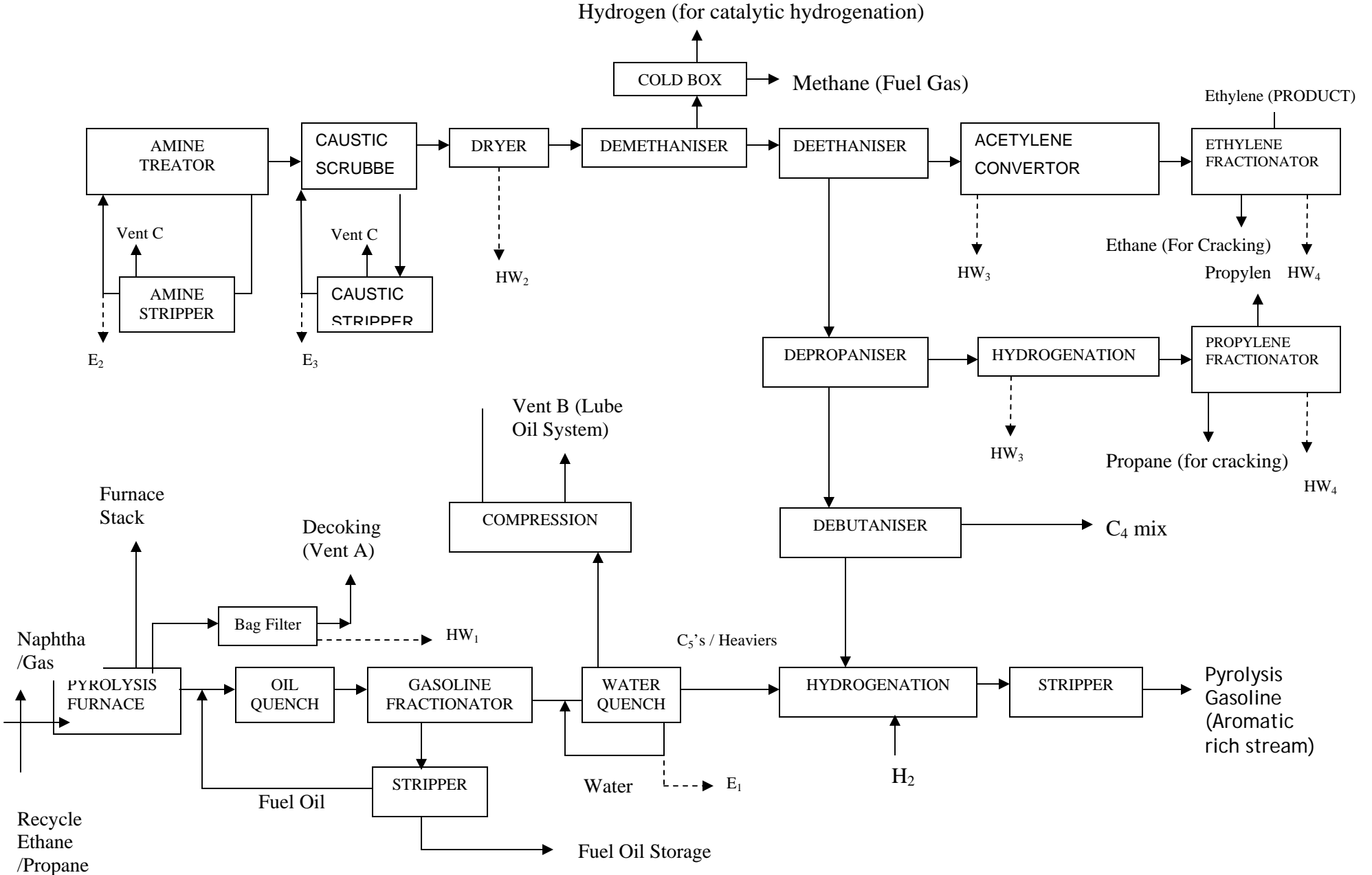

Fig. 3.1- Block Diagram – Olefin Manufacture

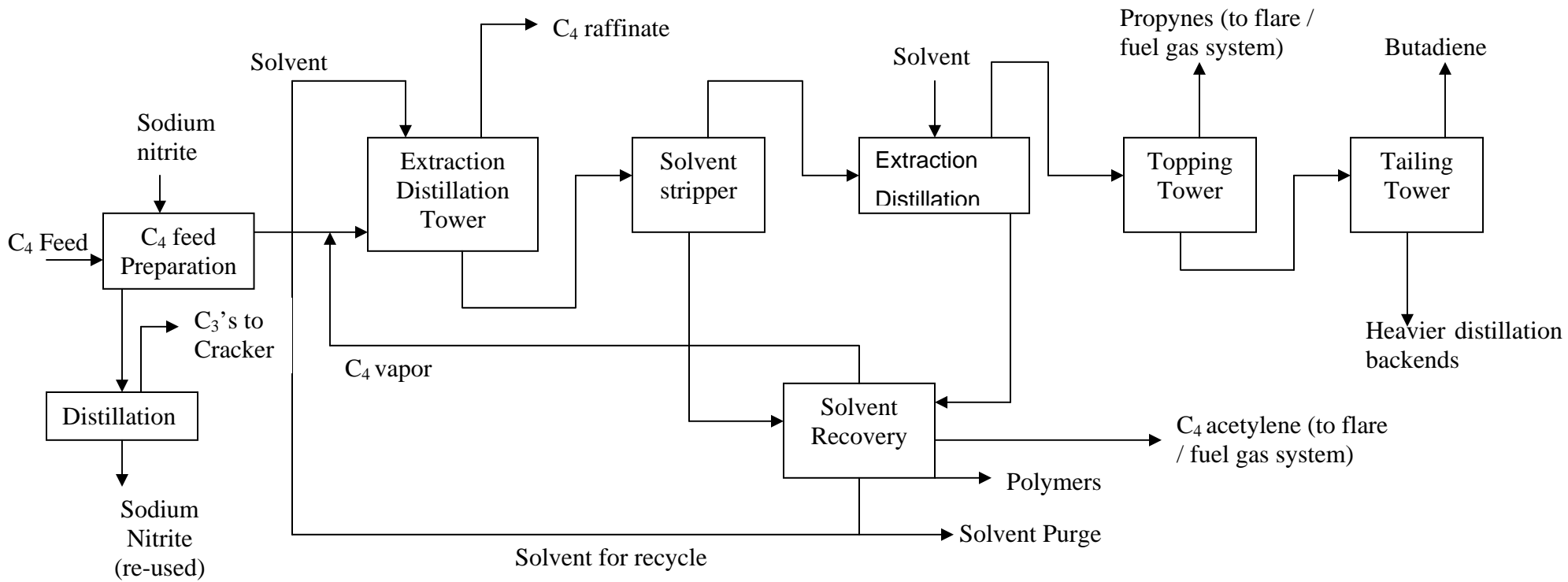

Fig. 3.2 Simplified Flow Diagram – Butadiene Manufacture

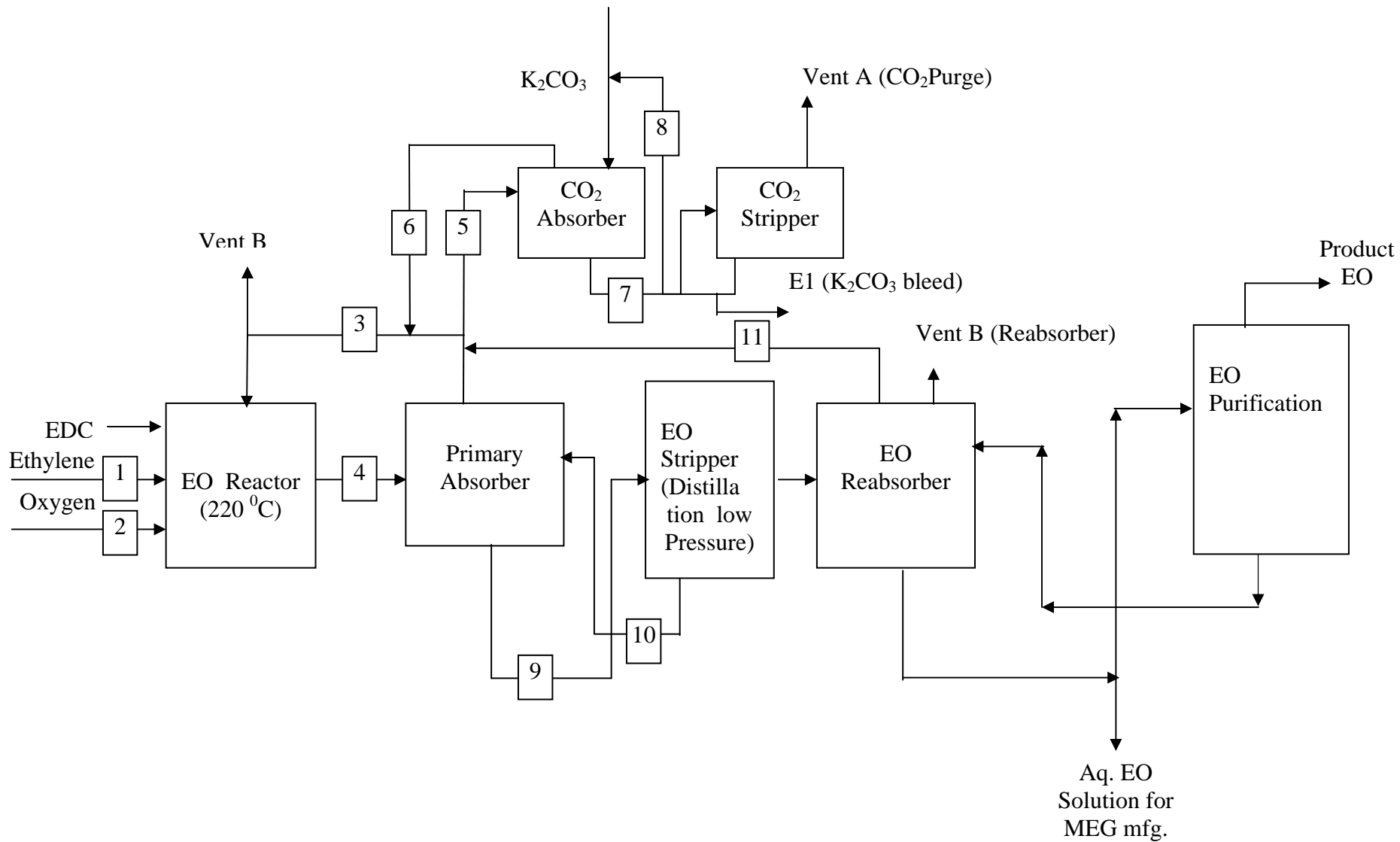

Fig. 3.3: Block Diagram - EO Manufacture

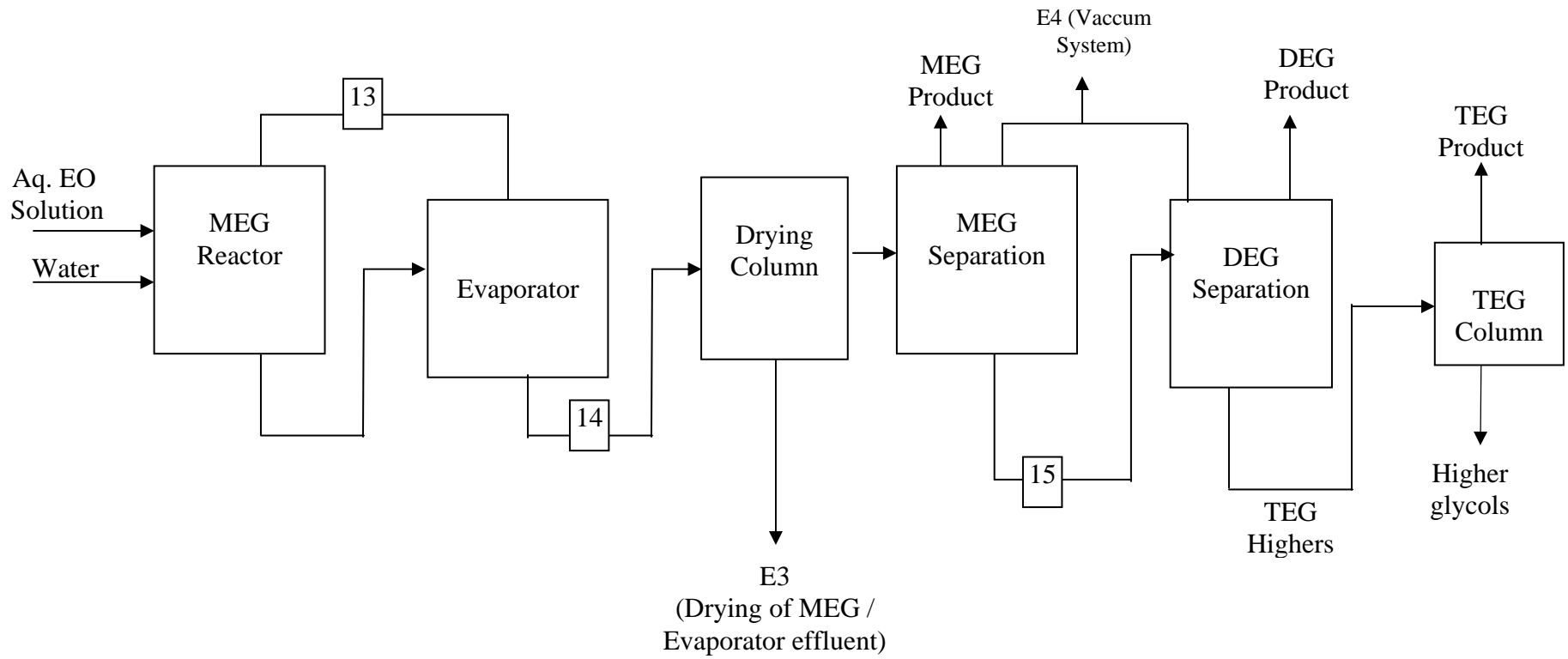

Fig. 3.4: Block Diagram - Glycol Manufacture

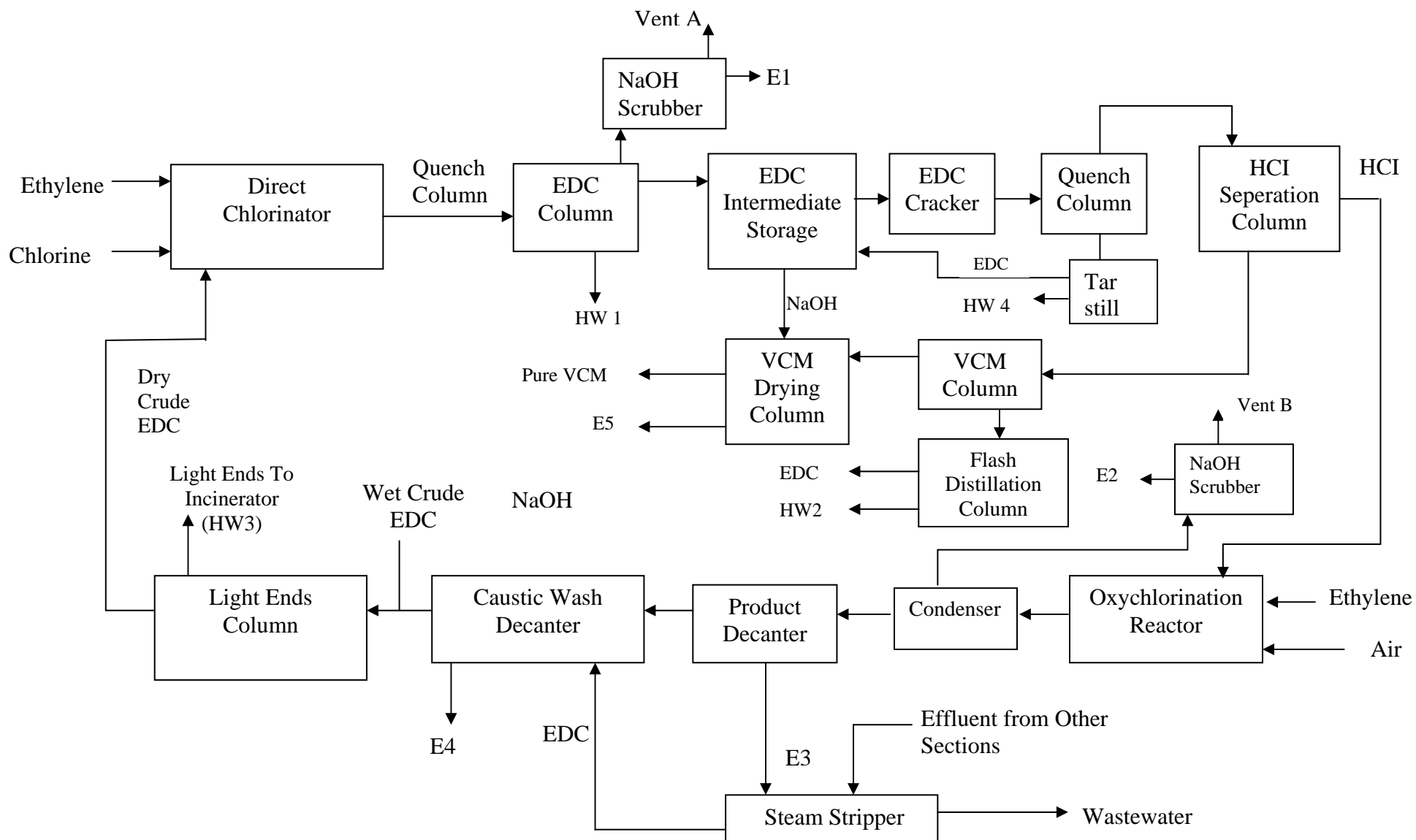

Fig.3.5: Block Diagram - EDC/VCM Manufacture (Balance Process)

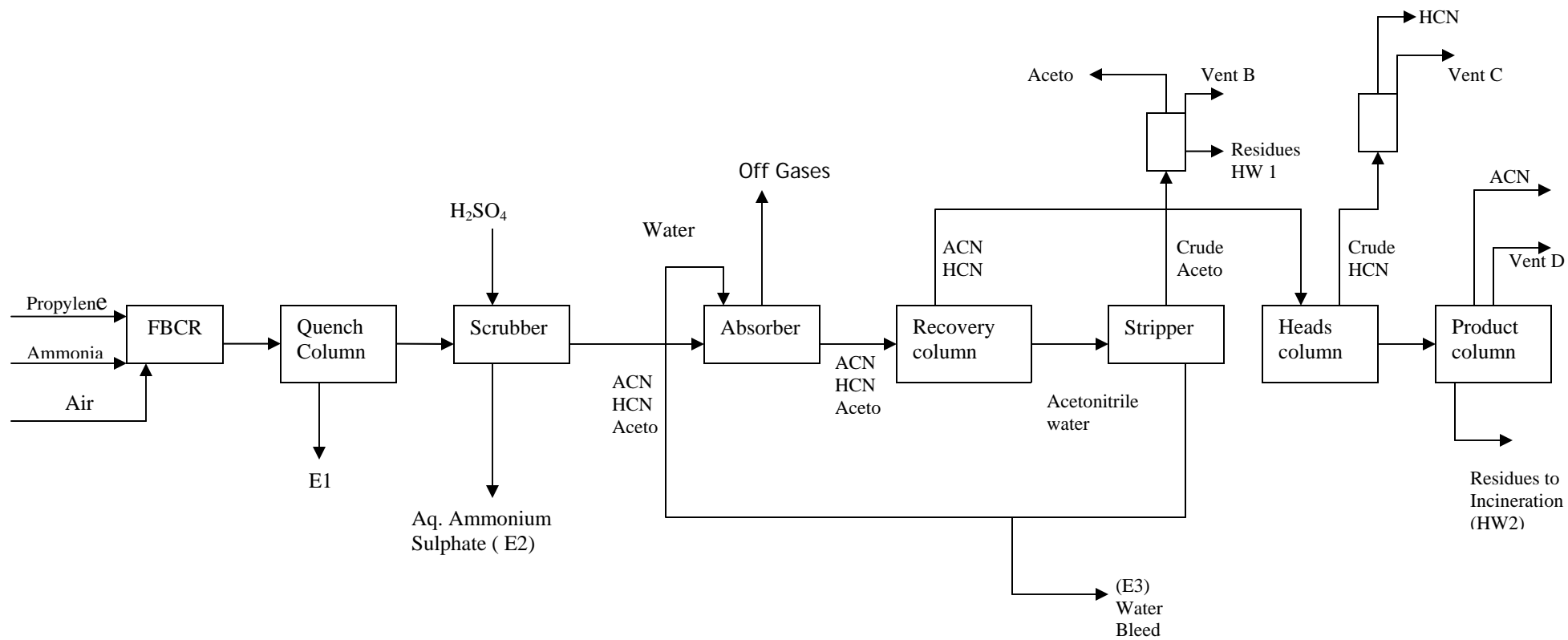

Fig. 3.6: Block Diagram -Acrylonitrile Manufacture

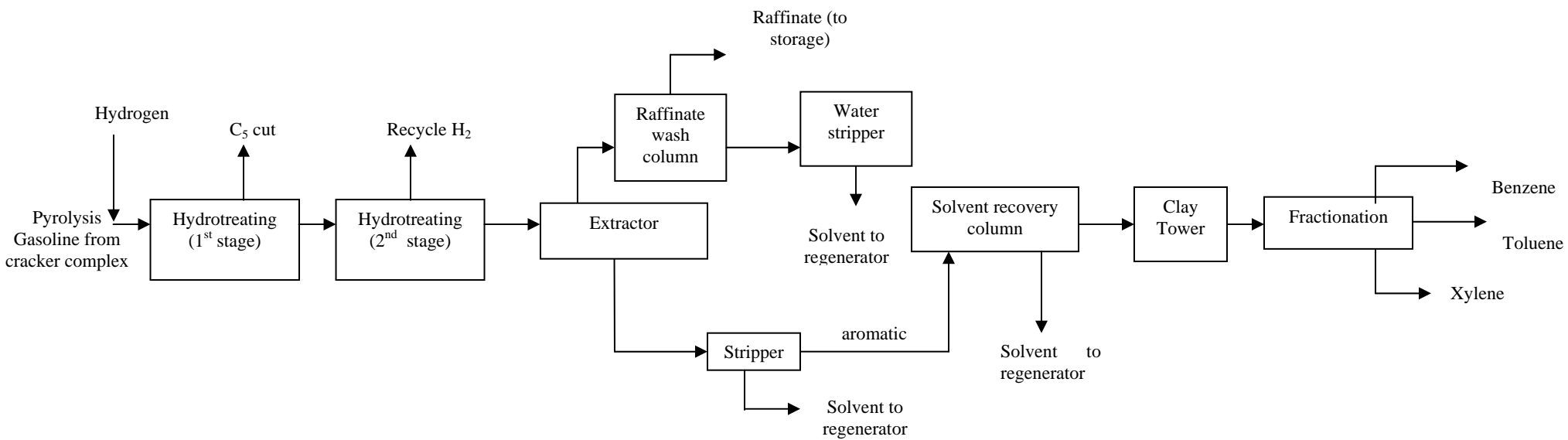

Fig. 3.7 Benzene / Toluene Extraction From Pyrolysis Gasoline (using Liquid – Liquid Extraction)

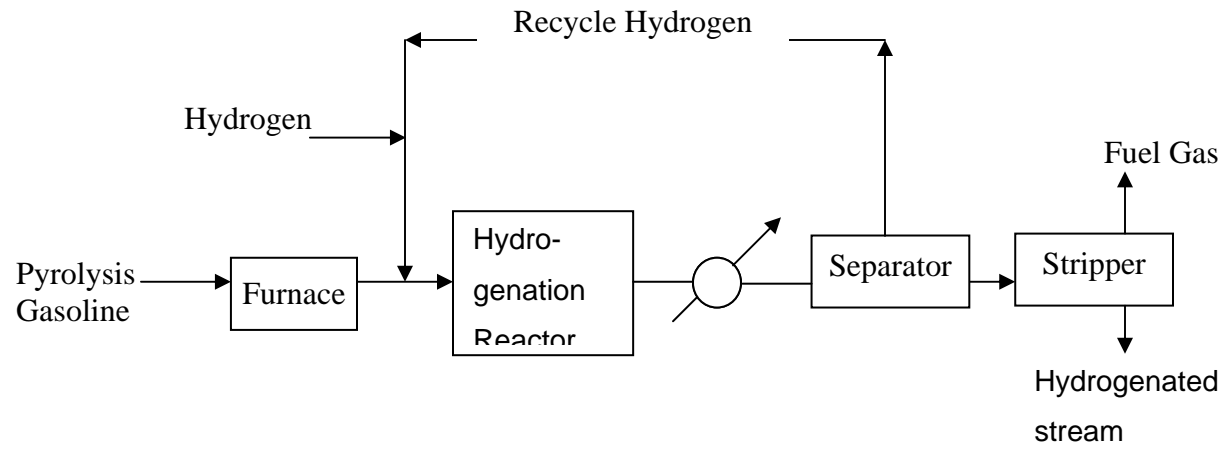

Fig. 3.8: Process flow diagram for hydro-treating

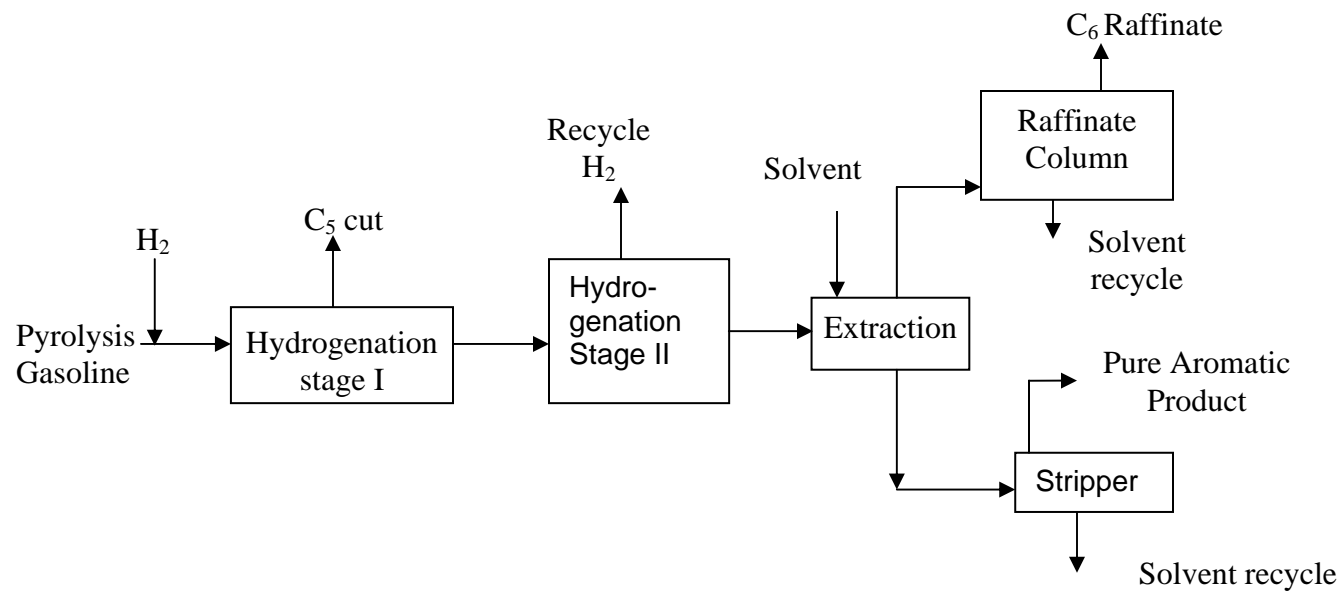

Fig. 3.9: Benzene / Toluene extraction from pygas using extractive distillation

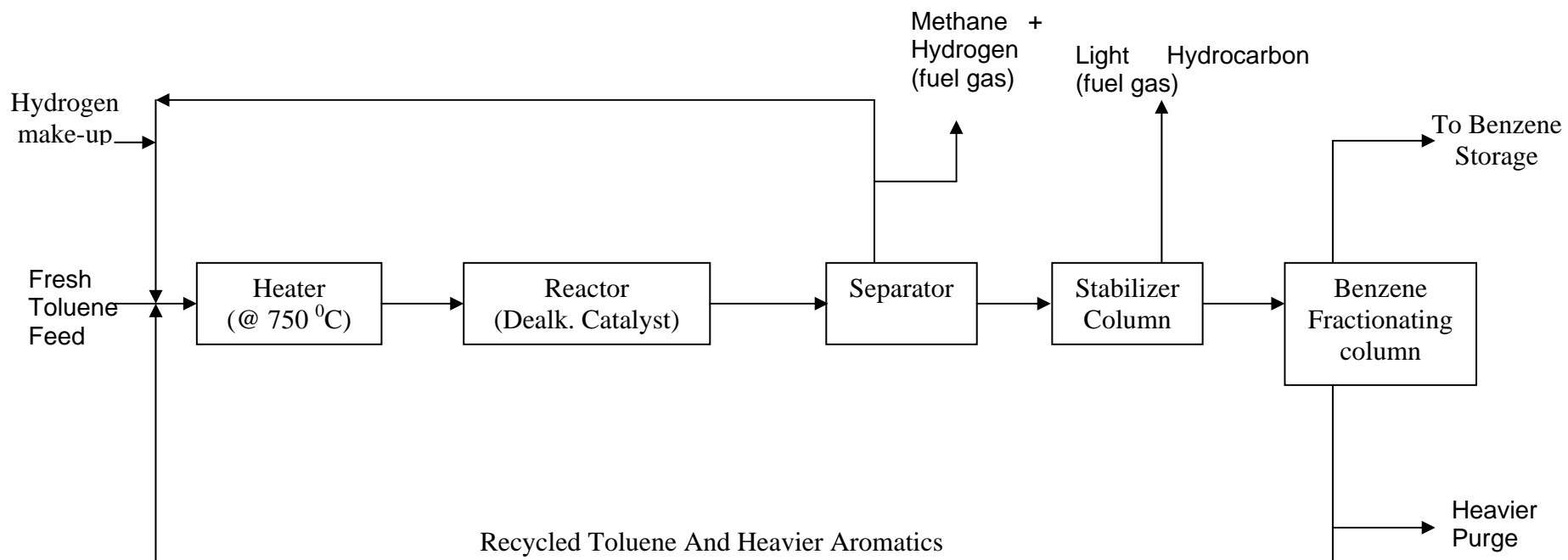

Fig. 3.10: Process Flow Diagram of A Toluene Dealkylation Unit (HDA)

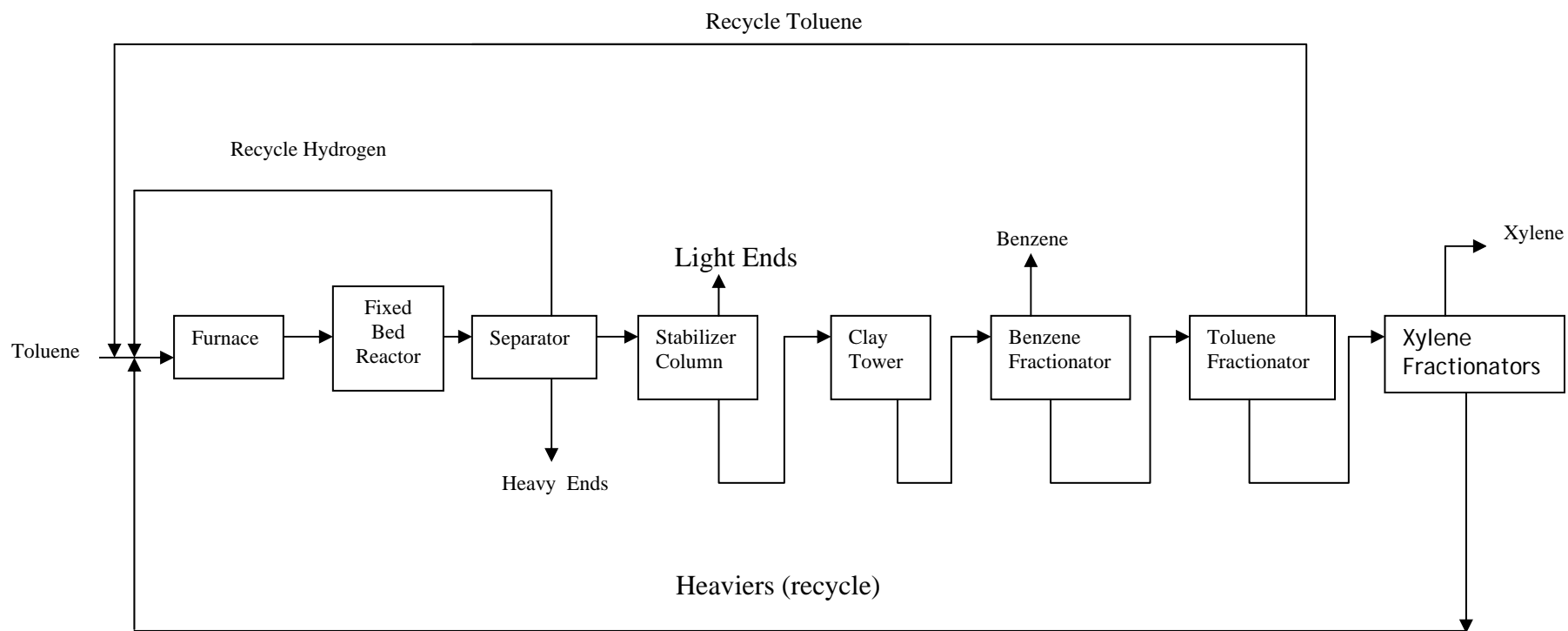

Fig. 3.11 Toluene Disproportionation Process Flow Diagram (Tatoray Process)

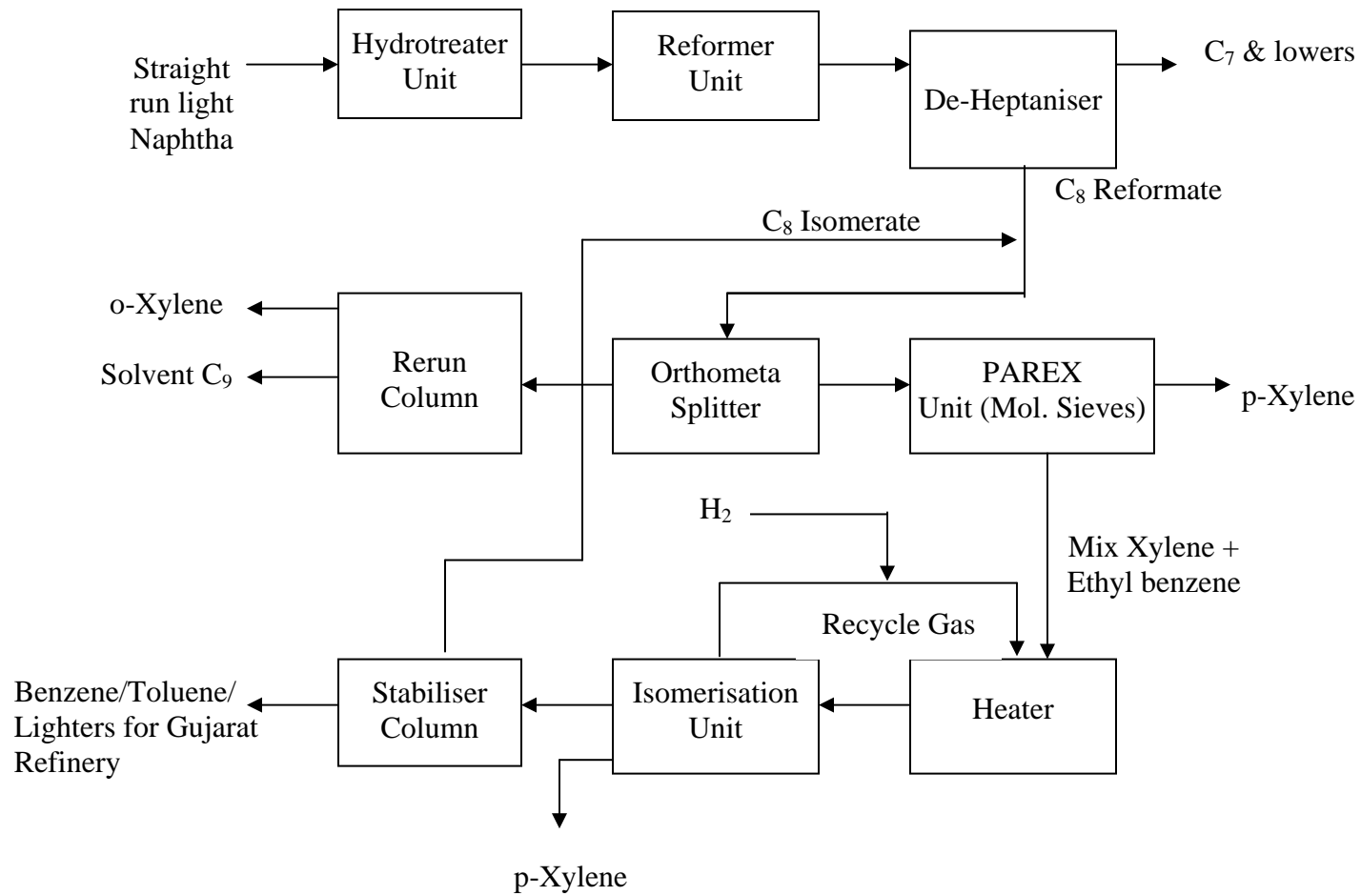

Fig. 3.12 Block Diagram of Xylene Process (IPCL, Vadodara)

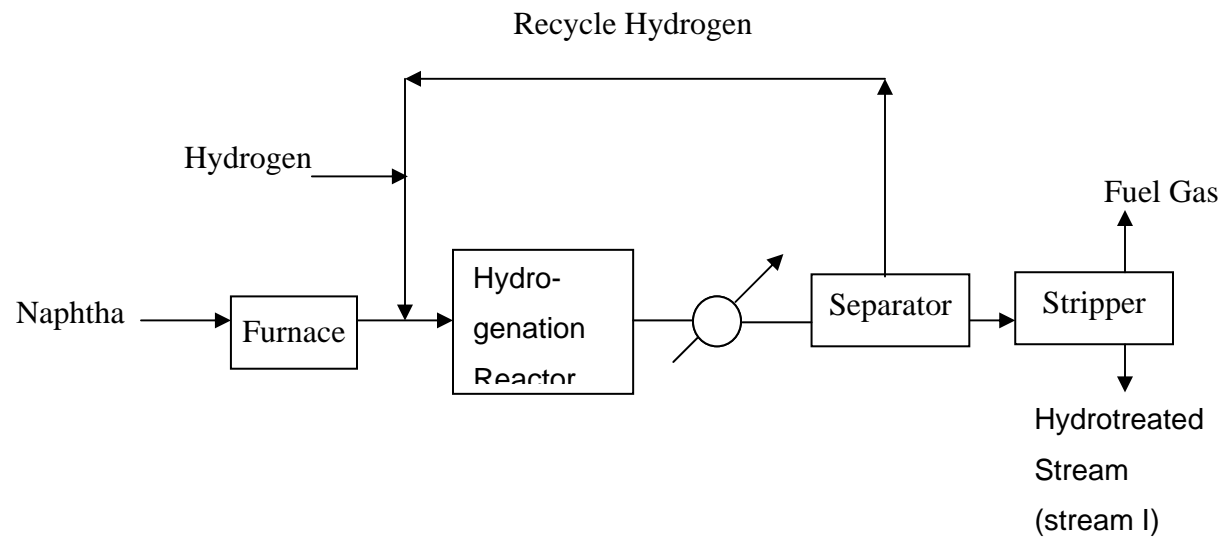

Fig. 3.13: Process flow diagram for hydro-treating

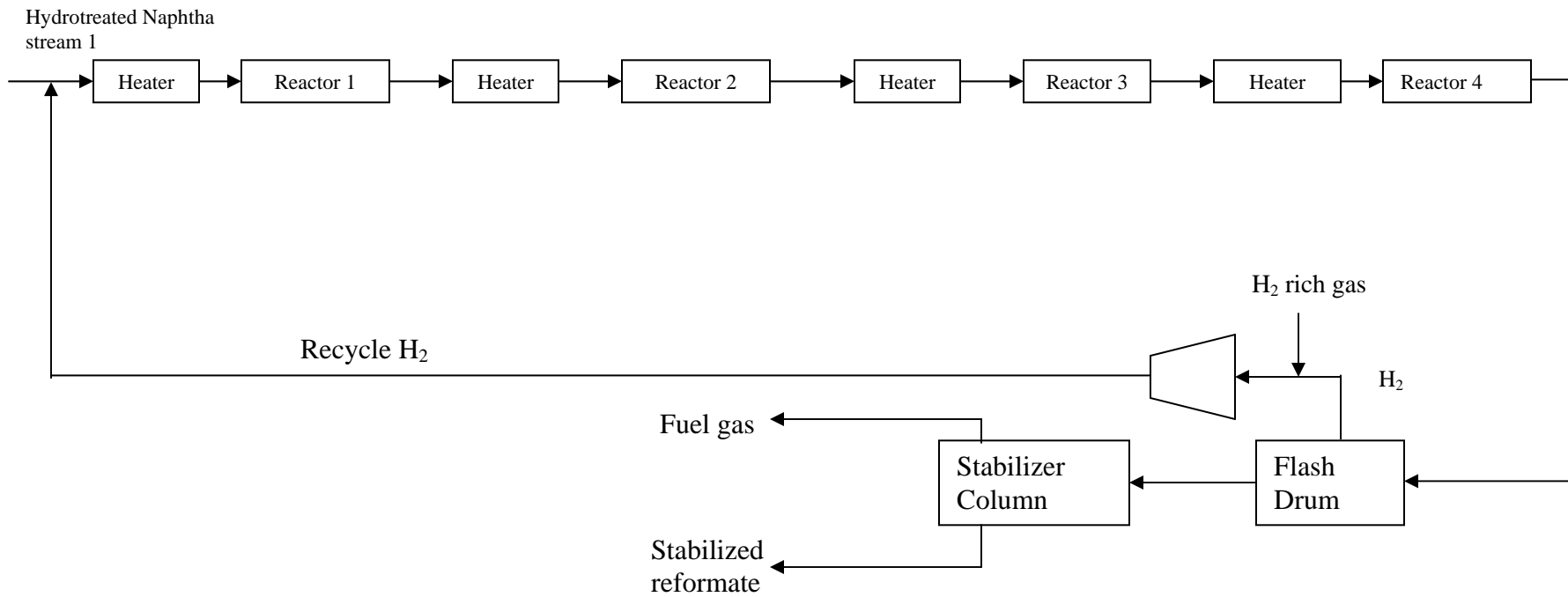

Fig. 3.14: Process Flow Diagram for Reformer Unit.

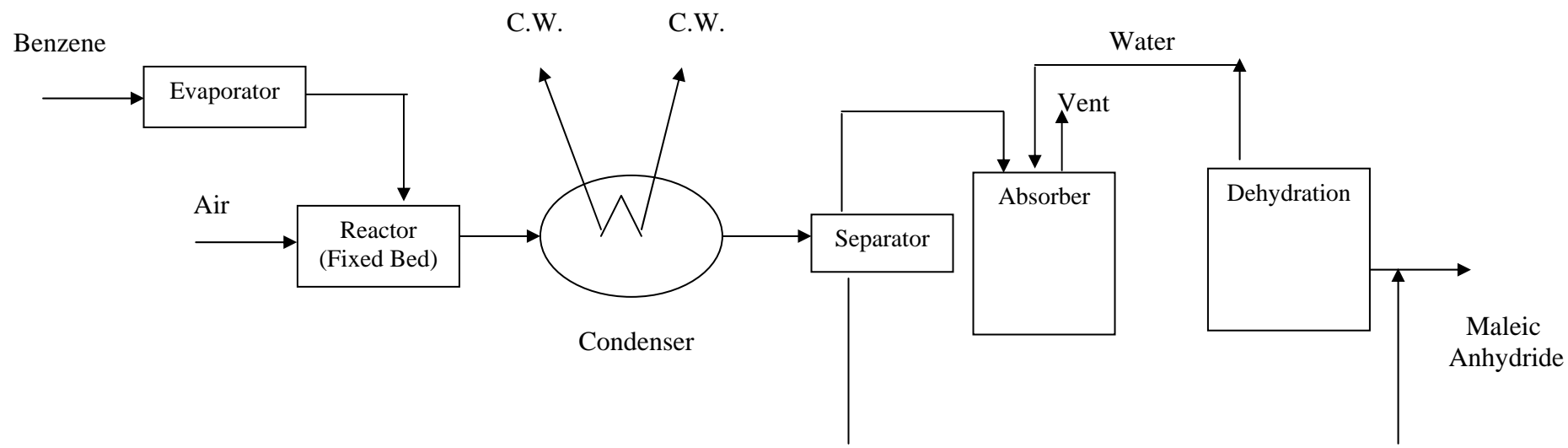

Fig. 3.15: Block diagram for Maleic Anhydride

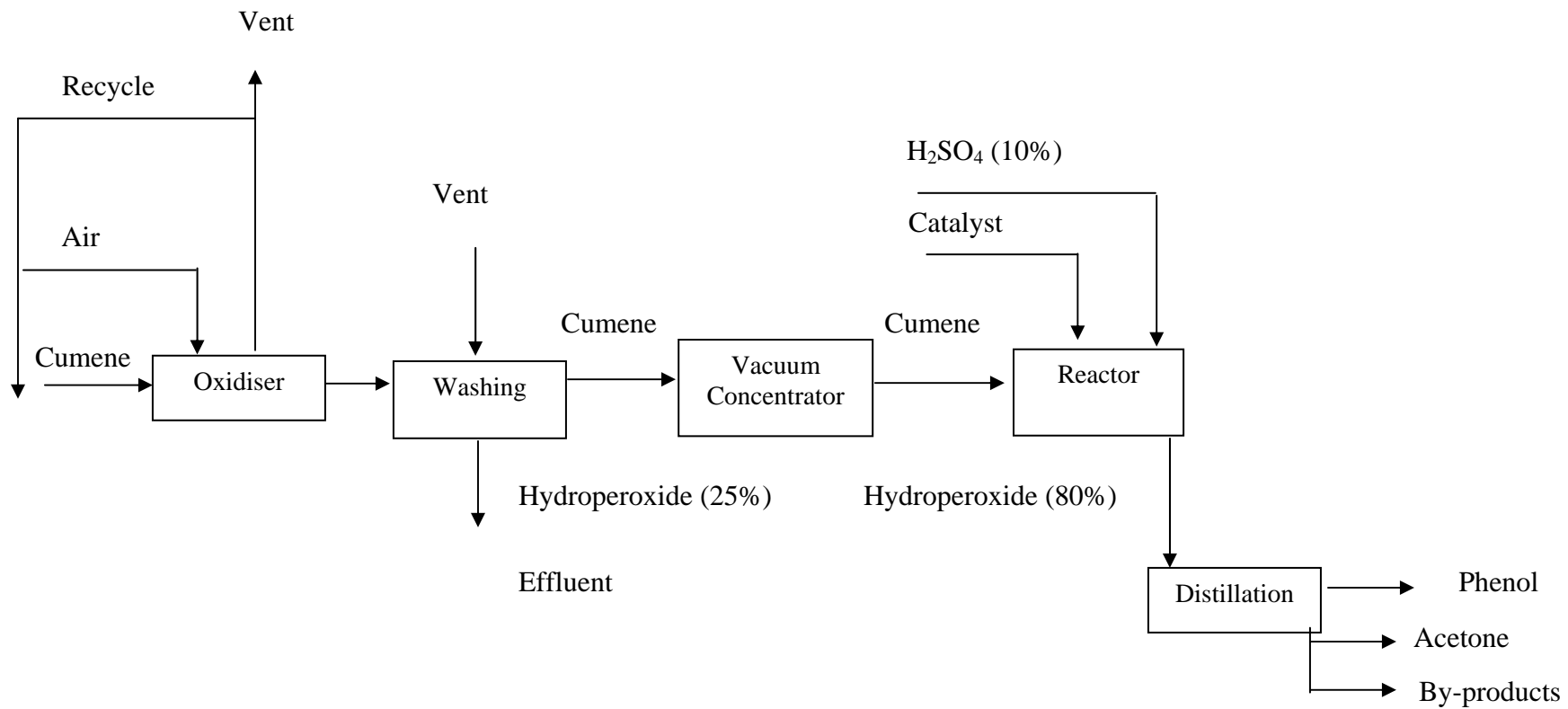

Fig. 3.16: Block diagram for Phenol / Acetone

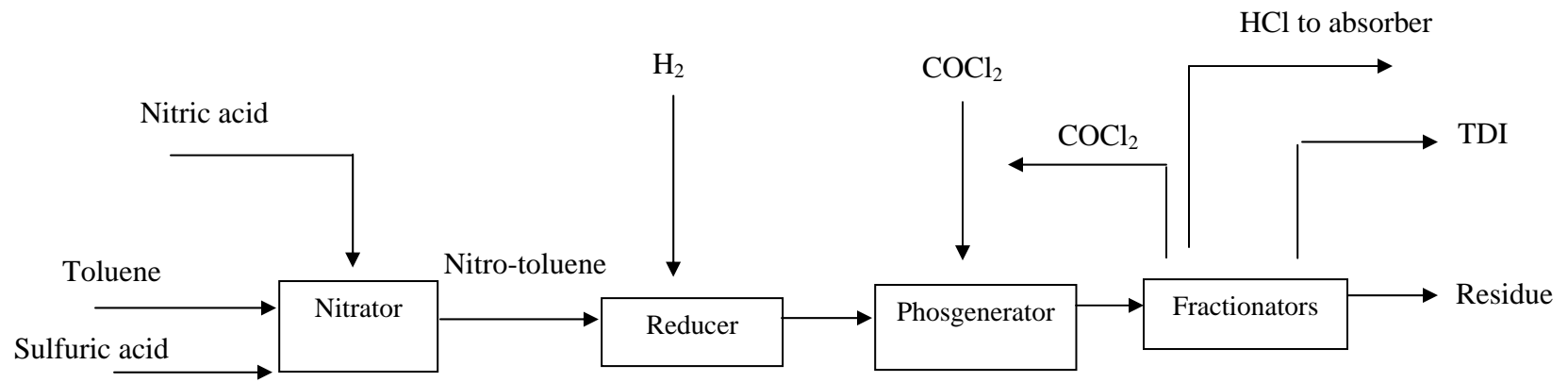

Fig. 3.17: Block diagram for TDI

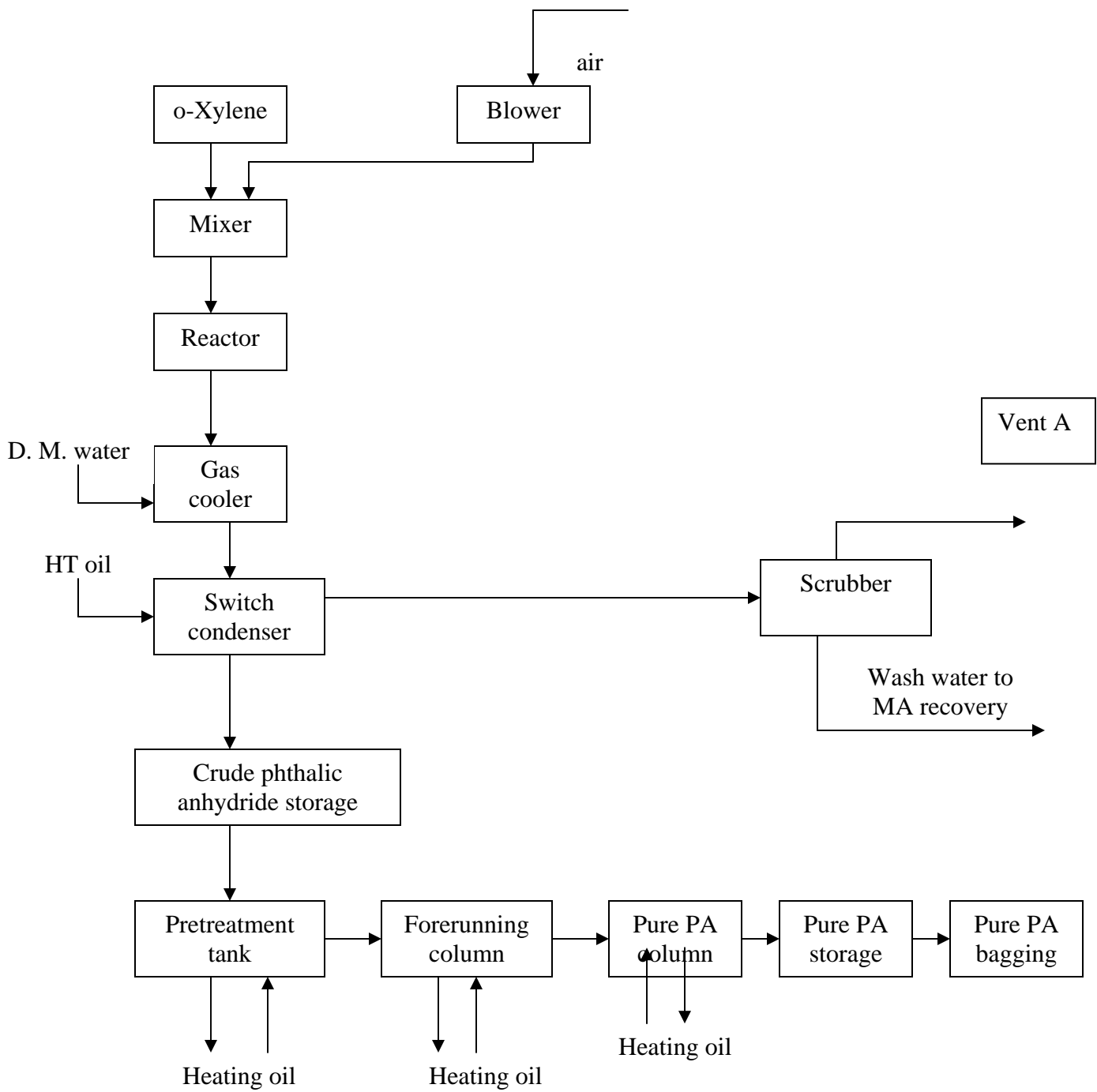

Fig. 3.18: Block diagram for Phthalic anhydride

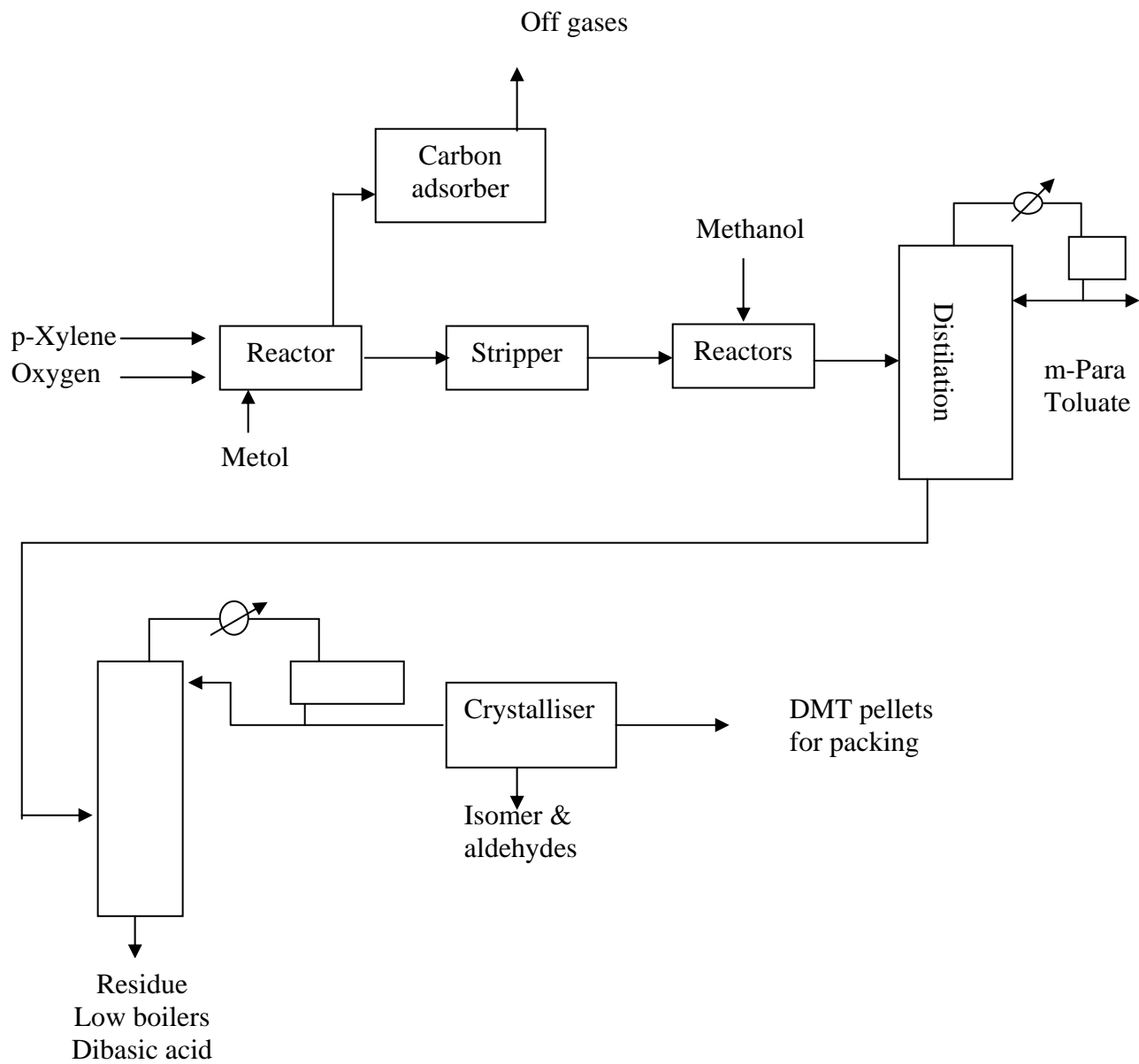

Fig . 3.19: Manufacturing Process & Block Diagram of DMT

CHAPTER-4 EMISSION SOURCES IN PETROCHEMICAL PLANTS

4.0 COMMON EMISSION SOURCES

Petrochemical production processes are rather specific to the feedstock and product and so are the process emission sources and the air pollutants. However the petrochemical processes utilise many common activities and thus it is possible to consider in a generic manner where the air emission streams may arise and what those streams may contain. Broadly petrochemical production unit producing a specific intermediates or final product generally involves distinct processing modules viz.:

- Feed raw material supply and pre-treatment
- Synthetics
- Production separation, refinement and co-product recovery

Besides the specific unit may involve intermediates product storage and handling and also dedicated disposal system for gaseous streams like incinerators etc. The emission sources from the petrochemical complex are classified also as "point sources" and "non-point sources" as given below:

Point sources

- Combustion sources (power and steam generation)
- Process / intermittent vents
- Emission due to transfer process
- Storage emission
- Emission control and disposal modules (Viz. flare, incinerator etc.)

Non Point sources (Fugitive emission)

- Equipment leak
- Cooling water, wastewater collection and treatment system

4.1 Emission from Combustion sources (power and steam generation)

Combustion gases may originate from primary sources such as process furnaces, steam boilers, turbines and engines, but also from pollutant abatement facilities (e.g. incinerators and flares). Whilst process furnaces are usually dedicated to one process, steam and electricity producing units often serve a complete petrochemical complex and their emissions cannot be allocated easily to one process.

Combustion units will generate emissions to air that are related to combustion conditions (e.g. CO₂, H₂O, NO_x, C_xH_y, CO, soot) and fuel composition (e.g. SO₂, fuel-NO_x, metals, soot).

Generally, gaseous fuels is predominantly used in the petrochemical industry, these are the low-boiling gaseous fractions from the processes (e.g. hydrogen, C1-C4 hydrocarbons). In general, gaseous fuels combust cleanly and result in the lowest emissions. Gaseous fuels are normally low in sulphur and have a low content of bound nitrogen, and so the SO_x and fuel NO_x emissions from gas firing are relatively low. Emissions may be increased by air pre-heating (higher thermal-NO_x emissions) and sulphur or nitrogen compounds in the fuel (may cause fuel-NO_x and fuel-SO₂ emissions). The high temperatures in so-called 'high temperature process furnaces' may also increase thermal-NO_x emissions.

Light liquid fuels viz. Naphtha are occasionally used in the petrochemical industry. Further liquid fuels can also be residual higher boiling fractions from the process and industrial gas oil or fuel oil. Emissions depend mainly on the concentration of impurities in the fuel. In particular, 'heavy' liquid fuels may cause emissions of dust and heavy metals (due to ash content), emissions of NO_x and SO₂ (due to nitrogen and sulphur content) and have an increased potential for soot formation.

Nitrogen (NO_x) is generally the critical pollutant from Petrochemical Complex generated at the combustion devices located within the process plant (viz. fired heater, incinerator) or at the utility facilities (viz. Steam and Power generation). Further, because of its (NO_x) atmospheric photochemical reaction potential with volatile organic compounds (i.e. photochemical Ozone formation potential *i.e.* POCP), as shown Fig. 4.1, it demands for restriction / abatement of NO_x formation at the combustion devices by adopting suitable measures.

4.2 Emission Profile from Olefin Complex

4.2.1 Plant boundary definition and the degree of integration

A number of operations are directly associated with olefins production, including feed pre-treatment, butadiene recovery or hydrogenation, gasoline heat soaking or hydro treatment benzene concentration or extraction and tar (residue from heavy gas oil fields) handling. Fully integrated olefins plants naphtha or gas oil feed stock may include some or all of these associated processes within cracker ISBL (Inside battery limits), but these operations may be undertaken in separate facilities that also process streams from other plants.

Olefin plants require the principal utilities (steam, power and cooling water) as well as provision for wastewater treatments. In addition, they require the

capability to flare waste gases during an upset condition and certain intermittent operations. In only a limited number of cases, the olefin plants are totally independent unit with dedicated services. More typically, the olefin plant is part of an integrated petrochemical complex, where common utilities are provided by central facilities.

Olefin plants are frequently used to recover vent and purge streams from other units (e.g. polymer plants), on an integrated site, and thus eliminates the requirement for off gas disposal. Residues from the cracking of heavy feedstock such as gas oil can also be recovered as fuel oil for subsequent stream and power generation.

Total olefin plants emission will therefore depend on how the plant boundaries are defined and what associated processes are within its battery limits. Generally, the following are olefin plant boundaries:

	Normally include	May include
ISBL	<ul style="list-style-type: none"> • Cracking furnaces • Primary fractionation/ water quench • Cracked gas compression/ acid gas removal/ drying • Cold fraction • Refrigeration Systems • Hot fractionation (only limited requirement for gas crackers) • Hydrogenation units as required • Intermediate storage 	<ul style="list-style-type: none"> • Feed pre-treatment (for contaminant removal) • Associated processes (e.g. propylene purification, butadiene extraction), gasoline heat soaking, hydro-treatment, tar/ residue handling) • DM Water and Boiler Feed Water Treatment • Auxiliary boilers/power generation facilities • Cooling water systems • Effluent treatment systems (whole or partial) • Flare
OSBL	<ul style="list-style-type: none"> • Power generation and supply • Steam generation and supply • Ancillary services (e.g. air, nitrogen) • Effluent treatment (partial or whole) • Main storage 	<ul style="list-style-type: none"> • Auxiliary boilers • Cooling water supply/ return • Flare

4.2.2 Emission related to feed stock

Emission levels are normally reported on a per ton ethylene basis. However, this can introduce problems when comparing plant performances since the actual emissions relates not only ethylene production, but also to the production of other olefins based on feed stock used

On a per ton ethylene basis, emissions will tend to be lower for those plants using gas feed stocks than those using naphtha or gas oil. As general rule, the percentage conversion of hydrocarbon to lower olefins reduced as the molecular weight of feed stock increases. For illustration, approximately 80% of ethane is converted ethylene in the gas cracking process where as ethylene yield from naphtha is typically 30-35%. However, virtually no propylene (the next most important olefin) is produced from ethane gas cracking, whereas propylene production from naphtha can be as high as 70 % ethylene production.

Even when cracking identical feedstock, there is some flexibility to change the proportion of high value products by adjustment of cracking severity, according to the specific needs of the producer. Cracking severity and feed stock type can also affect operations such as furnace run length (length of time between stream /air de-cokes) or acetylene converter run length (time between regenerations) which can have as secondary effect on specific emissions.

Thus, caution must be used when comparing emission levels on a per ton ethylene basis, industry performance bench marking often considers other ratios such as (i) per ton of ethylene product (ii) per ton olefins (ethylene plus propylene); and (iii) per ton high value chemicals (ethylene, propylene, recovered hydrogen, butadiene and benzene).

4.2.3 Scale of operations

Unit capacity (measured in tones of ethylene production) can have an impact on specific emissions, particularly to air. The technique used to estimate non –point (fugitive) emissions makes no allowance for through put or the size of source. Since most olefin units have a similar number of units operation and point sources, plants with low capacity and lower ethylene yielding feed stock will tend to show disproportionately high specific emission to atmosphere. The scale of Indian ethylene plants has increased from an average initial installed capacity of 0.150 MMTPA to 0.3 to 0.7 MMTPA during 90 's. Current world scale is considered to be around 0.6-0.8 MMTPA.

4.2.4 Plant age

Older plants will tend to suffer a technology disadvantage in that furnace conversion, selectively, rotating equipment specification and over all energy efficiency are lower than in modern plant. Older plants may have more direct emission routes for non-routine or emergency situations i.e. atmospheric (as opposed to closed system) safety valve discharges. Older units may also have less well developed energy recovery systems, compression train efficiency, control systems and high –integrity equipment to avoid fugitive emissions. Older plants can therefore have higher specific emissions than modern units.

4.2.5 Air emission /emission factors and inventory

The principle pollutants and their sources and the emission factor (kg pollutant / ton of ethylene product) for olefin (cracker) unit is given below.

Source	Pollutant				
	NO _x	SO ₂	CO	VOC	Particulate
Gas-fired furnaces/heaters	X	X	X	X	
Gas-fired turbines	X	X	X	X	
Liquid Fuel Fired Boilers	X	X	X	X	X
Point Sources	X	X	X	X	X
Maintenance activities				X	
Fugitive Emissions				X	
Decoking Operations	X		X	X	X
Sour Gas Disposal		X			
Regeneration Furnaces	X	X	X	X	
Emission Factor (kg/t ethylene)	1.0-2.8	0.01-3.3	0.2-1.0	0.03-6.0	0.05-1.5

4.3 Emission from cracker furnace (steady state operation)

The furnace area is defined as that part of the process comprising the pyrolysis heaters, complete with heat exchange equipment for generating high-pressure steam, and any separately fired steam super heaters. It excludes auxiliary boilers and regeneration furnaces.

In volume and pollutant terms, the most significant emissions to air result from the combustion of fuels in the pyrolysis cracking furnaces. The operating conditions of the cracking furnaces are frequently changed in order to provide the desired product distribution and this may affect optimal control of the combustion process.

The cracker furnaces generally use the recovered off-gas as energy source i.e. fuel. This off-gas is very lean and clean fuel (rich in C1 and H2) and generally having no sulphur. The Nitrogen Oxide (NO_x) and Carbon Monoxide (CO) are the major pollutant in the cracker flue gas.

Data on emissions of carbon monoxide (CO) and nitrogen oxides (NO_x) are presented herein based on extensive study.

	CO (mg/Nm ³)		NO _x (mg/Nm ³)	
	Number	Range	Number	Range
Full range	35	0.2 – 620	39	61 – 250

Sulphur Dioxide Emissions: International survey reported levels of SO₂ emissions in the range 20 – 100 mg/Nm³ (as 30-60 minute averages at normal temperature and pressure, 3% oxygen, dry gas). The SO₂ emissions are not normally considered to be significant for steam crackers. However, the SO₂ emission will be governed specially by the fuel used in the furnace.

Particulate Emissions: A general survey of the Petrochemical Units world wide reflects particulate emissions in the range 0.2-25 mg/Nm³. Which is again governed by the type of fuel used and the furnace design and the burner design / efficiency. Besides, polymer production and polymer dust handling can contribute but not very significantly. Nevertheless, the normal particulate emission is not of critical consequence for an Olefin Cracker Unit.

The emissions of SO₂ / NO_x / SPM Hydrocarbons were monitored at cracker complex and findings are presented in Table 4.1

The NO_x generation depends on the flame temperature (which is a function of burner technology, fuel gas composition and furnace geometry) and quantity of excess air.

Table 4.1: Cracker – Flue Gas Analysis (Unit – I)

Stack No.	I	II	III	IV	V	VI	VII
Connected to	SRT Heater 101	SRT Heater 102	SRT Heater 103	Super Heater 107	Super Heater 108	Boiler GT 1709	Boiler GT 1710
Stack height (m)	57	57	57	40	40	50	50
Stack diameter (m)	2.5	2.5	2.5	1.5	1.5	2.75	2.75
Fuel used	GAIL Gas / Process off-gas					GAIL+ Light ends	

Stack No.	I	II	III	IV	V	VI	VII
Connected to	SRT Heater 101	SRT Heater 102	SRT Heater 103	Super Heater 107	Super Heater 108	Boiler GT 1709	Boiler GT 1710
Fuel quantity (Nm ³ /hr)	2981	2885	3201	744	520	-	-
Temperature (°C)	287	277	294	187	179	185	190
Velocity (m/s)	5.6	5.5	5.7	1.8	1.8	9.7	9.7
Flow rate (m ³ /hr)	98,960	97,193	1,00,727	11,451	11,451	2,07,410	2,07,410
Parameters monitored							
TPM	-	-	-	-	-	-	-
SO ₂ (mg/Nm ³)	11.81	9.35	19.7	7.15	NA	30.03	NA
NO _x (mg/Nm ³) (*)	190.9	124.5	225.2	110.9	NA	183.7	NA
Hydrocarbon as CH ₄ (ppm)	BDL	BDL	BDL	BDL	BDL	BDL	BDL

NA = Not analysed

BDL = Below detection limit

4.3.1 Emission from cracker furnace (de-coke operations)

All cracking furnaces require periodic de-coking to remove carbon build-up on the radiant coils. The carbon layer acts as an insulator, and requires the use of higher tube metal temperatures to maintain the desired feed stock conversion. At a pre-determined level, dictated by the coil metallurgy, the furnace must be de-coked to restore its performance and the carbon is burned to carbon dioxide. Cycle times vary significantly for different feed stocks, coil configurations and the operating severity, but are typically in the range 14-100 days. It should be noted, however, that the extent of coke build-up is time dependent, so those furnaces requiring frequent de-cokes will generally have a much lower coke build-up than those with extended cycles.

The particulate matter (SPM) and Carbon Monoxide (CO) are the critical pollutants emitted during decoking operation. Particulate emissions are generally observed in the range 80 – 600 mg/Nm³, although the highest figures relate to peak values observed during dry de-dusting. De-coking emissions are not monitored by dedicated equipment (e.g. on-line analysers) since furnace de-

coking is an infrequent operational mode (typically only 3% of the time). During the de-coking phase, process control is important to minimize particulate emissions and there is typically visual inspection of the emission point and close supervision of the process parameters (e.g. temperatures).

CO emissions are reported in the range 1-2700 mg/Nm³ (as 30 – 60 minute averages at normal temperature and pressure, 3% oxygen, dry gas). The highest figures were again encountered at the start of the operation.

4.3.2 VOC from cracking process

During normal operation there are very few VOC emissions from the cracking process because they are recycled into the process, used as a fuel or routed to associated processes on an integrated site. Higher VOC emission from ethylene plants are rather intermittent, but occur during plant start-up and shutdown, process upsets and emergencies. Volatile organic compounds may be emitted from pressure relief devices, intentional venting of off-specification materials or depressurising and purging of equipment for maintenance. Crack gas compressor and refrigeration compressor outages are potential sources of short-term, high rate VOC emissions. The chief source of benzene emissions during normal operation is the crack gas compressor lubricating oil vent. In general, intermittent emissions, all pressure relief devices, and emergency vents are routed to flare through the main process vent, which is usually controlled. The relief valve from the de-methaniser usually vents to atmosphere, but the valve is operated very infrequently and emits mainly hydrogen and methane. Volatile organic compounds from such sources as cracking furnace flue gas, pyrolysis furnace decoking, acid gas removal and hydrogenation catalyst regeneration are not generally significant.

In typical olefin plant, hydrocarbons are mostly emitted due to leakage and flaring of the residual gases. Generally, VOC emissions were attributed to 72% from leakage losses from appendages, pumps, etc. 18% from flaring and disruption, 1% from losses due to storage and handling, 5% from combustion and 4% from other process emissions.

4.3.3 Emission inventory from olefin complex

The emission inventory presents the typical emission factor and the annual emission load expected from an olefin complex having a capacity of 500,000 TPA Ethylene is given below in Table 4.2.

**Table 4.2: Olefin Complex (0.5 MMTPA Ethylene)
Typical Emission Inventory**

S. No.	Parameter	Conc. at the source (mg/Nm ³)	Emission Factor Kg/T Ethylene	Typical Emission Inventory (Annual Load in TPA)
1.	CO	25-50	0.5 – 1.0	250 – 500
2.	SO _x	40 – 100	0.04 – 0.1	20 - 50
3.	NO _x	200 – 250	2.0 – 2.5	1000 – 1250
4.	Flare Load (Normal) (Max)	-	10 – 15 35 – 45	5000 – 7500 17500 – 22500
5.	Total VOC Load (uncontrolled)	-	3.5 – 5.0	1750 – 2500
6.	Fugitive VOC		3.2 – 3.5	1600 – 1750

4.4 Emission from aromatic plants

Emissions from aromatic plants are contributed to a large extent due to the utilities needed by the aromatic separation processes. A relatively minor component of the emissions are related to core processes, but there may be emissions due to the elimination of certain impurities, inherent waste streams generated during processing and emissions from equipment. Some chemical reaction takes place at high pressures and temperatures, but these are inherent to processes.

In order to understand the emission profiles for aromatic plants the definition of plant boundaries and the degree of integration with upstream and down stream process is necessary. Plants are usually described in terms of equipment and processes units inside battery limits (ISBL) and outside battery limits (OSBL). The principal pollutants and emission sources from various aromatic plants are given in Table 4.3.

Table 4.3: Emission sources and pollutants from various aromatic plants

Source	Pollutants				
	NOx	SO ₂	CO / CO ₂	VOC	Particulates
Gas Fired Heater	X	X	X	X	
Point Source	X	X	X	X	X
Maintenance activities				X	
Non Point emission (Fugitive)				X	
Regeneration furnaces	X	X	X	X	

Typical combustion emissions are quantified in Table 4.4 for three typical process configurations depicting the typical Emission Factor (Kg Pollutant/Tone of Feed Stock)

Table 4.4: Combustion emissions to air from aromatics processes (in Kg/t feedstock)

	Process configuration		
	Benzene from pygas	Benzene from hot alkali digester of TX cuts	Reformate plant
NOx	0 – 0.056	< 0.1	< 0.06 – 0.123
SO ₂	0 – 0.5	Usually negligible	0.146
Particulates	0.0025		0.008

4.4.1 Volatile organic compounds (VOCs) from aromatic plants

There are generally no continuous VOC emission point sources in aromatics plants, although some plants may use vacuum systems that have a continuous air emission. Most VOC emissions are normally from non-point i.e. fugitives (e.g. valve, flange and pump seal leaks) and from non-routine operations (maintenance, inspection). However, due to lower operating temperatures and pressures, the fugitive emissions from some aromatics processes are considerably less than in other Petrochemical processes where higher temperatures and pressures are employed.

The quantification of fugitives is dependent on the calculation method, but experts consider that a release of 50 t/year of hydrocarbons (including benzene) is a plausible order of magnitude for non-routine emissions from a typical aromatics installation with proper leak detection and repair programme in place and also use of high integrity (i.e., inherently low leak) equipment. VOCs may arise from small leaks in the cooling unit as ethylene, propylene and/or propane can be used as coolant fluids in the p-xylene crystallization unit.

VOCs may also result from storage tank breathing losses and displacement of tanks for raw materials, intermediate products and final products. The VOCs can be aromatics (benzene, toluene), saturated aliphatics (C1-C4) or other aliphatics (C2-C10).

The typical emission factor for aromatics plant is given below.

Plant	Emission source	Emission type	Pollutant	Emission Factor (kg/T of BTX product)
Process A (BTX from aromatic mixture-reformate)	Flare	Point	SO ₂	0.53
			NO _x	0.86
	Tank	Point	VOC	0.05
Process B (benzene from pygas i.e. Naphtha Cracker)	Various	Fugitive	VOC	0.15
			Methane	0.09
Process B (benzene from pygas i.e. Naphtha Cracker)	Desulphurising	Point	SO ₂	0
	Furnaces	Combustion	NO _x	0.013
			CO	0
			VOC	0.0008
	Process	Point	VOC	0
		Fugitive	Benzene	0.010
			Toluene	0.004
			Pentane	0.004
VOC saturated C1-C4			0.0005	
VOC aliphatics C2-C10	0.0018			
Total aromatics	0.017			
Total VOC	0.030			

4.5. Emission from Butadiene Plant

4.5.1 Process vent

This process vent emission comprises:

- Hydrocarbons from extractive distillation to fuel gas system
- Hydrocarbons from Butadiene purification (propynes) & solvent recovery vent (C₄ acetylene)

The C₄ vapours (raffinate) from extractive distillation steps contain primarily butanes and some quantity of butenes are either sold as product or taken to catalytic hydrogenation unit for blending in LPG.

The C₄ vapours vented during solvent recovery (C₄ acetylene) and butadiene purification (propynes) are either flared or taken to fuel gas system.

4.5.2 Fugitive emissions

The fugitive emissions sources of butadiene plants include pumps, valves, flanges, sampling systems etc. and emissions during plant decommissioning for maintenance. The fugitive emission profile of two butadiene plants of India is given Table 4.5.

Table 4.5: Fugitive emissions of Butadiene plant

S. No.	Plant	Equipment	Fugitive Emission kg/yr
1	<u>Unit -I</u>	Pumps	1081.48
2	(Capacity 36000 TPA)	Valves	7008.41
3		Flanges	13246.08
4		Screwed fitting	367.97
5		PRV's	380.42
6		Open ended lines	138.58
	Total		22222.94
A	<u>Unit-II</u>	Pumps	1351.85
B	(capacity 11000 TPA)	Valves	9034.27
C		Flanges	9000.45
D		Screwed fitting	459.96
E		PRV's	475.52
F		Open Ended Lines	173.26
	Total		20495.31

Work Place Monitoring

Work place monitoring results recorded at two units are reported in **Table 4.6**

Table 4.6: Work Place Monitoring Data

Component	Range of Values (Threshold limit value –time weighted average)	OSHA Standard
Unit-I	0 – 7.0 ppm	1 ppm
Unit-II	0 – 10.0 ppm	1 ppm

4.6 Emission from xylene plants

The gaseous emissions occur from xylene plants are given below.

- a) Heating furnace stacks
 - b) Process vents
 - c) Fugitive emissions
 - d) Storage emissions
- a) Heating furnace stacks: Heating furnaces (in hydro-treating / reformers /transalkylation etc) normally use process off gas separated during separation / stabilisation processes and other lighters separated during distillation. In case of shortage of off gas and lighters other conventional fuels such as furnace oil/ LSHS etc are used. The parameters of significance are as follows:

<u>Gas fired furnace</u>	<u>Oil/Dual fired furnace</u>
NO _x	SO ₂
SO ₂ (*)	NO _x
	TPM

(*) Sometimes H₂S generated in hydro-treating section is recycled to heating furnaces and hence some SO₂ gets liberated in the furnaces.

- b) Process Vents: The vents opening directly into the atmosphere are Continuous Catalyst Regeneration.
- c) Fugitive Emissions: Xylene have high boiling point and thus lower volatility as also health hazards are not severe. However, streams containing benzene have generally being seen to have equipment components having maximum precaution to prevent leaks e.g. Pumps are

provided with double mechanical seals / distillations vents are sent to flare etc.

Flue gases were monitored in process heaters and continuous catalyst generation unit. The data is presented in **Table 4.7**

Table 4.7: Monitoring of flue gases in Xylene plants (Unit – V)

Parameter		Process Heater			CCR (*)
		D-2001 (+)	D-7001 (+)	1041	
1	Date of sampling	08.11.2003	08.11.2003	08.11.2003	08.11.2003
2	Temperature (°C)	305	246	296	
3	Fuel	Process off gas			
4	Flue gas quantity (Nm ³ /hr)	2583	21091	13988	--
5	SO ₂ (mg/Nm ³)	42.66	17.38	14.22	--
6	NO _x (mg/Nm ³)	124.1	97.86	175.2	--
7	Carbon Monoxide (mg/Nm ³)	--	--	--	19.5
8)	TPM (mg/Nm ³)	--	--	--	37.4

(+) with low NO_x burners

(*) CCR – Continuous catalyst Regeneration

4.7 Emission from ethylene oxide and ethylene glycol plant

The Process emissions from the EO/EG plant include:

- Re-absorber vent
- CO₂ Purge
- Inerts Vent
- Residual EO Absorber

Re-absorber Vent

A recycle gas compressor is generally provided to recycle re-absorber vent to oxidation reactor. In one unit, the vent has to be sent to atmosphere. All other plants in India have recycle gas compressor.

CO₂ Purge

The CO₂ purge is removed from the recycle gas in oxidation section to prevent CO₂ build-up. The CO₂ is absorbed in K₂CO₃ solution and off-gas sent back to oxidation reactor. The K₂CO₃ solution is stripped off and K₂CO₃ recycled back to absorber. The stripper vent is released to atmosphere.

New plants have an inbuilt flasher, which removes organics from the K₂CO₃ solution and recycles them to oxidation reactor before stripping off CO₂. This ensure that maximum amount of organics are re-used and reduces organics concentration in vent.

Inerts Vent

The inerts vent in nearly all plants is taken to fuel gas system/flare tip (by separate line) and hence was not monitored.

Residual EO Absorber

This is provided to scrub EO from vent gases originating from various sources such as releases of Pressure Relief Valves / emissions during Tanker loading / equipment depressurising for maintenance / pure EO distillation column etc.

The emission data for these vents were monitored at three units and data was collected from other two units. The emission data in respect of process vent sources is presented in **Table 4.8**. As observed, the installation of flasher has reduced volatile organic compounds in the vent at a new unit, drastically, as compared to that at old unit.

Table 4.8: Process Vent Analysis (EO/EG)

	CO ₂ Purge Stream		EO Re-absorber		Residual EO Absorber	
	Unit -II	Unit -III	Unit-I		Unit -IV	Unit -II
			Normal Operation	Abnormal Operation		
Stack temperature (°C)	108	--	45	51	Ambient	Ambient
Flow rate (m ³ /hr)	3478	8196	4891	5054	--	--
Pollutant Parameters						
Carbon di oxide (% wt)	37.35	66.81	60.11	59.86	--	--
Ethylene (g/m ³) (% wt)	15 (1.2)	0.25 (0.02)	162 (13)	187 (15)	--	--

Ethylene oxide (mg/m ³) (% wt)	373.2 (0.019)	Traces	392.8 (200)	982.14 (500)	13.72	19.6
Ethylene Glycol (mg/m ³) (% wt)	3875 (0.14)	2214 (0.08)	--	--	--	--

Fugitive emissions occur primarily from pump seals, compressors, valves, flanges, pressure relief valves and sample connections particularly because large quantities of volatile organic compounds are handled at high pressure. Fugitive emissions can be estimated by applying average USEPA / TNO emission factors to the number of pumps, valves, flanges etc. Detailed data on number of components, their rating, service, seal type etc was made available by Unit –I and results have been presented in **Table 4.9** .It is assumed that emissions are uncontrolled; employ no leak detection and repair and maintenance measures. Inspection and Maintenance (I/M) programs in which equipment is routinely monitored and leaks corrected will substantially reduce these emissions.

Table 4.9: Fugitive Emissions Calculations (Unit- II)

S. No	Service	Emissions (Kg / hr) Capacity: 24000 TPA						
		Flanges	Valves	Pumps	Screwed fittings	PRV's	Open ended lines	Comp-ressors
1	Ethylene Oxide	0.4225	1.041	0.5434	0.0276	0.936	0.0229	-
2	Ethylene Glycol	0.4108	0.1907	0.3952	0.0246	0.832	0.0089	--
3	Ethylene	0.08217	0.812	--	--	--	--	--
4	Ethylene + EO	0.01826	--	--	--	--	--	--
5	Propylene	0.0996	--	--	--	--	--	0.456
6	Isopar	0.117	0.4704	--	--	--	--	--
7	Methane	--	0.112	--	--	--	--	--
8	DEG	--	--	0.1482	0.00092	0.312	0.077	--
9	TEG	--	--	0.1976	0.0123	0.416	0.0102	--
	TOTAL	1.1503	2.6261	1.2844	0.0737	2.496	0.119	0.456

**Total emissions = 8.2085 Kg/hr
= 197.0 Kg/ Day (say 0.2 TPD)**

Work room environmental monitoring

Monitoring of workroom atmosphere has shown following ranges of Ethylene Oxide concentration.

Work Room Monitoring Results – Ethylene Oxide	
Plant	Monitored Range (ppm)
UNIT-I	0 - 3
UNIT-II	0 - 2

4.8 Emissions from EDC and VCM plants

These include i) vent from direct chlorination section and ii) vent from oxy-chlorination. These two vents along with other releases (like SRV's) are scrubbed with caustic before discharging to atmosphere.

The vent from direct chlorination and oxy-chlorination are taken to low temperature chlorinator, where they are reacted again with chlorine to utilize maximum amount of ethylene. The vent from low temperature chlorinator are passed via refrigerated condenser, scrubbed and then discharged to atmosphere. This results in much reduced concentration of organics as can be seen in **Table 4.10**.

Process emissions of EDC also result from the release of gases from the column vents. Column vents include vents from the wastewater steam stripper, the drying column, the heads column and the EDC / VCM finishing column.

Table 4.10: Process Vent Analysis Results – EDC / VCM

Stack Connected to	Caustic scrubber	
	Unit-I	Unit-III *
a) Stack height (m)	21.5	50
b) Stack Diameter (m)	1.36	1.7
c) Temperature (°C)	40	40
d) Velocity (m/s)	-	-
e) Flow rate (m ³ /hr)	4,183.69	1634.3
Pollutant Concentration		
a) Oxygen (%)	1.85	1.5
b) Chlorine (kg/hr)	Nil	Nil
c) Ethylene g/m ³ (%)	150 (12.04)	309 (24.72)
d) Ethyl Chloride mg/m ³ (%)	4422 (0.165)	14285 (0.05)
e) Vinyl Chloride Monomer mg/m ³ (%)	650 (0.025)	48714 (1.76)
f) Ethylene dichloride mg/m ³ (%)	20961 (0.51)	15026 (0.34)

Note: * Data obtained from manufacturer.

In addition to the above, modern EDC / VCM plants have a dry vent header (DVH) and wet vent header (WVH) to capture any releases of chlorinated hydrocarbons due to leaking equipment / during maintenance / process operation such as equipment depressurising and SRV / PRV releaser. The DVH is provided to collect hydrocarbon emissions from process areas where moisture content is low (<20 ppm) this is normally the area up to EDC cracker. The WVH is provided to collect hydrocarbon emissions where appreciable moisture may be present this is the area near oxy-chlorination and near EDC waste water stripper. These vents (DVH & WVH) are generally treated together in the incinerator.

Stack connected to fuel burning sources

These include:

- Stack connected to EDC cracker furnace
- Stack connected to Incinerator

The fuel for the above equipment is the fuel gas generated in cracker/or the natural gas feedstock. The emissions from EDC cracker will mostly comprise Nitrogen Oxides, while Incinerator emissions will contain Nitrogen Oxide and other traces of chlorinated hydrocarbons. Possibility of dioxin generation in the Incineration cannot be ruled out considering high temperature and presence of chlorinated hydrocarbons.

The analysis results of two incinerators system have been given in **Table 4.11**.

Table 4.11: Analysis of Incineration off-Gases

Parameter	Analysis Results	
	Unit -IV	Unit-III (+)
Temperature (°C)	20	Ambient
Fuel	Off-gas	Off-gas
Flow-rate (Nm ³ /hr)	11,000	2,500
Vinyl Chloride (ppmv)	Nil (+)	10
Chlorine (mg/Nm ³)	3.2	9
Nitrogen oxides (ppm)	125	150
Hydrogen chloride (mg/Nm ³)	30.4	20
Ethylene dichloride (ppm)	0.333	--
Sulphur di oxide (mg/Nm ³)	17.2	40
(+) Data provided by company.		

Fugitive Emission

Fugitive emissions of EDC/VCM and other volatile organics result from leaks through valves, pumps, compressors, and pressure relief valves. Fugitive emission quantities for specific production facilities are dependent on age of equipment, level of preventive maintenance, and leak detection programs. New plants has lot of preventive measures to minimize fugitive emissions due to high toxicity of EDC / VCM.

The measures taken in various plants in India are summarised in **Table 4.12**.

Table 4.12: Fugitive Emission Control Practices – Existing Units

S. No	Component	Plants		
		Unit-I	Unit-III	Unit-IV
1	Pumps (EDC)	<ul style="list-style-type: none"> ▪ Single mechanical seal 	<ul style="list-style-type: none"> ▪ Double mechanical / Tandem seal. ▪ Degassing vent to incinerator. (*) 	<ul style="list-style-type: none"> ▪ Double mechanical / Tandem seal. ▪ Degassing vent to incinerator. (*)
2	Valves (Chlorine)	<ul style="list-style-type: none"> ▪ Bellow seal (control valve) (*) ▪ Extended bonnet (isolation valves) (*) 	<ul style="list-style-type: none"> ▪ Bellow seal (control valve) (*) ▪ Extended bonnet (isolation valves) (*) 	--
3	Valves (VCM)	--	<ul style="list-style-type: none"> ▪ Extended bonnet (control valves) (*) ▪ TOFLEEN valves with Teflon packing (Isolation valves) (*) ▪ Plug / Ball valve (with welded connections only) (*) 	<ul style="list-style-type: none"> ▪ Plug valve (with CAF packing)
4	Valves (EDC)	--	--	<ul style="list-style-type: none"> ▪ with Teflon / metal packing
5	Instrument connection	Threaded connection seen	<ul style="list-style-type: none"> ▪ No threaded connection (*) 	--
6	Sample	Open loop	<ul style="list-style-type: none"> ▪ Closed loop (*) 	<ul style="list-style-type: none"> ▪ Closed loop (*)

S. No	Component	Plants		
		Unit-I	Unit-III	Unit-IV
	Collection			
7	Compressors	--	▪ Labyrinth seal (*)	--
8	Propylene Compressor	--	▪ Dry gas seal (*)	--
9	Recycle gas compressor	--	▪ Dry gas seal (*)	--
10	HTC Compressor	--	▪ Double gland packing (1 st zone back to process / 2 nd zone to atm.)	--
11	Flanges (EDC)	--	--	▪ Metal Gaskets (*)
12	Flanges (VCM)	--	--	▪ Spiral bound CAF
13	PRV's	To atmosphere	▪ With upstream rupture disc ▪ Vent to incinerator (*)	▪ With upstream rupture disc ▪ Vent to incinerator (*)
14	On-line monitoring	--	▪ 20 locations	▪ 29 locations + Portable instrument
Components marked (*) represent best Practise in industry.				

The component emissions were computed from the USEPA average emission factors and component inventory and results are presented in **Table 4.13**.

Table 4.13: Estimation of Fugitive Emissions from a Typical plant (Unit- I)

S. No.	Equipment	Nos.	Fugitive emissions
1	Rotary compressor	2	3.097
2	Centrifugal pump	68	9.195
3	Valves	2176	59.57
4	Flanges	9180	114.12
5	Screwed fitting	252	3.087
6	PRV's	68	3.233
7	Open ended lines	102	1.177
		Total	193.48

As can be seen, the total fugitive emissions are estimated at 193.48 Tpa from the said unit.

4.9 Emission from acrylonitrile

Air emission may occur from several sources such as process vents, storages, transport and loading facilities, and incinerator/flare. Fugitive emissions may also occur from leaks in pumps compressors and valves. These emission sources are described below:

Process Vents:

Process emissions from the Sohio process occur from the absorber vent the distillation column purge vents and the Hot Alkali Digester (provided to reduce Cyanide in effluents to 1 ppm level). The emissions from absorber vent and Hot Alkali Digester vent during normal operation (@ capacity of 85 TPD) were monitored at one acrylonitrile plant at on two consecutive days and the results are presented in Table 4.14.

Table 4.14: Acrylonitrile Plant Process Vents Plant operating load : 85 TPD (Unit-I)

S. No.	Parameters	Stack Connected to HCN Absorber		(Hot Alkali Digester) Vent
		Day 1	Day 2	Day 1
1	Stack height (m)	65	65	67
2	Stack diameter (m)	1.6	1.6	3.0
3	Fuel used	--	--	--
4	Fuel quantity (Kg/hr)	--	--	--
5	Temperature (°C)	40-50	40-50	--
6	Velocity (m/s)	2.7	2.7	--
7	Flow rate (m ³ /hr)	19,380	19,380	--
Parameter concentration				
a)	NOx ppm	345.0	--	--
b)	NH ₃ mg/Nm ³	--	--	7.20
c)	HCN TPD (mg/m ³)	0.0079 (17.1)	0.0078 (16.78)	--
d)	SO ₂ , (mg/m ³)	--	--	--
e)	Acetonitrile TPD (mg/m ³)	0.26 (558.56)	0.0995 (213.92)	--
f)	Acrylonitrile TPD (mg/m ³)	0.13 (276.64)	0.75 (161.92)	--

Literature study indicates that VOC emission during start-up is substantially higher than during normal operation. During start-up the reactor is heated to operating temperature before the reactants (propylene and ammonia) are introduced. Thus, the reactor product stream is initially oxygen-rich. As the start-up progresses and the reactants are introduced, the acrylonitrile and VOC content of the reactor effluent increases until the acrylonitrile-rich composition indicative of normal operation is reached. During part of this start-up process, the composition of the reactor product stream is within its explosive limits and must, therefore, be vented to the atmosphere to prevent explosions in the lines to the absorber. Emission of acrylonitrile from a single reactor during startup has been reported to be as high as 4500 kg/hr (10,000 lbs/hr). However, emissions associated with start-up occur rather infrequently, with each reactor having about four start-ups of 1-hour duration per year. Even so, acrylonitrile emissions during start-up totalled over an entire year are higher than emissions from the absorber vent during normal operation. In one unit, the HCN vapour stream is connected to both flare and incinerator, so that during start-up there is 100% standby to destroy the cyanides before discharging to atmosphere. Literature also indicates high acrylonitrile content in the combined column purge vent gases (about 50 weight percent of the total VOC emitted from the columns). The vent gases from the recovery, acetonitrile, light-ends, and product columns are flared.

Combustion Emissions

A multi-purpose Incinerator is provided in the plant to treat following liquid / hazardous / gaseous stream:

- Quench column bottoms (flow 1.5 m³/hr) containing ACN/Hydrogen cyanide/Acetonitrile & Acrolein
- Ammonium sulphate stream (flow 2 - 5m³/hr) ammonium sulphate & aqueous polymers
- Treating kettle bottoms
- Hydrogen cyanide vapours (during start-up & when no off-take by downstream plants)

Gas (Hydrogen & methane) is used as fuel for incinerator. LSHS is used a standby fuel. The temperature is maintained at 1600°C. The analysis result for incinerator off-gases is presented in Table 4.15.

Fugitive Emission

The process operating pressure is generally low and hence fugitive emission are generally low. Fugitive emission sources include leaks from pumps, compressors and valves. Considering the high toxicity of HCN / Acrylonitrile, numbers of measures have been taken to control fugitive emissions. These measures are summarised in **Table 4.16**. In addition to the above, on-line monitors are provided at 16 strategic locations for ACN and Hydrogen Cyanide. However, there are still number of pumps/valves in organic liquid service. The fugitive emissions from these sources are computed using the average emission factors of USEPA and component inventory data and presented in **Table 4.17**.

Table 4.15: Acrylonitrile Plant Stack Emissions (Unit – I)

Plant Operating Load: 85 TPD			
S. No.	Parameter	Stack connected to Wastewater Incinerator	
		Day 1	Day 2
1	Stack height (m)	52	52
2	Stack diameter (m)	2.0	2.0
3	Fuel used	GAIL Gas	GAIL Gas
4	Fuel quantity (Kg/hr)	465	465
5	Temperature (°C)	327	327
6	Velocity (m/s)	22	22
7	Flow rate (m ³ /hr)	2,48,400	2,48,400
Parameter concentration			
a)	NO _x (ppm)	41.60	35.4
b)	NH ₃ (mg/Nm ³)	--	--
c)	HCN TPD (mg/cum)	0.023 (3.915)	0.011 (1.81)
d)	SO ₂ , (mg/m ³)	31.2	25.4
e)	Acetonitrile TPD (mg/m ³)	Traces	Traces
f)	Acrylonitrile TPD (mg/m ³)	Traces	Traces

Table 4.16: Fugitive Emission Prevention – Acrylonitrile (Unit – I)

Equipment	Type	Service
Pumps	Seal less pumps (make Nikkiso) cost 3 times ordinary pump	HCN/ACN
Valves	Inside Opening Stem Valves (make STRAMEN) with Teflon Packing	HCN

Equipment	Type	Service
Flanges	Plane Faced with Teflon packing	--
Compressors	Tandem Seal	--

Table 4.17: Component Fugitive Emission – Acrylonitrile (Unit - I)

Component	Nos.	Service	Emission Rate		
			(kg/hr)	TPD	TPA
Valves	512	Light liquid service (LL)	3.635	0.0872	28.72
Pump Seals	16	LL	0.7904	0.019	6.26
Flanges / Screwed fittings	2219	LL	1.842	0.044	14.58
Open ended lines	24	LL	0.0408	0.00097	0.32
Pressure Relief Valves	16	LL	1.664	0.04	13.17
			7.972	0.1911	63.06

4.10 Emission from Phthalic Anhydride

Combustion Source

The heat evolved during the reaction is sufficient to meet the entire electric power and steam requirements of the unit. The only source of combustion is the process heater provided to heat the thermic fluid. This uses both Furnace oil & heavier fraction from PA purification as fuel.

Process Vents

The only source of air pollution from phthalic anhydride plant are the gases leaving from switch condenser since the gases evolved have organic acids (which can be removed by water scrubbing), three stage scrubber (packed bed type) is provided on the vent.

Monitoring data for phthalic anhydride scrubber vent are provided in Table 4.18. As can be seen, the scrubber is useful to control the organic acid concentration, but is of no use to control carbon monoxide emitted during the oxidation stage.

Fugitive Emissions

The principal raw material (o-xylene) has a high boiling point (144°C) and poses no special health hazards. Phthalic anhydride also has a high boiling point

(295°C). Thus, no special precautions are taken except at oxidation reactor where the heat evolved requires stringent control to prevent leakages. Generally, o-xylene pumps in large units are single mechanical seal type.

Table 4.18: Analysis results of Phthalic Anhydride Absorber Vent (Unit- VI)

Temperature	51°C
Flow	56520 Nm ³ /hr
Total Organic Carbon (TOC)	99 mg/Nm ³
Maleic acid	70 mg/Nm ³
Citraconic acid	15 mg/Nm ³
Benzoic acid	10 mg/Nm ³
o-Toluic acid	2 mg/Nm ³
o-Toluic anhydride	2 mg/Nm ³
CO	5750 mg/Nm ³

4.11 Emission from Dimethyl Terephthalate

Process Vents

The main source of air pollution is the off-gas from oxidation stage, which is passed through carbon adsorbers to reduce the VOC emissions. The off-gases were analysed before / after adsorber to check the organics content. The results of analysis are presented in Table 4.19.

Table 4.19: Analysis results of Adsorber off-gas Analysis (Unit – VII)

Temp	51°C
Flow	45000 Nm ³ /hr
Methanol	437 mg/Nm ³
Xylene	308 mg/Nm ³
CO	5612.5 mg/Nm ³

Note: All results corrected to 3% oxygen

4.12 Emission due to transfer operations

The principal method of transferring liquid product to tank trucks and railcars is submerged loading, including submerged fill pipe loading and bottom loading. In submerged fill pipe loading, the fill pipe enters the vessel from the top but extends almost to the bottom to the vessel such that the fill pipe opening is completely submerged in the liquid product. In bottom loading, the fill pipe enters the vessel from the bottom, so that the fill pipe opening is positioned

below the liquid level. Both submerged loading techniques significantly reduce turbulence and liquid surface area resulting in low vapour generation.

Top splash loading, rarely used in SOCFI facilities, is another loading technique in which the fill pipe enters the vessel through the top but extends below the surface of the liquid. This type of loading results higher vapour generation.

The loading rack is the equipment used to transfer materials into tank trucks and railcars. The loading rack and transfer vehicle are emission points during loading operations. A typical loading rack consists of loading arms, pumps, meters, shutoff valves, relief valves, and other associated piping necessary to perform either loading or unloading operations.

4.12.1 Emissions during tanker loading

Benzene is a 'high' risk chemical & has very high toxicity. A large variation was seen in tanker loading practices adopted at individual units shown in **Table 4.20**.

Table 4.20: Tanker Loading Practices – Benzene

Unit Name	Tanker Loading Practice
Unit – VIII	Loading arm has compatible vapour tight adaptors. Closed vent passes through condenser / activated carbon.
Unit – IV	Loading arm has compatible vapour tight adaptors. Closed vent passes through condenser (to cool gases to 10°C) & activated carbon beds.
Unit – I	Loading Manhole open. Dip taken through open manhole. Vents to atmosphere. No protection to workers
Unit – II	Loading manhole covered. Vent provided on manhole taking benzene vapours away from breathing zone.
Unit – V	Loading arm has compatible vapour tight adaptors. Closed vent passed through chilled slop oil scrubber before discharge to atmosphere.

Monitoring of Benzene levels during Tanker Loading:

Monitoring of Benzene levels was carried out for following situations:

- Work Area Monitoring - (No vapour collection / control device provided)

- Monitoring to find control system efficiency and to find workroom monitoring levels during loading with system ON.
- a) Work area Monitoring - (No vapour collection / control device provided)

Samples were collected and analysed using short-term dragger tubes and using tenax tubes which were later thermally desorbed and analysed on GC. Range of values observed are given below:

Table 4.21: Work Area Benzene Monitoring Levels near Tanker Loading Bay (Situation: No vapour collection / Control device provide) (Unit – V)

S. No.	Location	Value Range (ppm)	Permissible Standards (ppm)	
			TWA	STEL
1	Tanker Top (*) (Breathing level)	20 – 80	1	5
2	Tanker West side at Ground level (+)	0.5 – 5	1	5
3	Tanker East side at Ground level (+)	1 – 3	1	5

Note : (*) values vary with height from open manhole / wind speed & direction

(+) values vary with wind direction & speed & nature of enclosure

- b) Monitoring with vapour collection system ON

Samples were also collected at inlet / outlet of scrubber system at RIL, Patalganga after connecting the tanker to vapour collection system.

Table 4.22: Monitoring at Tanker loading Bay Emission Control System (Unit – V)

S. No.	Location	Sample Concentration (kg/hr)			Ambient levels at tanker top (ppm)
		Inlet to Scrubber	Outlet to Scrubber	Efficiency (%)	
1	Day 1	4.69	1.02	78.2	2 – 4
2	Day 2	3.86	0.18	95.3	0 - 0.5

As can be seen levels at tanker top reduced appreciably after connecting to the vapour collection system. The variations in efficiency of control system maybe because no blower is provided to suck the benzene emissions and benzene vapours are taken to the scrubber only due to displacement.

4.13 Storage Emission

4.13.1 Storage emission from ethylene and propylene plant

Ethylene, propylene and butylene are gases at normal temperature and pressure, hence are stored under pressure in spheres. Generally, these are used within the complex for manufacture of polyethylene and/or other downstream chemicals or supplied to neighbouring units manufacturing downstream chemicals. The storage spheres and road tankers are vapour balanced as also vapour balancing of storage tanks is done with each other in order to ensure minimum losses. The nitrogen vent and pressure releases from the tanks are taken to flare system. Some plants have made efforts to recover boil-offs during loading / unloading into spheres to the process stream by providing separate compressor. Flare system for storage are generally provided separately from the process flare.

The naphtha and other liquid hydrocarbon intermediates are stored in fixed / floating roof tanks and are sources for emission losses. Storage practices for liquid hydrocarbons in Indian Industry are presented in Table 4.23.

Table 4.23: Storage Practices for Liquid Hydrocarbons

Plant	Types of Storage			
	Naphtha	Aromatic rich stream	Pyrolysis Gasoline & C ₅	Other liquids
Unit - I	External Floating Roof (EFR)	Vertical Fixed Roof (VFR)	VFR	VFR
Unit - VIII	EFR	Internal Floating Roof (IFR)	Dome Roof (DR)	VFR
Unit - IV	EFR	EFR	DR	VFR

As can be seen the recent trend in industry is to have more control where highly volatile / highly toxic chemicals (such as aromatics) are being handled.

4.13.2 Storage emission from butadiene

Butadiene undergoes dimerization as storage temperature increases. Hence it is essential to store butadiene at a low temperature. Also, butadiene reacts readily with oxygen in air to form polymeric peroxides & therefore following precautions are taken:

- Antioxidants are added
- Stored under N₂ pressure

Hence butadiene is generally stored under pressurized condition at low temperatures under N₂ blanket in spheres and no losses are expected from the storages. The Nitrogen vent and pressure releases from the tanks are generally taken to the flare. The storage tanks vapour balance with each other and with the road tankers & hence no loading / unloading emissions are expected to occur.

Losses of hydrocarbon vapours may take place however from the solvent storage system.

4.13.3 Storage emission from benzene plants

Storage practices seen at various units for Benzene are as presented below :

Table 4.24: Storage Practices for Benzene

Unit Name	Storage Type
UNIT-VIII	Internal floating roof tank
UNIT-IV	External floating roof tank with double seals
UNIT-I	Vertical fixed roof
UNIT-II	Vertical fixed roof
UNIT-V	Vertical fixed roof with nitrogen blanketing. Breather valve to atmosphere. In day tanks- internal floating roof provided with N ₂ blanket to reduce emission.

The emissions from storage tanks of benzene were computed using TANKS software of USEPA for various units. As observed, the emissions from vertical fixed roof tank due to breathing / filling are much higher (about 20 TPA for a tank of 1000 T capacity) than that for a internal floating roof tank (about 0.6 TPA for a tank of 2000 T capacity).

4.13.3.1 Monitoring of emission from benzene storage tanks

Three types of samples were taken:

- Underground tank during filling / breathing
- Above Ground tank during filling / breathing
- Internal floating roof tank during filling / breathing

Samples during tank filling were collected using specially designed sampling train. Results of analysis are presented below:

Table 4.25: Monitoring of Emission During Tank Filling

Type of tank	Volume loaded (L)	Time (min)	Vapour Emitted	
			(kg/hr)	(kg/ton)
Above Ground	19380	38	5.0	0.208
	19576	35	6.71	0.26
	19565	35	6.80	0.26
Under Ground	19960	42	6.70	0.30
	23154	45	7.7	0.31
	18927	40	5.64	0.16
Internal Floating Roof	1350	135	0.00089	0.0018
	2100	120	0.00121	0.0024

It is observed from the above that benzene emitted from above ground / under ground storage tanks during filling is in the range of 5 – 7 kg/hr whereas that emitted from IFR is only about 0.001 kg/hr. Similarly, emission expressed per Ton of Benzene filled also shows similar trend.

Monitoring data for tanks during breathing conditions are presented in **Table 4.26**.

Table 4.26: Monitoring of Emission during Tank Breathing

Types of Tank	Vapour Emission (mg/hr)	Ambient Temp. (°C)
Above Ground	0.523	32
	0.737	33
	2.029	38
Under Ground	N.D.	34
	N.D.	38
Internal Floating Roof	0.002	34
	N.D.	34

Emissions during breathing are much lower than that during filling. Also, it is seen that there are practically no breathing emissions from Underground tanks / Internal floating roof tanks.

4.13.4 Storage emissions from EO

EO is a gas at ambient temperature and is stored under pressure or by using chilling arrangements in liquefied form. Safety Relief valves (SRV's) with upstream rupture discs are provided on storage tanks, which vent to a water scrubber during emergencies. Losses can occur in handling EO during transfer from storage tank to road tanker. It is seen that most of the companies have provided arrangement to vent displaced exhaust gases from road tanker (during filling of road tanker) & these are directed to a water scrubber. Additional handling losses during transfer from EO storage to road tanker correspond to possible hold up in the transfer pipe. Storage emissions from MEG/DEG tanks are calculated using TANKS software of USEPA and using actual meteorological data from IMD is presented in **Table.4.27** below. It is seen that emissions are very low due to high boiling point / low volatility of the glycols.

Table 4.27: Storage Emissions – EO/EG plant

S. No.	Plant	Tank Contents	Tank Nos.	Capacity M ³	Turn-over (No. / Yr / tank)	Storage Emissions TPA	
						Working losses	Breathing losses
1	UNIT-I	MEG	2	33.5	330	0.0022	0.00038
2	UNIT-II	MEG	2	1000	22	0.172	0.00812
3	UNIT-II	MEG	2	35	363	0.0022	0.000025
4	UNIT-II	MEG	2	600	22	0.0094	0.00221

4.13.5 Storage emissions from ethylene dichloride (EDC)

Ethylene dichloride emissions result from the storage of EDC during the process and final product stages. In the old plants, EDC is stored in vertical fixed roof tanks at ambient temperature and pressure. Pure EDC and wet EDC is stored in dome-roof tanks in one unit. In new plants all tanks of Vertical Fixed Roof type. They have provided a closed loop recycle system, where cooled EDC is fed to the educator along with vapour EDC from strong tanks for absorbing the vapour. Liquid EDC is collected in storage tank and recycled. Uncondensed vapours are diverted to incinerator. The emissions are calculated for fixed-roof tanks and using meteorological data obtained from IMD, using Tanks software of the USEPA and are presented in Table 4.28. The total storage losses (working & breathing) for storages are calculated to be 36.45 TPA.

Vinyl Chloride monomer however occurs as a gas and is liquefied & stored under pressure & Nitrogen blanket. Alternately, the tanks maybe refrigerated at ambient pressure. The spheres are pressure balanced with each other and with road tankers. Hence emissions from VCM storage can occur only from safety valve discharge, which is routed, to incinerator in the new plants.

Table 4.28: Storage Emissions of EDC Plant (Unit – I)

S. No.	Tank Contents	Tank Nos.	Capacity M ³	Turn-over (No. /Yr / tank)	Storage Emissions TPA	
					Working losses	Breathing losses
1	EDC	1	300	88	- (+)	0.514
2	EDC	1	390	264	6.92	1.44
3	EDC	2	500	66	21.86	4.74
4	EDC	4	120	176	- (+)	0.98
				Total	28.78	7.67

Note: (+) Tank level remains constant as used as intermediate feed tanks.

There is generally no chlorine storage in the EDC / VCM plants as it is provided by a associated chlor-alkali plant. Storage of liquefied dry HCl is generally in closed system pressurized vessels at low temperature.

4.13.6 Storage Emissions from ACN

Acrylonitrile and Acetonitrile are stored in Vertical Fixed Roof tanks under Nitrogen blanketing. Due to its high toxicity, HCN is not stored in the facility. The emissions are calculated using TANKS 4.08 - a software developed by Environmental Protection Agency (EPA) based on loss calculation formula developed by American Petroleum Institute (API) and presented in **Table 4.29**. Meteorological data from IMD, was used as feed to the software. As can be seen total acrylonitrile emissions from storage are estimated at 57.78 TPA and total acetonitrile emissions from storage at 1.1017 TPA.

The acrylonitrile produced is sent to downstream acrylic fibre plant directly by pipeline and hence no major emission during tanker loading take place.

Table 4.29: Storage Emissions of ACN Plant (Unit – I)

S. No.	Tank Contents	Tank Nos.	Capacity MT	Turn-overs (No. /Yr / tank)	Emissions TPA	
					Working losses	Breathing losses
1	ACN	2	600	55	23.22	6.18
2	ACN Crude	2	300	88	14.72	2.96
3	ACN Rundown	4	72	84	8.724	1.976
4	Acetonitrile	1	120	10	0.35	0.42
5	Acetonitrile –Crude Tank	1	15	67	0.178	0.069

4.13.7 Storage emissions from xylene

o-Xylene is generally stored in vertical fixed roof tanks provided with breather valves. Due to the high boiling point & low hazard potential of o-xylene no special precautions are taken for storage.

4.13.8 Storage emissions from DMT

To control emission from storages, the following precautionary steps were seen.

- Day tanks for oxidate storage & methanol storage were connected to scrubber.
- Fixed roof storage tanks were provided for methanol storage tank
- Pressure relief valves were connected to a Methanol recovery column through a common header.

Generally two types of storage vessels are of concern in a petrochemical facility *i.e.* fixed-roof storage vessels (*i.e.* with no internal floating roof) and floating roof storage vessels. They are exclusively above ground and cylindrical in shape with the axis perpendicular to the foundation. There are also horizontal tanks; these are generally smaller and not as widely used.

4.13.9 Fixed-roof storage vessel

A typical fixed-roof vessel is a cylindrical steel shell with a cone or dome-shaped roof permanently affixed to it. Losses from fixed roof tanks are caused by

changes in temperature, pressure and liquid level. Fixed roof tanks are either freely vented or equipped with a pressure/vacuum vent. The latter allows the tank to operate at a slight internal pressure or vacuum to prevent the release of vapours during very small changes in temperature, pressure or liquid level. Hatches / sample wells, float gauges, and roof manholes on the fixed roof, which provide access to these tanks, also are potential but less significant sources of emissions.

Two significant types of emissions from fixed roof (FR) tanks are storage and working losses. Storage loss / standing loss is the expulsion of vapour from a tank through vapour expansion and contraction, which are the result of changes in temperature and pressure. This loss occurs without any liquid level change in the tank. The combined loss during filling and emptying is called working loss.

Fixed roof tank emissions vary as a function of vessel capacity, vapour pressure of the stored liquid, utilisation rate of the tank and atmospheric condition at the tank location. Computation method/formulae are available, the EPA model TANKS can be used to determine the losses from FR tanks.

Emission control techniques available for fixed roof tanks include:

- Installing an internal floating roof and seals to minimise evaporation of the product being stored (efficiency 60-99%).
- Vapour balancing (vapours expelled during filling of storage tank are directed to the emptying tanker truck. The truck then transports the vapour to a centralized station equipped with a vapour recovery/control system. (Control efficiency 90-98%).
- Vapour Recovery System (collects emissions from storage vessels and converts them to liquid product. Techniques used include vapour /liquid absorption, vapour compression, vapour cooling, vapour/solid adsorption or combinations. (Control efficiency 90-98%).

4.13.10 Floating roof storage vessel

A floating roof vessel is a cylindrical steel shell equipped with a disk-shaped deck with a diameter slightly less than the inside tank diameter. The floating deck floats freely on the surface of the stored liquid, rising and falling with the liquid level. The liquid surface is completely covered by the floating deck, except in the small annular space between the deck and the shell. A rim seal attached to the floating deck slides against the vessel wall as the deck is raised or lowered, covering the annular space where the deck is not covering the liquid. The primary function of the rim seal is to prevent emissions.

4.13.10.1 External floating roof (EFR) vessel

An EFR vessel does not have a fixed roof; instead, its floating deck is the only barrier between the stored liquid and the atmosphere. An EFR vessel may have several types of rim seals and deck fittings that penetrate the deck and serve operational functions. The external floating roof design is such that evaporation losses from the stored liquids are limited to losses from the rim seal system and deck fittings (standing storage loss) and any exposed liquid on the tank walls (withdrawal loss).

4.13.10.2 Internal floating roof (IFR) vessel

An IFR vessel is equipped with a permanently affixed roof above the floating deck. There are two basic types of internal floating roof tanks (i) tanks in which fixed roof is supported by vertical columns (ii) tanks with self supporting fixed roof. The deck in internal floating roof tanks rises and falls with the liquid level and either floats directly on the liquid surface (contact deck) or rests on pontoons several inches above the liquid surface (no contact deck). Evaporative losses from floating roofs may come from deck fittings, non-welded deck seams, the annular space between the deck and tank walls. The tanks are generally freely vented by circulation vents at the top of fixed roof, to minimise formation of explosive mixture in the vapour space.

4.13.10.3 Emissions from floating roof tanks

Total emissions from floating roof tanks are the sum of withdrawal losses and standing storage losses. Withdrawal losses occur as the liquid level and thus the floating roof is lowered. Some liquid remains on the inner tank wall surface and evaporates. For an internal floating roof tank that has a column-supported roof, some liquid also clings to the columns & evaporates. Evaporative losses occur until the tank is filled and the exposed surfaces are again covered. Standing storage losses from floating roof tanks include rim seal, deck fitting losses and for internal floating roof tanks also include deck seam losses for constructions other than welded decks.

Other potential standing loss mechanism includes breathing losses as a result of temperature & pressure changes from the rim seal system and at the deck fittings. The majority of rim seal losses are wind induced. The rim seal system may consist of just a primary seal or a primary & a secondary seal, which is mounted above the primary seal.

The primary seal serves as a vapour conservation device by closing the annular space between the floating deck & the wall. Three basic types of primary seals are used on external floating roof tanks: Mechanical (metallic) shoe, resilient

filled (non metallic) & flexible wiper seals. The primary seals are sometimes protected by a weather shield, which protect the primary seal fabric from weather, debris and sunlight. A secondary seal may be used to provide some additional evaporative loss control over that achieved by the primary seal. Secondary seals can be either flexible wiper seals or resilient foiled seals. The secondary seals maybe placed in two configurations viz. rim mounted and shoe mounted. Rim mounted secondary seals are more effective in reducing losses than shoe mounted secondary seals as they cover the entire rim vapour space.

4.14 Flares

Flaring is a volatile organic compound (VOC) combustion control process in which the volatile organic compounds are piped to a remote, usually elevated location and burned in a flame in the open air using a specially designed burner tip, auxiliary fuel, and steam or air to promote mixing for nearly complete destruction of VOC (> 98%). Completeness of combustion in a flare is governed by flame temperature, residence time in the combustion zone, turbulent mixing of the components to complete the oxidation reaction and available oxygen for free radical formation. Combustion is complete if all volatile organic compounds are converted to carbon dioxide and water. Incomplete combustion results in some of the volatile organic compounds being unaltered or converted to other organic compounds such as aldehydes or acids.

The flaring process can produce some undesirable by-products including noise, smoke, heat radiation, light, SO_x , NO_x , CO and an additional source of ignition where not desired

4.14.1 Flare from cracker furnace

All crackers are provided with flare gas systems to allow safe disposal of any hydrocarbons that cannot be recovered in the process. During startup, in a continuous process, it becomes a need of the process to vent the hydrocarbon holdup till the plant stabilises giving desired output. Also, during emergencies which maybe due to pressure or any other reason, it becomes necessary to vent the hydrocarbons. Considering the flammable nature of the hydrocarbons all such releases (start up & emergencies) are taken to the flare. Shut down operations can be classified into two categories i.e. normal shut down and emergency shutdown. During emergency shutdown it maybe necessary to flare the contents of units taken up for maintenance. Similarly, storage tanks of gaseous hydrocarbons are cryogenic in nature and a secondary flare (low pressure) is provided to take care of any refrigerent released in emergencies. The primary role of flare system is therefore to ensure safety, by preventing build-up of flammable hydrocarbon mixtures in the manufacturing area.

Generally, two flares are provided

- One elevated flare for the fugitive losses & shutdown – startup losses
- One low pressure flare for the cryogenic storages.

Generally, the flare monitoring is done by closed circuit television (CCTV) system having its output in the cracker control room. Motorised valves are provided on steam lines to have better control on steam mixing rate. The plants have an automatic trip arrangement in case the flare is put off. Observations on flares provided by various petrochemical units are summarised in Table 4.30. Generally, it is seen that stack height are adequate as these have been provided as per relevant API standards by all units. As can be seen only one unit Unit - IV, has a 30% smokeless capacity, while all other units have much less smokeless capacity. Also, Unit – IV has implemented a flare gas recovery system to recover gases going to flare. However, smoky/noisy/luminous flares are some of the problems observed in the industry.

Table 4.30: Comparison of Elevated Flares in Petrochemical Units

Company	Max. Cap (TPH)	Smokeless Cap.(TPH)	Height (m)	Observation
Unit -I	730	40	120	<ul style="list-style-type: none"> • Smoky (sometimes) • Large flame • Visual check closed circuit television • Motor operated valve - Steam line • 4 Pilots-Ensure Ignition
Unit –IV	1100	300	115	<ul style="list-style-type: none"> • Non-luminous • Very low-flame • Controls as above
Unit -VIII	800	--	120	<ul style="list-style-type: none"> • Highly Smoky • Controls as above
Unit –III	714	84	100	<ul style="list-style-type: none"> • Very low flame • Controls as above
Unit –IX	686	--	100	<ul style="list-style-type: none"> • Very large flame • Smoky / Noisy • Controls as above

4.15 Fugitive emissions from equipment leak

Fugitive emission from equipment leak (especially VOCs) i.e. diffused emissions (compressors, pumps) and fitting (flanges, valves) play a major role in petrochemical plants. The chief source of VOC emission during normal operation is the charge gas compressor lubricating oil vent. Fugitive emission may also occur from cooling water contaminated with process stream through cooling tower and volatile organic compounds from wastewater treatment. The following is a brief description of the types of equipment from which fugitive emissions are generated, where the emissions occur, and what equipment changes can be made to reduce or eliminate these emissions.

a) Connectors

The most numerous component in a plant is the connector, which is used to connect piping to other piping or to equipment. Flanges are connectors consisting of gasket-sealed junctions that are used on pipe with a diameter of ≥ 2 in. Flanges may leak because of improperly selected gaskets or poor assembly. Other types of connectors are generally used on smaller-diameter pipe. Threaded connections, which leak when cross-threaded, are an example. Another type of small pipe connector is a nut-and-ferrule connection, which leaks when poorly assembled. All types of connectors are subject to thermal deformation and may leak as a result. Connectors and their associated emissions can be eliminated in some cases through the use of welded joints.

b) Valves

It is no surprise that in equipment with moving parts, releases generally occur around the moving part. Packing, which is subject to degradation, is often used around such parts to form a seal between the process fluid and the atmosphere. The expertise of the person performing the valve installation and the quality of the valve manufacturing process both affect valve leak rates. Valves with bent or nicked stems cannot be relied on to perform reliably in terms of leaks, and in these cases at least the stem must be replaced. Valve packing technologies that use rings to keep the packing from extruding and springs to maintain the packing under constant pressure (and thus in constant touch with the stem) have been developed. These systems can reduce leak rates and operate without maintenance for 10-50 times as long as valves with conventional packing.

There are two main types of "seal less" or "leak less" valves that have no emissions through the stem. They are bellows valves, which are expensive and used mostly in the nuclear power industry, and diaphragm

valves, which separate the valve stem from the process fluid through the use of a diaphragm. The diaphragm in some designs, serves as the flow control device in addition to forming a barrier between the stem and the process fluid. If a diaphragm fails, emissions result, and packing is sometimes used as a backup for the diaphragm. Repair of a faulty diaphragm cannot be made without removing the valve from service. It can be difficult to replace conventional valves with leak less technology if there are significant spaces constrains.

c) Pumps

As with valves, emissions from pumps occur largely around the moving parts; releases occur where the pump shaft meets the stationery casing. Packed seals are used, but well maintained mechanical seals generally leak less. However, mechanical seals are costly and time-consuming to repair, and sudden failure of a mechanical seal can result in large emissions. Because of this, mechanical seals are often backed up by either more mechanical seals or packed seals. When dual mechanical seals are used, a barrier fluid may be circulated between the seals to further reduce fugitive emissions. This barrier fluid must be treated to remove process fluid. **Table 4.31** shows that leakage indices for various types of pump seals vary by many orders of magnitude. Mechanical seals for pumps have improved greatly in the last few years and are a viable alternative to leak less technology in a wide variety of applications.

Seal less designs for pumps include the canned motor pump, where the pump bearings run in the process fluid; and the diaphragm pump, where a flexible diaphragm is used to drive the process fluid. There are also magnetic drive pumps in which the impeller is driven by magnets.

Table 4.31: Leaking indices for a centrifugal pump with different types of seals

Seal type	Leakage Index
Packing with no sealant	100
Packing with sealant	10
Single mechanical seal, flushed	1.2
Tandem seal	0.15
Double seal	0.004

Note: Source: USEPA

d) Compressors

Compressors are similar to pumps in that they generally have rotating or reciprocating shafts. Like pumps, they move process fluid, but it is in the form of a gas instead of a liquid. Again packed and mechanical seals are used, but the use of packed seals is largely restricted to reciprocating compressors. Mechanical seals for compressors are not necessarily of the contact design used for pumps. Restrictive carbon rings and labyrinth-type seals that are composed of interlocking teeth are also used. Another type of seal used in compressors is a liquid film seal, in which an oil film is placed between the rotating shaft and a stationary gland.

e) Pressure Relief Devices

Pressure relief devices are used to prevent operating pressure from exceeding the maximum allowable limit of the equipment. One type of pressure relief device is a valve that opens when the operating pressure exceeds a certain limit and closes when levels are safe again. These valves can leak because they did not reseal properly or because the operating pressure is near their limit and they are "simmering" (popping open and closed). Another type of pressure relief device is the rupture disk, which is leak less under normal operation. A rupture disk bursts when the operating pressure exceeds its limit, allowing process fluid to escape until a new disk is installed. Rupture disks can be mounted upstream of pressure-relief valves to eliminate emissions from poorly seated valves. Careful equipment design and proper process operation corrects the problem of simmering relief valves. Some pressure-relief valves have an improved "soft" seat that seals better on reseating.

f) Open Ended Valves/Lines

Another class of components from which fugitive emissions originate is open-ended valves and lines. Drain valves, purge valves, and vent valves fall into this category. Process fluids leak when the valves are in poor repair or not fully closed. A pipe plug, cap, or blind flange can be installed over the open end to prevent emissions, or a second valve can be installed.

g) Sampling Systems

Sampling systems are used to verify that a process unit is operating properly. They must be purged before sampling in order to obtain a representative sample. If the purge stream is drained to the ground or sewer, it is an episodic fugitive emission. The purge stream can be

eliminated by modifying the sampling system so that the purge stream is round back to the process; such sampling systems are called closed-loop sampling system.

4.15.1 Estimating Fugitive Emission

The EPA indicates that there are five methods for estimating emissions from equipment leak from a chemical processing unit.

- Average emission factor methods
- Leak /no leak emission factor method
- Three strata emission factor method
- Application of EPA correlations.
- Development of new correlations

All methods start with obtaining an accurate identification and count of equipment to be included in the emission estimate. The equipment count can simply be used with the EPA’s emission factors. **(Table 4.32)**

- Liquid are classified based on most volatile components present @ > 20 % weight.
- If components have total Vapour Pressure ≥ 0.04 psi @ 20⁰ C, the material (containing $\geq 20\%$ VOC) is classified as light liquid.
- All above to be checked at process conditions and not ambient conditions.

The next step in complexity and refinement is the use of a portable organic vapour analyser to find the number of leaking and non-leaking sources. (A leaking source is one whose screening concentration is greater than or equal to 10,000 ppmv.) The data on number of leaking/non leaking components can be used with the leaking and non-leaking emission factors previously developed by the EPA **(Table 4.33)**

Table 4.32: Average Emission Factors for Fugitive Emissions

Equipment	Service	Emission factor (kg/hr/source)
Valves	Gas	0.0056
	Light Liquid	0.0071
	Heavy Liquid	0.00023
Pump Seals	Light Liquid	0.0494

Equipment	Service	Emission factor (kg/hr/source)
	Heavy Liquid	0.0214
Compressor Seals	Gas/Vapour	0.228
Pressure Relief Valves	Gas/Vapour	0.104
Flanges	All	0.00083
Open-Ended Lines	All	0.0071
Sampling Connections	All	0.0150

Note: Source - USEPA

Table 4.33: Leaking and Non-Leaking Emission Factors for Fugitive Emissions (kg /hr source)

Equipment	Service	Leaking ($\geq 10,000$ ppm) Emission Factor	Non-leaking ($< 10,000$ ppm) Emission Factor
Valves	Gas	0.0451	0.00048
	LL ^a	0.0852	0.00171
	HL ^b	0.00023 ^c	0.00023
Pump Seals	LL	0.437	0.0120
	HL	0.3885	0.0135
Compressor Seals ^d	Gas	1.608	0.0894
Pressure Relief Valves	Gas	1.691	0.0447
Flanges	All	0.0375	0.00006
Open-Ended Lines	All	0.01195	0.00150

Note:

Source : USEPA
 LL^a : Light liquid service.
 HL^b : Heavy liquid service.

0.00023^c : Leaking emission factors assumed equal to non-leaking emission factor since computed leaking emission factor (0.00005 kg/hr/source) was less than non-leaking emission factor.

Compressor Seals^d : Emission factor reflects existing control level of 60 percent found in the industry; control is through the use of barrier fluid/degassing reservoir/vent-to-flare or other seal leakage capture system.

A final refinement is a method employing discrete emission factor that is applying emission factors to represent three different ranges of screening values. This has been called the stratified emission factor approach or the three strata approach. The stratified emission factors for equipment leaks are presented in **Table 4.34**

Table 4.34: Stratified Emission Factors for Equipment Leaks (Kg/Hr/Source)

Source	Service	Emission Factors (kg/hr/source) for Screening Value Ranges, ppmv		
		0-1,000	1,001-10,000	Over 10,000
Compressor seals	Gas / vapour	0.01132	0.264	1.608
Pump seals	Light liquid	0.00198	0.0335	0.437
	Heavy liquid	0.00380	0.0926	0.3885
Valves	Gas / vapour	0.00014	0.00165	0.0451
	Light liquid	0.00028	0.00963	0.0852
	Heavy liquid	0.00023	0.00023	0.00023
Flanges, connections	All	0.00002	0.00875	0.0375
Pressure relief devices	Gas / vapour	0.0114	0.0279	1.691
Open-ended lines	All	0.00013	0.00876	0.01195

Note: Source: USEPA

Applying the stratified emission factors requires more rigorous measurement of organic vapour concentrations with a portable instrument because actual

concentration reading must be recorded instead of noting whether a piece of equipment is classified as leaking or not leaking.

The remaining two methods make use of correlation equations relating mass emission to organic concentrations measured with a portable organic analyser. This is used in cases where the mass emission rates are statistically different from those represented by the EPA's emission factors correlations are then developed specifically for that process unit.

CHAPTER 5.0 CATEGORISATION OF VOCs

5.0 CATEGORISATION OF VOCs

5.1 VOC emissions from petrochemical / synthetic organics chemical manufacturing industries (SOCMI) / polymer processes

Major problems in petrochemical and related downstream *viz.* SOCMI / polymers are the generation of large amount of organic compounds released to air in the gaseous phase. Commonly called volatile organic compounds (VOCs), the aim in all processes is to prevent or minimise the release of VOCs. Because of the size, scope and nature of petrochemical plants; this presents a major challenge requiring an overall strategy that devolves into individual action at process unit and plant item level.

Sources of emission from each of the above processes are summarised & presented in Table 5.1.

5.2 Categorisation of volatile organic compounds

Organic Compounds due to their volatility are emitted into the atmosphere from a variety of industrial processes. The term volatile organic compounds (VOCs) cover a range of chemical classes including aliphatic, aromatic and chlorinated hydrocarbons, aldehydes, ketones, esters, acids and alcohols. They contribute directly or indirectly to a number of environmental issues and concerns, but the nature and extent of their contributions depend on the chemical structure of each individual compound.

Considering the wide variety of VOCs emitted into the atmosphere, it is felt that a system should be adopted for categorising the VOCs in terms of their environmental and health impact. Such categorisation of VOCs has been adopted by several countries in the world, notable amongst them being:

- German system of categorisation - where VOC's are classified into three categories.
- Italian system of categorisation – where VOC's are classified into five categories
- UK system of categorisation – where VOC's are classified into high / medium / low category

- The USEPA has identified 189 substances as hazardous air pollutants based on their toxicity properties.

5.3 Overview of environmental impact of volatile organic compounds

Volatile Organic Compounds (VOCs) are of serious environmental concern because of the harmful or offensive properties that they exhibit in varying degrees. These include:

- Harmful effects on human health & on natural ecosystems through toxicity, carcinogenicity and other adverse physiological effects.
- Damage to materials.
- Contribution to photochemical ozone creation at ground level with consequent harmful effects.
- Destruction of stratospheric ozone.
- Contribution to global climate change
- Sensory effects such as malodour.

5.3.1 Adverse physiological effects

Many volatile organic compounds (VOCs) are directly harmful to health on a broad spectrum of acuteness, and include irritation to skin and mucous membranes; various toxic and neurological effects; carcinogenicity, teratogenicity and mutagenicity. Some, such as Methane and Ethylene, are simple asphyxiants.

In addition, VOCs have an indirect effect on human health via the formation of photochemical oxidants such as ozone (see below). Ozone is an aggressive and reactive pollutant that has a number of damaging and adverse environmental effects on human health, vegetation and materials. Its main effect on humans is to cause a change in lung function, together with eye, nose and throat irritation.

Similarly VOCs have direct and indirect adverse effects on plants and animals, with general implications for the well being of natural ecosystems. With more persistent VOCs, there is potential for impacts on human health following transport via numerous possible environmental pathways, for example via sewer atmospheres or through contamination of the natural water cycle.

5.3.2 Damage to materials

Some volatile organic compounds (VOCs) have the potential to cause damage to materials close to their point of discharge, for example as a consequence of oxidising or corrosive properties. VOCs also indirectly contribute to damage to materials through the formation of ozone. Ozone is a highly reactive oxidising agent and can attack natural and synthetic rubber, textiles, and resins such as those used in surface coatings. Through attack on protective coatings, ozone damage can lead to accelerate building decay.

5.3.3 Photochemical oxidant production

Photochemical oxidant results from the reactions that occur between VOCs and oxides of Nitrogen (NO_x) in the presence of sunlight. Photochemical oxidants include ozone, peroxyacyl nitrates, peroxides *etc.* These compounds can affect human health and are harmful to plants and materials. They enhance environmental harmfulness of NO by oxidising it to NO₂.

The ability of a VOC to contribute to the formation of photochemical oxidants may be expressed by its photochemical Ozone Creation Potential (POCP) factors. The key references for POCP factors and their derivation and application are United Nations Economic commission for Europe (1990), Derwent & Jenkin (1991) and Richardson & Woodfield (1992).

5.3.4 Stratospheric ozone depletion

Concern over the effect of CFCs and other man made chemicals on the concentration of ozone in the stratosphere led to the Montreal Protocol and subsequent amendments.

- Methane has both natural and anthropogenic sources and affects both tropospheric and stratospheric ozone.
- Non-methane hydrocarbons - play a direct role in troposphere chemistry and an indirect role in stratospheric chemistry.

Chlorine-containing Substances - e.g. CH₃Cl, CHF₂Cl, CH₃CCl₃, - these gases also act as a source of ClO_x. ClO_x is an important intermediate in the break down of ozone in the stratosphere.

5.3.5 Global warming

Almost all VOCs have potential to contribute directly to global warming by absorbing infrared radiation from the earth's surface. In general the more

complex a VOC, the greater its ability to absorb infrared radiation, however, most VOCs have a very short atmospheric lifetime and are broken down by atmospheric reactions. Generally speaking the exceptions to this rule are the saturated light hydrocarbons and halogenated compounds. VOCs also contribute indirectly to global warming through the change in concentration of Ozone, which is a potent greenhouse gas.

5.3.6 Odour

Many Volatile organic compounds (VOCs) have an odour. In certain circumstances emissions of VOCs can give rise to localised odour nuisance problems. If subject to complaint, such a problem is usually treated as a statutory nuisance and becomes subject to health and safety regulations.

The strength of a given compounds odour may be expressed by its odour threshold that is the concentration at which half the population could not detect an odour. It is difficult to predict the odour threshold of a mixture of volatile organic compounds since there are often complex and non-linear synergistic effects that can alter both the strength and quality of the perceived odour. In such cases the odour threshold of the emitted mixture must be determined by practical measurement.

5.4 Criteria adopted for categorisation of volatile organic compounds

As is seen from Table 5.1, petrochemical and downstream processes under consideration emit a variety of volatile organic compounds. It was, therefore, felt that categorisation of VOCs will result in fixing priority for action.

A variety of methods of categorising VOCs can be envisaged.

The basis premise used for categorising VOCs was to evaluate the extent of their harmfulness. It was envisaged to have a simple approach at the present so as to aid implementation and so as to have a ready understanding of the basis of categorisation.

5.5 VOC Impact Data used in the Project

The following sections discuss the availability of suitable environmental impact data for each of the impacts. In each case, the section identifies the sources and nature of data, assesses its quality and indicates the extent of availability of the data at the moment. This section summarises the sources of data used in this project to compile and categorise the volatile organic compounds.

5.5.1 Adverse physiological effects

Adverse physiological effects on humans are evaluated in terms of acute and long-term toxic effects. Parameters used for acute toxicity are LD₅₀ (Oral), LD₅₀ (Dermal) and LC₅₀ (Inhalation) values. Parameters used for long term effects are carcinogenicity (classification as per IARC), mutagenicity and teratogenicity.

A number of publications provide data on the human health effects of volatile organic compounds. The prime source used was the registry of toxic effects of chemicals (RTECS) database – supplied as a CD-Rom from the Canadian Centre for Occupational Health & Safety (CCOHS). In addition, Saxs Dangerous Properties of Industrial Materials, Eighth Edition (Lewis, Sr.), was used.

Information on adverse physiological effects of VOCs on other biota (*i.e.* mammals, insects, birds, fish, plants *etc.*) is sparse. Even where information is available on, for example, LD₅₀ for fish, a wide variety of species have been examined and no one species is common to all such studies. The nature and strength of the effects is also diverse and varies between different species of a given taxonomic class. At the present time there appears to be no obvious way to take into account the effects of volatile organic compounds on biota other than humans.

For physico-chemical effects, the resulting hazards are: explosive, oxidising, extremely flammable, highly flammable and flammable. The latter are not regarded as measures of environmental impact and are considered irrelevant for the purpose of this study.

5.5.2 Damage to materials

Information on corrosiveness or other properties of volatile organic compounds, which might lead to materials damage, can be found in a variety of standard textbooks. However such damage is unlikely to occur at any distance from the point of discharge, due to dilution through dispersion. Potential for materials damage is therefore not included in the proposed categorization method for VOCs, although inclusion of POCP takes account of ozone formation that may lead to ozone attack on certain materials.

5.5.3 Photo-chemical oxidant production

It is well established that the photochemical degradation of hydrocarbons and other volatile organic compounds in the presence of nitrogen oxides leads to the production of ozone (O₃) and other harmful secondary pollutants (Atkinson, 1990; Lightfoot *et al.*, 1992). The complete gas-phase oxidation of organic compounds into CO₂ and H₂O occurs predominantly by sunlight-initiated mechanisms, driven by free radical reactions, with O₃ generated as a by-product. However, each VOC can contribute differently to the formation of O₃ and other

secondary oxidants in the troposphere, both in terms of quantity and timescale. Those compounds which are degraded rapidly (*i.e.* on the timescale of up to a few days) may be particularly important for efficient local O₃ production in the boundary layer, whereas those with lifetimes of a week or more are transported into the background troposphere where their slower oxidation has a less dramatic effect, even though they may ultimately be responsible for the production of more O₃ than those compounds which are degraded quickly.

Concern resulting from the generation of elevated levels of O₃ in regions of high population has led to more emphasis being placed on those compounds which are oxidized rapidly. Consequently, the reactivity of an organic compound with the hydroxyl radical (OH), the predominant initiation reaction, is commonly used as an indicator of its ability to contribute to photochemical air pollution. It is also recognized, however, that the nature of the oxidation steps following the initial attack by OH, have a (sometimes profound) influence on the resulting production of Ozone and other oxidants. Photochemical trajectory models, incorporating detailed degradation mechanisms for VOCs, have long been used to study the time-dependent production of photochemical oxidants in the boundary layer (Derwent & Hov, 1979), and these have been used to investigate the contribution to total O₃ formation made by a range of organic compounds (Derwent & Jenkin, 1991) on three trajectories over Europe. The concept of "Photochemical Ozone Creation Potential" (POCP) has been introduced to allow such contributions to be ranked. Based on trajectory model calculations over periods of up to 5 days from the points of emissions, POCP values have been assigned to nearly 100 non-methane volatile organic compounds, as indicators of the relative abilities of a unit mass emission of these compounds to produce O₃ on the given timescale.

The POCP scale indicates the relative abilities of VOCs to produce O₃ on short timescales (upto 5 days). Ethane (C₂H₄) is the reference compound, for which a POCP value of 100.0 is assigned. A POCP value is defined per unit mass emission. Currently calculated POCP values range from zero, for un-reactive fully halogenated compounds such as chlorofluorocarbons, to about 130 for reactive substituted aromatic compounds such as tri-methyl benzenes.

In assessing the utility of POCP for ranking harmfulness, the following considerations apply:

- POCP expresses a real difference between organic compounds in their capacity to help create ozone.
- POCP is a calculated quantity, which depends on the use of models and their underlying assumptions. When POCP is calculated using different

atmospheric models, the ratio of POCPs for any given pair of compounds may differ appreciably.

5.5.4 Stratospheric ozone depletion

The extent to which volatile organic compounds can contribute to depletion of ozone in the stratosphere is usually expressed in terms of ozone depletion potentials (ODPs). An ODP is a calculated quantity. To find the ODP for a particular compound, properties of that compound are put into a mathematical model. The model calculates the rate and height at which the compound interacts with other atmospheric constituents in the presence of sunlight, to initiate chains of reactions, which destroy stratospheric ozone. The ozone depletion arising from an instantaneous release of the compound is calculated for the whole of the life of the compound in the atmosphere. The depletion of stratospheric Ozone calculated for the compound is then expressed as a fraction of the depletion calculated for CFC-11 (tri-chloro-fluoro-methane), which is given an ODP of 1.0. The highest value encountered is for Halon-1301 (Tri-fluoro-bromo-methane) with an ODP of 12.

ODP is only associated with compounds containing the halogens - fluorine, chlorine, bromine and iodine; consequently the majority of VOCs are ascribed a zero ODP. ODP values are published by the World Meteorological Organisation (1994).

5.5.5 Global warming

The global warming potential (GWP) of a substance is a measure of the extra amount of heat that is trapped in the atmosphere when one kilogram of the substance is released instantaneously into it, relative to the case when 1kg Carbon dioxide is released.

GWPs are calculated using computer models, which incorporate the radiative heat balance of the atmosphere and the chemical kinetics of all the substances, involved. The model is initially in a steady state. If a kilogram of a greenhouse gas is released the temperature will increase until a new steady state is established. If a substance stayed in the atmosphere indefinitely the new steady state would be permanent and the increase in temperature could be used as a measure of the global warming potential. However, organic compounds are removed from the atmosphere by various processes including photochemical reactions and wet and dry deposition. In time, the concentration of the emitted substance will decline to zero and the initial state will be restored. Consequently a simple temperature increase cannot be used as a measure of global warming potential because it depends on time. Instead, the time integral of the increase in heat flux is used, normalised so that it equals unity for carbon dioxide.

Recently a paper has been published (Derwent, 1994) in which GWPs have been derived using a continuous source instead of an instantaneous one. The GWPs are very similar to those from the references using instantaneous one. (Ramaswamy *et al.*, 1991 and Shine *et al.*, 1990) sources so we have taken the average of all three references. Where values in the more recent IPCC report, Climate Change 1994, supersede these, the more recent values have been used.

The GWP of a compound includes a direct effect and an indirect effect. The direct effect is the warming due to the absorptions of radiation by molecules of the compound in question. The indirect effect is due to the impact that the presence of the compound has on the concentration of other greenhouse gases. The indirect effect can be negative if the molecule causes the removal of other greenhouses gases.

The integration is taken from the time at which the substance is released until a specified time in the future. GWPs are usually calculated for time horizons of 20 years, 100 years and 500 years. Various interest groups have proposed that one set of GWPs should be used over another, but no universal consensus has been reached. The GWPs calculated using the 100-year time horizon, have been used.

Because powerful computer models are needed, GWPs have only been determined for a handful of compounds, namely Carbon dioxide, Methane, Nitrous oxide, 5 Chlorofluorocarbons, 5 HCFCs, 4 Halons, Carbon tetrachloride, 1,1,1-Trichloro-ethane and Bromo-trifluoro-methane.

It is not possible to estimate GWPs on the basis of chemical intuition without using the sophisticated models mentioned above. Because there is no simple correlations exist between chemical structure and GWP. GWPs depend on the lifetime of the molecule in the atmosphere as well as the spectrum of the compound, and these lifetimes can vary greatly even among molecules.

5.5.6 Odour

Odour thresholds data are generally available from number of sources commonly referenced amongst these are:

Source 1: Fazzalavi (1978)

Source 2: Amoores & Hautala (1983)

Source 3: Woodfield & Hall (1994)

Source 1 provides listing of detection thresholds reported in literature between 1910 & 1976. Source 2 provides old literature data as also some calculated

values. Data reported in source 3 is the latest, which incorporates latest olfactometric methods.

However, odour data has a very high degree of uncertainty, which stems from the pseudo-subjective nature of the olfactometric methodology. Also, the values cannot be directly related to annoyance & / or to odour quality (pleasantness / unpleasantness) & hence odour data has not been used in the categorisation methodology.

5.6 Categorisation Method for Volatile Organic Compounds

A decision tree approach was used to judge VOC's against a number of selection criteria, which determine the category. Three categories were used which are termed as 'High', 'Medium' and 'Low' in descending impact. The decision tree approach is presented in **Fig 5.1**.

As can be seen, VOC's are first judged according to criteria based on human health effects, then on other factors viz. POCP / ODP / GWP. The three categories are summarised as follows:

High: IARC Group 1 or 2A OR Confirmed Mutagen or Teratogen OR MSI classification Extremely Toxic OR Very High Inhalation Toxicity (TLV value < 5 ppm)

Medium: IARC Group 2B OR MSI classification Highly Toxic or High Inhalation Toxicity (TLV Value > 5ppm & < 50 ppm) OR POCP >85 OR GWP >10 OR ODP >0.2

Low: IARC Group 3 / 4 and not toxic as per MSI rules and POCP < 85 AND GWP < 10 AND ODP <0.2

The classification for toxicity as given under MSI Rules (Manufacture, Storage and Import of Hazardous Chemicals) Rules 1989, as promulgated by the Ministry of Environment & Forests, Government of India, is as given below:

Category	Oral LD ₅₀ (mg/kg)	Dermal LD ₅₀ (mg/kg)	LC ₅₀ (mg/l)
Extremely Toxic	< 5	< 40	< 0.5
Highly Toxic	> 5-50	> 40-200	> 0.5 – 2.0
Toxic	> 50-200	> 200-1000	> 2-10

5.7 Findings in the study

Based on above criteria and using the decision tree in **Fig. 5.1**, various VOC's emitted from the petrochemical processes have been categorized and data presented in **Table 5.2**:

As can be seen, out of the 52 volatile organic compounds likely to be emitted from various petrochemical processes studied:

- 13 are High Priority
- 17 are Medium Priority and balance
- 22 are Low Priority

5.8 Reference

Important reference with reference to this Chapter is listed in Annexure – I.

Table 5.1: VOC Emissions in Petrochemical / SOCFI / Polymer Process

S. No.	Name of chemical / product	Type of Emissions	Pollutants expected
1.0	Ethylene / Propylene	<ul style="list-style-type: none"> • Oxides of Carbon & Nitrogen from incineration of waste gases, generation heaters & acetylene generation reactor • HC's during shut down & startup • Fugitive releases particulates & combustion products from decoking operations 	Ethylene, Propylene, Acetylene, CO & NOx
2.0	Butadiene	<ul style="list-style-type: none"> • Hydrocarbons from reactor & storage tank vents & during process plant decommissioning for maintenance 	Butylene, Butadiene
3.0	Benzene / Toluene /Xylene	<ul style="list-style-type: none"> • Charge gas & Refrigerator compressors 	Benzene, Toluene, o-, m- & p- Xylene

S. No.	Name of chemical / product	Type of Emissions	Pollutants expected
		<p>are potential sources of Hydrocarbons</p> <ul style="list-style-type: none"> • Furnace decoking, Acid gas removal & catalyst re-generation (do not have hydrocarbon emissions) • Fugitive emissions from Pumps, Valves, Compressors, Storage Tanks 	
4.0	Methanol	<ul style="list-style-type: none"> • Purge gas containing CO / CO₂/ CH₃OH & other hydrocarbons • Fugitive emission from pumps, valves, compressors, storages etc 	CO/CO ₂ / Methanol
5.0	Ethylene Oxide	<ul style="list-style-type: none"> • CO/CO₂ & HC from loop purges & CO₂ absorber vent • EO from the reactor analysis vent purification process and storage vent • Small amounts of EDC, used in small quantities to modify the oxidation reaction, are also released 	Ethylene oxide/ CO/CO ₂ /ethylene/Ethylene Glycol
6.0	Ethylene Glycol	<ul style="list-style-type: none"> • Vents & Purges from process streams 	Mono-, di-, tri-Ethylene glycol

S. No.	Name of chemical / product	Type of Emissions	Pollutants expected
7.0	EDC/VCM	<ul style="list-style-type: none"> Fugitive emissions of Chlorinated HC's from valves, flanges, & other minor sources Chlorinated HC's from storages Chlorinated HC's from Reactors, columns, vacuum, pumps, sampling system & waste water collection & treatment system VCM storage vent from monomer recovery and blanketing system Absorber vent containing Methane, Ethane, Ethane in EDC manufacture 	EDC, Ethyl chloride, Vinyl chloride, Ethylene Hydrogen chloride, Chlorine
8.0	Vinyl Acetate Monomer	<ul style="list-style-type: none"> HC's from reactor loop purge CO₂ Purge vent from absorption/desorption system 	Acetaldehyde, Ethylene, Acetic acid
9.0	Propylene Oxide/Glycol	<ul style="list-style-type: none"> Vent Gas Scrubber / Saponification column vent 	Propylene oxide, Propylene Glycol, Epichlorohydrin
10.0	Acrylonitrile	<ul style="list-style-type: none"> Product recovery Absorber vent / Recovery / Purification column vent Fugitive Emission from Pumps / Valves / Compressor etc. 	Acrylonitrile, Hydrogen cyanide, Acetonitrile Nitrogen oxides
11.0	Isopropanol	<ul style="list-style-type: none"> HC from tank & process vents & fugitive releases 	Acetaldehyde, Ethylbenzene, Acetophenone, Isopropylbenzene, Methyl ethyl ketone
12.0	Phenol/ Acetone	<ul style="list-style-type: none"> Cumene oxidation Fugitive emission 	Phenol, Acetone, Cumene, CO/CO ₂
13.0	Butanol / 2-Ethyl Hexanol	<ul style="list-style-type: none"> Oxides of carbon, nitrogen oxides & sulphur oxides 	n-Butanol, 2-Ethyl hexanol, sec-Butanol

S. No.	Name of chemical / product	Type of Emissions	Pollutants expected
		<p>from incineration of process waste gases & plant ejector vents.</p> <ul style="list-style-type: none"> • N-Butanol & mixed HC's from plant ejector vents 	
14.0	Cyclohexane	<ul style="list-style-type: none"> • Fugitive emission from pumps, valves, compressors & storages. Vent releases during shutdown 	Benzene
15.0	Maleic Anhydride	<ul style="list-style-type: none"> • Product recovery absorber vent containing benzene, maleic acid, acetic acid, carbon mono oxide etc • Vacuum system vent • Storage & handling emissions 	Benzene, Maleic Acid, Acetic acid, carbon monoxide
16.0	Phthalic anhydride	<ul style="list-style-type: none"> • Off gas from switch condenser / scrubber containing phthalic anhydride, maleic anhydride, various acids, & CO • Combustion products from incineration residue & overheads from distillation columns • Fugitive emissions from pumps, valves, storages etc. 	Xylene, Phthalic acid, Maleic acid, CO, CO ₂
17.0	TDI	<ul style="list-style-type: none"> • Phosgene from vent scrubber / incinerator • Fugitive emission from valves, pumps, compressors etc. • TDA vacuum distillation vent • TDI flash distillation 	Phosgene, TDI, HCl
18.0	PTA	<ul style="list-style-type: none"> • Off gases from oxidation stage containing CO, CH₃COOH, p-Xylene, 	p-Xylene, Acetic acid, Methyl acetate, CH ₃ Br, CO

S. No.	Name of chemical / product	Type of Emissions	Pollutants expected
		<p>CH₃Br, Methyl acetate</p> <ul style="list-style-type: none"> • Vent from solvent recovery containing CO, p-Xylene, Acetic acid, Methyl acetate • Vent from atmospheric absorber containing CH₃COOH & Methyl acetate • Vent from purification plant scrubber with Acetic acid & PTA • Vent gases from off-gas dryers containing Methyl acetate, Acetic acid and p-Xylene 	
19.0	DMT	<ul style="list-style-type: none"> • Off gases from oxidation stage containing Methanol, p-Xylene, CO etc • Absorber vent containing Methanol • Fugitive emissions from storage, pumps, valves, compressors etc 	Methanol, p-Xylene, CO
20.0	Nylon	<ul style="list-style-type: none"> • Vents from feedstock vessels 	Hydrocarbons
21.0	PVC	<ul style="list-style-type: none"> • VCM from reactors, monomer recovery & PVC stripping & drying • PVC particulate matter from transfer & storage • VCM from waste water collection & treatment 	Vinyl chloride
22.0	PE	<ul style="list-style-type: none"> • Purges of feed stocks or solvents or the products or their combustion • HC from raw material storage, degasser hoppers • Fugitive losses of feed 	Ethylene

S. No.	Name of chemical / product	Type of Emissions	Pollutants expected
		stock & solvent HC <ul style="list-style-type: none"> • Vents from catalyst preparation systems possibly with organometals • Vents at high pressure (LDPE) 	
23.0	PP	<ul style="list-style-type: none"> • Propylene particulate matter from vents (on dust extraction, extruder, extruder extract) • Propylene / propane from powder vessel vent • VOC's from extruded extract vent • Polymer dust from granulate transport air 	Propylene
24.0	Poly Styrene	<ul style="list-style-type: none"> • Fugitive emissions of Styrene, Toluene, Ethyl benzene • Particulate matter from product drying and handling 	Styrene, Toluene, Ethyl benzene
24.1	Expanded Poly Styrene	<ul style="list-style-type: none"> • Pentane & Styrene from storage • Pentane from filling & opening reactors & buffer vessel • Styrene during polymerization in the reactor • Pentane from driers & product hoppers • Particulate matter from product drying & handling 	Pentane, Styrene

Table 5.2: Categorisation of Volatile Organic Compounds

Substance	CAS No.	Acute Toxicity			Long Term Toxicity			TLV	POCP	ODP	GWP	Category	Basis
		LD ₅₀ Oral	LD ₅₀ Dermal	LC ₅₀ (inhl)	Carcino Group	Muta genicity	Terato genicity						
		mg/Kg	mg/Kg	mg/l				ppm	Value	Value	Value		
Ethylene	74-85-1	-	-	950000		-	-	-	100	-	-	Medium	POCP
Propylene	115-07-1	-	-	-	-	-	-	-	108	-	-	Medium	POCP
1,3 Butadiene	106-99-0	-	-	285 g/m ³	2A	C	E	10	-	-	-	High	Carcino /TLV
Benzene	71-43-2	3400	0.99	9980 ppm	1	C	E	0.1 (s)	33	-	-	High	Carcino/ TLV
Toluene	108-88-3	5000	1.120	4000 ppm	3	-	E	50 (s)	77	-	-	High	Toxicity
m-Xylene	108-38-3	-	1739	8000 ppm	3	-	E	100	109	-	-	Medium	POCP
o-Xylene	95-47-6	-	1364	-	-	-	E	100	83	-	-	Medium	POCP
p-Xylene	106-42-3	-	2110	4550 ppm	-	-	E	100	95	-	-	Medium	POCP
Methanol	67-56-1	5628	1826	64000 ppm	-	-	E	200	21	-	-	Low	-
Ethylene Oxide	75-21-8	72	175	800	2A	C	E	1	-	-	-	High	Carcino /TLV
Ethylene Glycol	107-21-1	1650	2800	-	-	C	E	50 [©]	-	-	-	Low	-
Vinyl Acetate	108-05-4	1613	2335	1550	3	-	-	10	-	-	-	Low	-
Ethylene dichloride	107-06-2	489	-	-	2B	-	E	10	-	-	-	Medium	Carcino /TLV
Vinyl Chloride	75-01-4	500	-	299 mg/m ³	1	-	E	5	27	-	-	High	Carcino
Propylene Oxide	75-56-9	520	364	1740	2A	-	-	20	-	-	-	High	Carcino
Propylene Glycol	57-55-6	19000	6660	-	-	-	E	-	-	-	-	Low	-
Acrylonitrile	107-13-1	27	35	258 (*)	2A	C	E	2(s)	-	-	-	High	Carcino /TLV
Isopropanol	67-63-0	3600	667	-	3	E	E	400	22	-	-	Low	-
n-Butanol	71-36-3	790	1072	8000 ppm	-	C	E	50 [©]	66	-	-	Medium	TLV
sec-Butanol	78-92-2	6480	277	-	-	C	-	100	-	-	-	Low	-
Acetone	67-64-1	3000	-	16000ppm (*)	-	-	-	750	18	-	-	Low	-
2-Ethyl hexanol	104-76-7	1180	500	-	-	E	-	-	-	-	-	Low	-
Cyclo- hexane	110-82-7	813	-	-	-	E	-	300	60	-	-	Low	-
Capro- lactum	105-60-2	1370	650	-	4	-	-	0.05	-	-	-	High	TLV

Substance	CAS No.	Acute Toxicity			Long Term Toxicity			TLV	POCP	ODP	GWP	Category	Basis
		LD ₅₀ Oral	LD ₅₀ Dermal	LC ₅₀ (inhl)	Carcino Group	Muta genicity	Terato genicity						
		mg/Kg	mg/Kg	mg/l									
Maleic Anhydride	108-31-6	390	97	-	-	E	-	0.25	-	-	-	High	TLV
Phenol	108-95-2	80	344	-	3	E	-	5(s)	-	-	-	Medium	TLV
TDI	584-84-9	5800	-	10ppm	2B	E	-	0.005	-	-	-	High	Carcino/TLV
Tere-phthalic Acid	100-21-0	18800	1430	-	-	-	-	-	-	-	-	Low	-
Phthalic Anhydride	85-44-9	2000	-	-	-	-	-	1 [©]	-	-	-	High	TLV
Dimethyl Tere-phthalate	120-61-6	4390	3900	-	-	-	-	-	-	-	-	Low	-
Acetylene	74-86-2	-	-	-	-	-	-	-	28	-	-	Low	-
2-Butene	624-64-6	-	--	-	-	-	-	-	99	-	-	Medium	POCP
1-Butylene	106-98-9	-	-	-	-	-	-	-	113	-	-	Medium	POCP
Carbon tetra chloride	56-23-5	2800	572	8000ppm	3	E	-	5(s)	-	1.2	1400	High	ODP/GWP/TLV
Chloroform	67-66-3	36	704	8000ppm	3	E	-	10	-	-	6	Medium	TLV
Ethyl chloride	75-00-3	-	-	-	-	-	-	1000	-	-	-	Low	-
Perchloro ethylene	127-18-4	8100	2100	5200ppm	2B	E	E	25	4	-	-	Medium	Carcino/TLV
Trichloro ethylene	79-01-6	2402	1900	8450ppm	-	-	-	-	-	-	-	Low	-
Acetaldehyde	75-07-0	1930	560	1500ppm	3	E	E	25 [©]	65	-	-	Medium	TLV
Acetic acid	64-19-7	3310	1060	16000ppm (*)	-	-	-	10	16	-	-	Medium	TLV
Epichloro Hydrin	106-89-8	90	118	250ppm (8hr)	2A	E	-	2(s)	-	-	-	High	Carcino / TLV
Hydrogen cyanide	74-90-8	3.7	1.57	323ppm	-	-	-	4.7(s)	-	-	-	High	TLV/ Toxicity
Ethyl benzene	100-41-4	3500	2272	4000ppm	-	-	E	100	-	-	-	Low	-
Acetophenone	98-86-2	815	200	-	-	-	-	10	-	-	-	Medium	TLV
Methyl ethyl ketone	78-93-3	2737	616	2000ppm	-	-	E	200	61	-	-	Low	-

Substance	CAS No.	Acute Toxicity			Long Term Toxicity			TLV	POCP	ODP	GWP	Category	Basis
		LD ₅₀ Oral	LD ₅₀ Dermal	LC ₅₀ (inhl)	Carcino Group	Muta genicity	Terato genicity						
		mg/Kg	mg/Kg	mg/l				ppm	Value	Value	Value		
Phthalic acid	88-99-3	7900	550	-	-	-	-	-	-	-	-	Low	-
Maleic acid	110-16-7	708	1560	-	-	-	-	-	-	-	-	Low	-
Phosgene	75-44-5	-	-	3200mg/m 3	-	-	-	0.1	-	-	-	High	TLV
Methyl acetate	79-20-9	3705	-	-	-	-	-	200	5	-	-	Low	-
Methyl bromide	74-83-9	214	-	302/8 hr	3	-	-	5(s)	-	0.64	-	Medium	TLV
Styrene	100-42-5	316	660	24000 mg/m3	2B	E	-	50(s)	8	-	-	Medium	Carcino
Pentane	109-66-0	-	-	-	-	-	-	600	62	-	-	Low	-

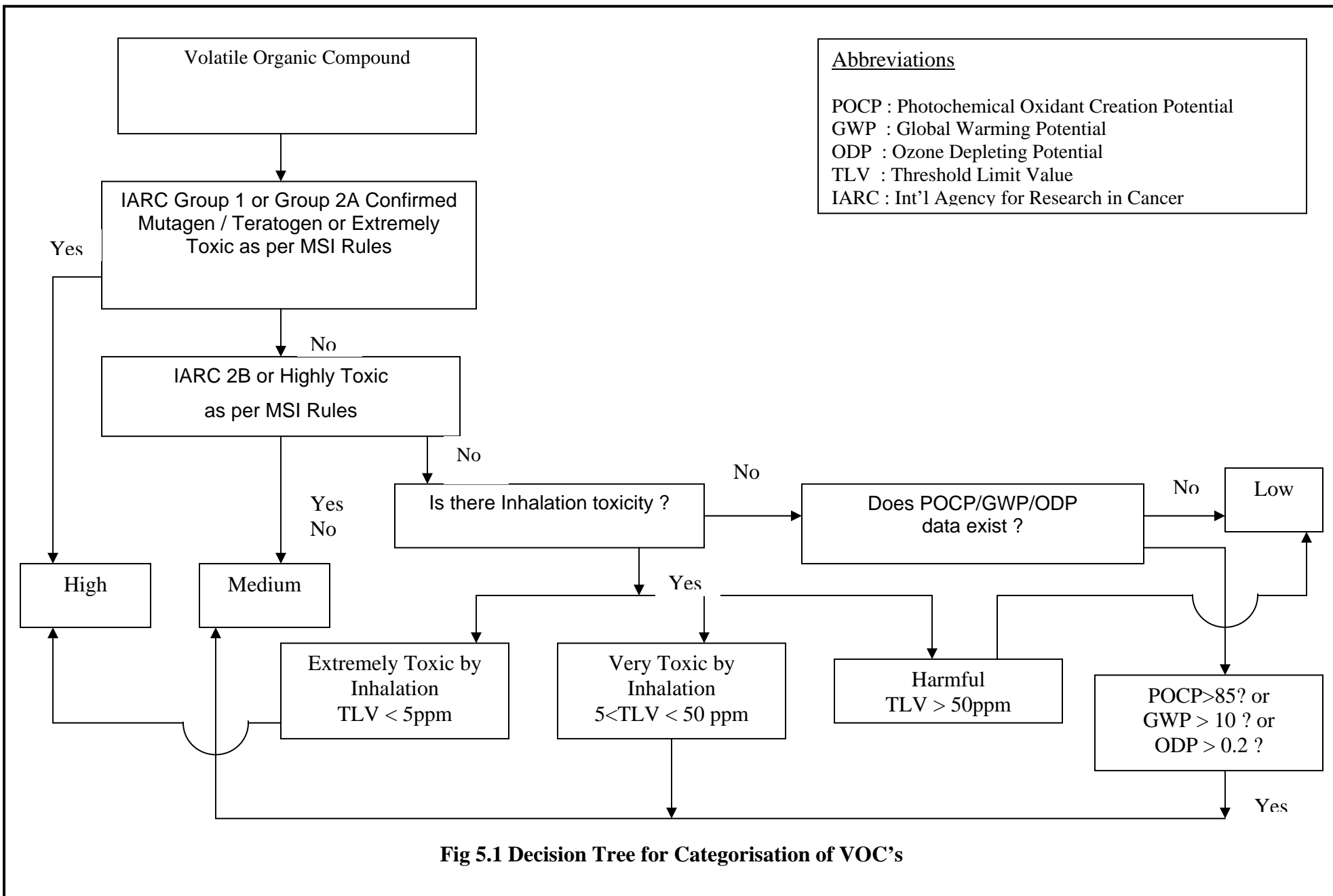

Fig 5.1 Decision Tree for Categorisation of VOC's

CHAPTER 6.0

EMISSION CONTROL TECHNOLOGIES IN PETROCHEMICAL INDUSTRIES

This chapter presents an overview of emission control technologies in practice, its application and the performance, i.e. the possible reduction that can be achieved. As seen in Chapter 4.0, emissions of VOC's /organic HAP's may occur from multiple sources but the following are the major sources:

- Process Vents
- Storage Vessels and Transfer operations
- Components (Fugitive emissions)

Various types of control technologies used for treatment of VOC/HAP emissions are:

- Combustion Devices (Incinerators/Flares/Heaters)
- Recovery/Recapture Devices (Condensers / Adsorbers etc.)
- Specific techniques for transfer racks/storage emissions

Combustion is the most universally applicable technique for control of organic HAP and VOC emissions. Properly designed combustion devices can achieve efficiencies of 98 percent reduction in organic HAP or VOC emissions.

Recovery and recapture devices employ same types of unit operations viz. adsorption, absorption, condensation etc. However, they differ in the end use of the recovered material for example the recovered material from recovery type of devices are used / reused or sold whereas materials from recapture devices are primarily disposed off.

6.1 Combustion Control Devices

Combustion control devices include incinerators, flares, boilers, and process heaters. Combustion control devices operate on the principle that any VOC heated to a high enough temperature in the presence of sufficient oxygen will oxidize to carbon dioxide and water. The theoretical combustion temperature varies due to different VOC's are oxidised at different temperatures, depending on their properties. A consistent VOC destruction efficiency can usually be achieved in combustion devices regardless of the amount and type of VOC in the vent stream. Scrubbers can be used downstream of combustion control devices (other than flares) to treat halogenated streams. Scrubbers reduce emission of halogens and hydrogen halides, such as chlorine and hydrogen chloride, formed during combustion.

6.1.1 Thermal incinerators

Thermal incinerators are usually refractory-lined chambers containing a burner (or set of burners). An efficient thermal incinerator provides (i) high temperature inside the chamber enough to completely oxidize the VOC's (ii) proper turbulence of combustion products, air, and the process vent streams, and (iii) adequate residence time to allow for complete oxidation of VOC's. **Fig. 6.1** shows the premixing chamber and combustion chamber of a discrete burner thermal incinerator. As shown in the figure, heat can be recovered to preheat combustion air or the process vent stream, or to generate steam. All thermal incinerators operate using excess air to ensure a sufficient supply of oxygen.

Thermal incinerators can achieve at least 98 percent destruction for most VOC's, for example vent streams with VOC concentrations below 1,000 ppmv, all new thermal incinerators can achieve outlet concentration of 20 ppmv or lower. Thermal incinerators are technically feasible control options for most vent streams. Excessive fluctuations in flow rate may prevent the use of a thermal incinerator in such situations a flare could be used.

6.1.2 Catalytic incinerators

Catalytic incinerators operate at lower temperatures than thermal incinerators because some VOC's are oxidized at lower temperatures in the presence of a catalyst. A schematic of a catalytic incinerator is shown in Fig. 6.2. The vent stream is preheated in a mixing chamber, and oxidation takes place on a catalyst bed like. Like the thermal incinerators, heat can be recovered from the exiting gas stream.

Catalytic incinerators can achieve overall VOC destruction efficiencies of 95 to over 98 percent. The efficiency depends on temperature, oxygen content, catalyst activity, and the characteristics and concentration of the VOC. Catalytic incinerators are typically used for vent streams with stable flow rates and stable concentrations. They cannot be used on vent streams that poison or block the catalyst reactive sites, or on vent streams with high inlet concentrations or flow rates.

6.1.3 Industrial boilers and process heaters

Industrial boilers and process heaters combust VOC's by incorporating the vent stream into the inlet fuel or by feeding the vent stream into the boiler or heater through a separate burner. Industrial boilers are used to produce steam. When boiler fire natural gas, forced-or natural-draft burners mix the incoming fuel and combustion air. A VOC-containing vent stream can be added to this mixture or it can be fed into boiler through a separate burner. The majority of industrial boilers used in the chemical industry are of water tube design, where hot combustion gases contact the outside of heat transfer tubes, which contain hot water and steam. Process heaters are used to raise the temperature of process streams using a similar tube design, where the process fluids are contained in the tubes. Heat recovery from the exiting gas stream is achievable for both industrial boilers and process heaters.

Boilers and process heaters can achieve efficiencies of at least 98 percent. They can be used to reduce VOC emissions from any vent streams that will not reduce the performance or reliability of the boiler or process heater. For example, the varying flow rate and organic content of some vent streams can lead to explosive mixtures or flame instability. Boilers and process heaters are most applicable where the potential exists for heat recovery from the combustion of the vent stream. Vent stream with a high VOC concentration and high flow rate can provide enough equivalent heat value to act as a substitute for fuel. Because boilers and process heaters cannot tolerate wide fluctuations in the fuel supply, they are not widely used to reduce VOC emission from batch operations and other non-contiguous vent streams. Vent streams with sulphur or halogenated compounds are not usually combusted in boilers or process heaters because these streams are corrosive.

6.1.4 Flares

Flaring is an open combustion process in which the oxygen necessary for combustion is provided by the air around the flame. High combustion efficiency in a flare is governed by flame temperature, residence time of the organic compound in the combustion zone, turbulent mixing to complete the oxidation reaction, and the amount of available oxygen. Steam-assisted elevated

flares are the most common type used in the chemical industry **Fig. 6.3**. The high flow rate of the vent stream into the flare requires more combustion air than diffusion of the surrounding air to the flame can supply. Steam injection nozzles are added to increase gas turbulence.

Flares can achieve 98 percent destruction efficiencies. Flares are most applicable to vent streams with wide flammability limits, low auto-ignition temperatures, and high heat contents. Flares can be designed to control both normal process releases and emergency upsets. Flares can be used to control almost any VOC stream and can handle fluctuations in VOC concentration, flow rate, heat content, moisture content, and inert content. Flaring is appropriate for continuous, batch, and variable flow vent streams. However, halogenated or sulphur-containing vent streams are usually not flared because they can corrode the flare tip or cause the formation of acid gases or sulphur dioxide. The EPA provisions do not allow vent streams above a specified halogen content to be routed to a flare.

6.1.5 Halogenated streams

Combustion equipment used for control of halogenated streams is usually followed by additional control equipment to remove corrosive combustion products (acid gases). The flue gas temperature is lowered, and the flue gas is then routed to a halogen reduction device such as a packed tower or liquid jet scrubber.

6.2 Product Recovery And Recapture Devices

Product recovery devices and recapture devices include absorbers, carbon absorbers, and condensers, and the specific device used is determined by the vent stream characteristics. These characteristics affect the performance of recovery or recapture device; therefore no single technology is applicable to all vent streams.

6.2.1 Condensers

Condensation is a separation technique in which one or more volatile components are separated from a vapour mixture through saturation followed by a phase change. Condensation can be achieved by lowering the temperature at a constant pressure, and refrigeration can be used to obtain the lower temperatures needed for compounds with lower boiling points.

Surface condensers and direct contact condensers are the two most commonly used types. In surface condensers, heat transfer occurs through tubes or plates in the condenser. Thus, the coolant fluid does not contact the vent stream, which allows for reuse of the coolant fluid. Furthermore, the VOC's can be directly recovered from the gas stream. A shell-and-tube condenser, which circulates the coolant fluid on the tube side, is shown in **Fig. 6.4**. Direct contact condensers spray the coolant directly into the vent stream. Therefore, the coolant cannot be reused directly and VOC's cannot be recovered without further processing.

Condensers may be used to recover raw materials and/or products. The removal efficiencies of condensers range from 50 to 95 percent, and the efficiency is dependent upon the vent stream flow rate, concentration, temperature, moisture content, and physical properties. Condensers are more economically feasible for streams with higher condensation temperatures. Vent streams with high concentrations of non-condensable will require a condenser with a larger surface area.

6.2.2 Adsorption

Adsorption is a mass-transfer operation where the gas-phase (adsorbate) is captured on the solid-phase (adsorbent) by physical or chemical means. A physically adsorbed molecule is easily removed from the adsorbent, whereas, the removal of chemisorbed molecule is difficult to achieve.

The most common industrial adsorption systems use activated carbon as the adsorbent. Activated carbon captures organic vapours by physical adsorption. Since oxygenated adsorbents selectively capture water vapours, they are not suitable for high-moisture process vent streams. Activated carbon beds are regenerated with steam or nitrogen, which release the captured vapours. **Fig. 6.5** show a typical fixed-bed, regenerative carbon adsorption system. When one bed is saturated, the vent stream is routed to an alternate bed while the saturated carbon bed is regenerated. The steam-laden vapours from regeneration are sent to a condenser and then to a VOC recovery system to separate the VOC's from the condensed steam.

Continuous VOC removal efficiencies of more than 95 percent are achievable using adsorption. The VOC removal efficiency of an adsorption unit depends on the vent stream characteristics, the physical properties of the compounds in the vent stream and of the adsorbent, and the condition of the bed. Carbon adsorption is not recommended for vent streams with high VOC concentrations, high or low molecular weight compounds, mixtures of high and low boiling VOC's, or vent streams with high moisture content.

6.2.3 Absorption

Absorption is the selective transfer of one or more components of a gas mixture (solute) into a liquid solvent. Devices based on absorption principles include spray towers, venturi and wet impingement scrubbers, packed columns, and plate columns. Spray towers have the least effective mass transfer capability and are generally restricted to particulate matter removal and control of high-solubility gases. Venturi scrubbers are also limited to particulate matter and high-solubility gases. Therefore, VOC control by gas absorption is limited to packed or plate columns. A counter current packed column is shown in **Fig. 6.6**.

Control efficiencies for absorbers vary from 50 to greater than 95 percent. Efficiency depends on the selected solvent, the contact surface area (absorber size), and the temperature. The applicability of absorption to vent streams is dependant on the availability of a suitable solvent, and the solubility of the VOC in the solvent. If a VOC cannot be easily desorbed from the solvent, then absorption is less viable. Absorption is usually considered for streams with a VOC concentration above 200 to 300 ppmv.

Scrubbers are used downstream of combustion devices to control emission of halogens and halogen halides formed during combustion. The typical scrubbing solvents used are water or a caustic solution. Either plate or packed bed scrubbers can be used, and these scrubbers can have counter current or crosscurrent flow. The type and orientation of the scrubber used depends on liquid and gas flow rates.

Scrubber efficiencies for removal of halogens and halogen halides will vary depending on the type of scrubber and the type of solvent used and the equilibrium relationship between the gas and liquid. However, most systems can achieve efficiencies from 90 percent to greater than 99 percent.

The different type of technologies and its achievable value are summarized below.

S. No.	Technology	Achievable value	Remarks
1	Condensation	Condensation: 50 – 98% recovery + additional treatment	Indicative application range: flow 100 - 100000 m ³ /hr ,50 – 100 g VOC /m ³ in feed
		Cryo condensation: 95 – 99.95% recovery	Flow: 10 – 1000 m ³ /hr, 200 – 1000g VOC/m ³ 20 m bar – 6 bar
2	Absorption	95 – 99.95% recovery	Indicative application range for regenerative adsorption: flow: 100 – 100000 m ³ /h
			0.01 – 10 g VOC/m ³ , 1-30 atm pressure
			Non regenerative adsorption
			Flow: 10 - 1000 m ³ /hr 0.01 – 1.2 g VOC/m ³
3	Scrubber	95 – 99.95% reduction	Indicative application range
			Flow: 10 – 50000 m ³ /hr, 0.3 - 5 g VOC/m ³
4	Selective membrane separation	95 – 99.95% recovery VOC < 20 mg/m ³	Indicative application range: 1 - 10 g VOC/m ³ , efficiency may be adversely affected by gas closed to its dew point.
5	Flare	Elevated flare > 99% Ground flares > 99.5%	Can accommodate large flow and wide characteristics. Proper design is important.
6	Thermal incineration	95 – 99.95% reduction VOC (2) < 1 – 20 mg/m ³	Indicative application range: Flow: 1000 – 100000 m ³ /h, 0.2 - 10 g VOC/m ³ range of 1 – 20 mg/m ³ is based on emission limit and measured values. The reduction efficiency of regenerative or recuperative thermal incinerators may be lower than 95-99% but can achieve < 20 mg/m ³ .
7	Catalytic oxidation	95 – 99.95% reduction VOC < 1 – 20 mg/m ³	Indicative application range: Flow: 10 – 100000 m ³ /h, 0.05 – 3g VOC/m ³

Note:

1. The technology can have impact on other phase (i.e. cross media issue) needs consideration.
2. Unless stated, concentrations relate to half hour or daily averages for reference conditions of dry exhaust at 0°C.

6.3 Control Techniques Specific to Transfer Operations

Organic HAP and VOC emission from tank and railcar transfer racks can be collected in a vapour collection system and routed to a control device. Unlike process vents, the "control device" for transfer racks includes recovery devices as well as combustion devices. **Fig 6.7** shows a tank

truck vapour return line routed to a vapour recovery device. Alternatively, transfer rack emission can be controlled by using a vapour balancing system or routing to a process or fuel gas system.

6.3.1 Vapour collection system

Vapour collection systems consist of piping or ductwork that captures and transports to a control device organic compounds from the vapour space of a transport vessel. Loading rack systems that incorporate the product and vapour lines into a single system are preferred since both connections can be conveniently moved out to the vessel simultaneously. The vapour return line can either be a flexible hose or a metal pipe incorporated into the loading rack arrangement using a dual style orientation. **Fig. 6.7** shows a tank truck with a vapour collection system (vapour return line), and **Fig. 6.8** illustrates a dual arm loading rack.

6.3.2 Vapour balancing

Vapour balancing is another means of collecting vapours and reducing emissions from transfer operations. Vapour balancing is most commonly used where storage facilities are adjacent to the loading facility. As shown in **Fig. 6.9** an additional line is connected from the transport vessel to the storage tank to return any vapour that is displaced from the transport vessel to the vapour space of the storage vessel from which the transferred liquid was pumped. Because this is a direct volumetric exchange, there should be no losses to the atmosphere.

6.3.3 Route to a process or fuel gas system

Emissions from transfer operations may be routed to a process or to a fuel gas system to comply with the transfer control requirements. Fuel gas systems supplies fuel to large boilers or process heaters that easily combust the HAP and VOC emissions from transfer operations. **Section 6.1.3** describes industrial boilers and process heaters.

6.4 Control Techniques Specific to Storage Vessel

The control techniques to reduce emissions from storage vessels include equipment designs (e.g., seal design and fittings closure) and work practices.

6.4.1 Fixed-roof vessel

Emission from a fixed-roof vessel may be reduced by equipping with either a floating roof (i.e. converting it to an IFR vessel) or by using a closed vent system routed to a control device.

A closed vent system capture the vapours released by the fixed roof vessel and transfer them to a product recovery or combustion control device. Refer to section 6.2 of this chapter for a description of product recovery and combustion control device. These same devices would be used to control the storage emissions.

A closed vent system and control device can also be applied to a horizontal tank. Because of the tank configuration, a floating roof cannot be applied to a horizontal tank.

6.4.2 Floating roof vessel

As discussed in chapter 4 the three types of floating roof vessels are IFR (Internal Floating Roof) vessels, EFR (External Floating Roof) vessels, and EFR vessels converted to IFR vessels.

There are three methods for controlling emissions from floating roof vessels, applying controls to deck fitting, employing certain types of seal, and employing certain work practices. Examples of these three methods are to equip the covers on certain deck fitting with gaskets, to equip an EFR or IFR with a liquid-mounted seal instead of a vapour-mounted seal, and to keep all covers associated with deck fitting closed at all times except for access.

Following are typical examples of deck fitting control for an EFR vessels: 1) roof must have a slotted membrane fabric cover that covers 90 percent of the area of the opening, 2) openings with covers must be bolted when closed, and 3) guide pole wells must have a sliding cover or flexible fabric sleeve seal and if the guide pole is slotted, a gasket float inside the guide pole.

For IFR vessels, the following are typical examples of controls: 1) ladder wells must have a gasketed sliding cover and 2) rim vents must be gasketed and closed except when the IFR is not floating on the stored liquid or when the pressure beneath the rim seal exceeds the manufacturer's recommended setting.

6.4.3 Route to a process or a fuel gas system

Similar to transfer operations, emissions from storage vessels may be routed to a process or to a fuel gas system. Fuel gas systems supply fuel to large boilers or process heaters that easily combust the HAP and VOC emissions from storage vessels. **Section 6.1.3** describes industrial boilers or process heaters.

6.5 Best Available Technology (BAT)

6.5.1 Best available techniques for air pollution reduction in cracker furnace

As observed, majority of emission from cracker complex are of the indirect type due to unplanned shutdowns, fugitive emissions and losses during maintenance. Hence this section presents air pollution control options for crackers starting from process selection to control of individual emission sources. In developing this section, the relevant process of Best Available Techniques (BAT) identified by European Union have also been presented alongwith control strategies.

Process Selection

The steam cracking process is the only large scale process currently available for production of the full range of lower olefins (ethylene, propylene and butadiene) and is generally BAT. There is no recommended BAT feedstock although emissions from plants using gas feedstock tend to be lower than from plants using naphtha or gas oil feedstock.

Plant design

By their nature, steam crackers are large plants utilising significant quantities of energy (15 to 50 GJ/t ethylene) to process highly flammable hydrocarbons at elevated pressures and temperatures. BAT for the design of steam crackers includes the following components :

BAT for Design of Steam Crackers

S. No.	Component / Technique	Achieve by
1	Design for high level of containment and minimizing fugitive emission	<ul style="list-style-type: none"> • Seal-less pumps / compressors / Agitators etc. particularly in HAP service • Low loss valve packing • Minimise use of flanges • Barrier fluid on double mechanical seal to degas to closed vent / control device or process gas as barrier fluid
2	No hydrocarbons vents to atmosphere for normal operation	<ul style="list-style-type: none"> • Cap /blank vents / drains provided on vessels (for equipment maintenance)
3	Dispose off-spec / purge streams through flare collection systems	<ul style="list-style-type: none"> • Minimise need for flaring by selecting appropriate pressure rating of equipments • Design for smokeless operation to the maximum
4	Highly integrated energy systems to reduce hydrocarbon losses	<ul style="list-style-type: none"> • Use advanced pinch analysis to aid energy integration and recover energy
5	Minimise shut down frequency even up to 5 years between planned overhauls	<ul style="list-style-type: none"> • Hold sufficient spare part inventory • Have on-line equipment condition monitoring • Have proper I and M programs • Have proper operating strategies
6	Provide extensive automatic systems for safe shutdowns of plants	<ul style="list-style-type: none"> • Systems to be fully redundant • Capable of on-line proof testing • Backed up against power failure
7	Minimise waste at source	<ul style="list-style-type: none"> • Recycling and reprocessing streams within the plant e.g. inventories of equipment taken-up for maintenance or recovery of off-specification products
8	Segregated and closed effluent collection system	<ul style="list-style-type: none"> • Use corrosion resistant material and closed drains to avoid VOC emissions
9	Reduce emissions from storage	<ul style="list-style-type: none"> • Connect day tanks at atmospheric pressure to control system / flare (e.g naphtha / gasoline) • Tanks for aromatic rich streams-use IFR/EFR tanks or vent to control system/recovery device / flare or tanks should vapour balance • Provide vent filter of activated carbon on nitrogen blanketed tanks to reduce VOC emissions
10	Reduce emissions during sampling	<ul style="list-style-type: none"> • Provide closed, on-line automated sampling techniques • For manual sampling provide closed loop sampling with quick connection / disconnection couplings.

Control of Emission from Cracker Furnaces and Steam Superheaters

(a) Nitrogen Oxides

Conventional burners firing natural gas usually produce 250 mg/Nm³ of NO_x. Low NO_x burners (LNB) are being provided by number of vendors which may reduce the NO_x levels further (100 – 130 mg/Nm³). Ultra low NO_x burners (ULNB) are claimed to achieve 75 – 100 mg/Nm³ NO_x. LNB and ULNB use staged air or fuel addition to reduce the residence time and peak temperature in the burner, thus reducing NO_x. DeNO_x units employ catalysts and ammonia to reduce the NO_x emissions to Nitrogen and moisture (NO_x 60–80 mg/Nm³). Platinum containing monolithic catalysts are used and generally perform well at temperatures of around 400°C. Careful control of ammonia quantity is required otherwise a ammonia source is created. Also bed temperature needs to be controlled carefully, as below optimum temperature, catalyst activity reduces allowing ammonia slippage and at temperature above 450°C, ammonia itself gets oxidised to NO_x. State-of-the art cracking furnaces with selective catalytical reduction (SCR) have been designed to achieve NO_x of 60-80 mg/Nm³. However, over the operating cycle of a furnace, there is evidence to indicate a deterioration of performance of SCR units, leading to higher NO_x levels and NH₃ slippage. Overall performance of DeNO_x and ULNB system is very much similar.

BAT for control of NO_x emissions for new installation is therefore :

- Use of Ultra low NO_x burners (ULNBs) to reduce emissions to upto 75 mg NO_x/m³ (as NO₂) or alternately
- Use of Catalytic De NO_x (Selective Catalyst Reduction) system to reduce emissions to upto 60 mg/m³ (NO₂)

For existing plants BAT decision will depend upon feasibility of installing LNBs, ULNBs or SCR considering plant design and layout.

Catalytic de NO_x may give rise to ammonia emission. BAT associated ammonia levels (as an hourly average) are <5 mg/m³ at high NO_x reduction rates (> 80%) in new installations.

(b) Carbon Monoxide

Advanced combustion control systems are deployed in modern crackers to keep CO levels to less than 20 mg/m³. Excess Oxygen is then maintained to only 2-3 % in the stack.

BAT for carbon monoxide emission is the use of advanced combustion control device utilising feed back from continuous flue gas analysers. BAT for gas fired cracking furnaces and steam superheaters also calls for modern firebox design with extensive energy recovery facilities giving a thermal efficiency of 92-95% in order to control CO/CO₂ emissions.

Decoking Vent Gas :

As is seen, decoking vent gas is a source of CO/CO₂ and Total Particulate matter (TPM) emissions. The vent gas maybe discharged to :

- A common decoke drum to serve a number of furnaces, equipped with wet dedusting (water spray tower, water scrubber) or dry dedusting (cyclones, bag filters) or
- Individual decoke drums for each furnace, as above
- Provision to route decoking air/steam mix into furnace firebox (with adequate residence time to ensure complete combustion of the coke particles)

Because , furnaces are in decoking mode for only 3% of the time, the use of elaborate dedusting systems are not appropriate, BAT is to minimise the coke formation through process optimisation and use of dry cyclones or wet scrubbing systems to abate emissions. Alternately recycle of effluent stream to furnace fire box to completely burn the coke particles is also acceptable. A particulate content of < 50 mg/Nm³ (as hourly average) can be achieved.

Flaring

Any loss of hydrocarbon to flare represents potential value loss to the operator. Considerable steps are therefore taken to minimise flaring both through equipment design and reliability and through the use of high-integrity emergency shutdown systems, to avoid the need to divert material to flare. Minimising emissions from flares therefore covers two main aspects :

- a) Minimising unburned hydrocarbons, smoke and where possible minimising noise, through
 - The use of smokeless flare design
 - The use of steam injection to assist air / hydrocarbon mixing (this may be automatically ratio controlled to the quantity of hydrocarbons being flared)
 - The use of video or IR monitoring of flare tip (often with time-lapse recording to allow post-event analysis).

Elevated flares are typically capable of smokeless operation up to around one-third of maximum rated capacity. The steam supply needed to sustain this performance should be sourced from a secure location, such as a utility centre within the plant complex.

- b) Minimising the quantity flared, through :
 - Sound engineering design, with high equipment reliability (including, for example, design for containment of refrigeration inventories in the event of a compressor trip)
 - Use of well trained technicians and engineers with regular competency monitoring

- Application of recognised maintenance management and condition monitoring programmes to assure high levels of equipment availability (e.g. on-line condition monitoring for major compressors)
- Use of high integrity trip systems to reduce the possibility of spurious trips and minimise the impact of genuine failure
- Use of flare gas recovery systems to recycle flare gas to the process or fuel systems (usually only possible for small quantities of material).

As reported earlier, there is a need for flaring during cracker start-up. The start-up period may vary between 15 hours to a few days and may produce upto 60 tonne per hour (TPH) of gas requiring flaring. Plant design has evolved to minimise the requirement to flare on start-up, by initially running the fractionation stages on pure ethylene and then gradually introducing furnace off-gases. This has the advantages of much reduced exhaust gas volumes. At new plants the additional investment costs of flareless start-up are very low and existing plants can be retrofitted with acceptable costs. However, flareless start-up is not a standalone piece of technology that can be purchased and applied to all plants.

It involves use of several internal recycle loops to allow various stream to be returned to the furnace area or fuel systems while the intermediate stream components are equilibrating. Thus it needs large storage facilities (of ethylene, propylene, raw C₄ and off specification product) and integration of plant with a fuel gas network. The flexibility to operate fractionation equipment on recycle depends greatly on the existing plant design. The technical feasibility of implementation in existing plants therefore requires case-by-case consideration.

Point Source Emission

In modern plants all possible vents from the process are collected in a closed system and routed to a suitable purge gas system. However, in limited instances, even the very small back-pressure imposed by the purge gas system cannot be tolerated and vents may need to be routed to atmosphere for safety reasons. Direct hydrocarbon vents to atmosphere should be avoided as far as practicable but where this is not possible VOC emissions may be reduced by such techniques as knock-out drums (to recover hydrocarbons), activated carbon adsorption or scrubbing. BAT is the collection of point sources to a suitable purge system for recovery into fuel gas or to flare.

Sour Gas Disposal

The acid gases (H₂S/CO₂) are removed in the process by scrubbing with caustic preceded by an amine wash. Spent caustic effluent containing sodium carbonate / bicarbonate and sodium sulfide when neutralised (acidified) will result in a gas stream containing H₂S. Spent caustic thus needs to be oxidised (typically in a wet air oxidation process) or stripped to a closed system. Wet air oxidation produces a waste water containing sulphates and an air stream that has to be treated in an afterburner to destroy the hydrocarbons in it. Alternately, H₂S generated in the acidification / neutralisation needs to be either burnt to SO₂ or converted to sulphur.

Selection of treatment route is heavily dependant on local conditions and BAT can be :

- Recovery for direct sale, or
- Treatment in wet air oxidations unit, or
- Acidification to allow sulfur recovery (in a claus unit), or
- Acidification prior to incineration, or
- Disposal via a sour flare system
-

6.5.1.1 Emission control technology for existing cracker units in India

The problems of existing cracker units can be put as below :

- High NO_x from cracking furnaces (especially old plants)
- High hydrocarbon losses (as seen from material balance)
- Flaring systems inadequacies

The likely strategies for emission control should be as given below:

NO_x control: Existing units should be asked to switch over to low NO_x burners to reduce NO_x levels to about half of current levels.

Reduction of Hydrocarbon losses: Cracker plant involves handling of high volumes of hydrocarbons at severe conditions of temperatures and pressures. This indicates the need for strengthening the environment management system to have:

- Reduced losses from components
- LDAR to monitor / repair leaking equipment
- Review operational procedures (e.g. equipment depressurising) which may lead to hydrocarbon losses
- Review instrumental facilities
- Review training inadequacies (of maintenance and operational staff)

Flaring system inadequacies: Large quantities of hydrocarbons were flared in a month. It was seen that flaring is essential for cracker operations and higher quantities are due to higher numbers of trips / plant failures. Thus, it is seen that management systems need to be strengthened to reduce hydrocarbons quantities going to flare. The measures can include

- Review failure causes to reduce spurious trips in future
- Have on-line integrity testing of critical equipments
- Review energy integration
- Review instrumental facilities and maintenance procedure / systems
- Review training inadequacies (of maintenance and operational staff)

It is seen that flares are smoky / noisy / luminous in many units in India. This requires for improvement of flaring systems by way of:

- Proper adjustment of steam flow rate by manual / automatic system (to reduce smoky flare)
- Providing acoustic shrouding / modifying steam nozzle design (for noisy flare)

- Proper adjustment of steam / air flow to reduce oxygen deficiency (for highly luminous flare)

6.5.2 Best available techniques for air pollution reduction for EO/EG

This section presents air pollution control options starting from process selection. In developing this section, the process specific BAT (Best Available Techniques) identified by European Union is also presented along with control strategies.

Process Selection

Ethylene oxide process

The direct oxidation of ethylene by pure oxygen is BAT for the production of EO due to the lower ethylene consumption and lower off-gas production. The conversion of an existing air-based unit to pure oxygen feed is a major modification involving a large investment cost and may not be BAT.

Ethylene glycol process

The process is based on the hydrolysis reaction of EO. BAT is to optimise the reaction conditions in order to maximize the production of valuable glycols while reducing the energy (essentially steam) consumption.

Plant Design

In addition to normal sources such as (control) valves, pumps and flanges the EO plant itself is a potential contributor to fugitive emissions since volatile organic hydrocarbons are present in relatively large quantities at elevated pressures. The VOC releases consist mainly of EO, ethylene, and methane (where methane is applied as diluents in the recycle gas loop).

Due to its toxic and carcinogenic nature, threshold limit values for EO in ambient air are very low (in the order of 1 ppm). For occupational health reasons and considering high flammability of EO extensive measures have to be taken by the industry to prevent EO releases, including fugitives, or to detect them at an early stage such that remedial measures can be taken promptly. The following are additional precautions:

- Careful material selection for seals, O-rings, gaskets, etc in EO duty
- Use of double seals or tandem seals on pumps in EO duty or use of canned or magnetic drive pumps
- Installation of sensitive EO detection systems for continuous monitoring of ambient air quality (these systems also detect ethylene)
- Application of metal strips around flanges with a vent pipe sticking out of the insulation that is monitored for EO release on a regular basis
- Monitoring of EO plant personnel for EO exposure (since exposure means emission)
- Reduce number of flanges as much as possible

BAT for fugitive emission is concomitant with minimising operator exposure to EO. This is demonstrated by observing threshold limits in ambient air of less than 1 ppm EO (1.8 mg/Nm³) for an 8-hours / day exposure.

Process Vents

BAT for vent streams from normal operation that contain organics is connection to a recovery system or to a vent gas treatment (e.g. fuel gas network, flare, scrubber) to achieve an emission of <5 mg EO/Nm³.

Almost all the organic air emissions from EO/EG plants can be prevented, re-used, recycled or combusted, in the following manners.

(i) Carbon dioxide vent

It is seen that the CO₂ purge has about 60% CO₂ and significant content of Ethylene, small quantities of Ethylene oxide and methane.

BAT for carbon dioxide vent is to minimise ethylene, Methane and CO₂ by:

- Reducing the formation of carbon dioxide through development of EO catalysts
- Selling the carbon dioxide as a commercial by-product (only where suitable outlets for the treated stream exists)

BAT for treatment of carbon dioxide vent can be by:

- Recovering ethylene and methane from the fat carbonate solution before stripping out the carbon dioxide. 'Flashers' can recover a significant amount of the absorbed ethylene and methane from the carbonate solution prior to carbon dioxide removal in the carbon dioxide stripper. The overheads of the flasher can be recycled back to the process
- Removing ethylene and methane from the carbon dioxide vent. Either thermal or catalytic oxidizers represent techniques for abatement of the ethylene and methane as they ensure an overall VOC destruction of roughly 98%. The vent stream after treatment is either routed to atmosphere or recovered for further use (the carbon dioxide customer may further purify the stream)

(ii) Inerts vent

A purge is taken from the recycle gas to reduce the build-up of inerts and this is vented to air after treatment. In the oxygen based process the inerts vent consists mainly of hydrocarbons (ethylene, methane etc.) and inerts (mainly nitrogen and argon impurities present in the ethylene and oxygen feedstock), but the exact type and content depend on the inert used.

BAT for treatment of inerts vent stream include:

- Route to fuel gas system use for energy generation, in boilers
- At facilities where there is energy excess and there is no outlet for energy re-use, then BAT for the inerts vent may be flaring. Under optimal conditions, fuel gas or flare systems can typically reduce EO emission levels to $< 1 \text{ mg EO/Nm}^3$ (as an hourly average).

(iii) VOC from scrubbing EO off gases

EO containing vent gases may originate from various sources in the process, such as: flashing steps in the EO recovery section, the EO purification section, process analysis, and safety valves. They may also originate from associated activities, such as EO storage or buffer vessels, and EO loading/unloading operations. Apart from EO, these vent gases typically contain non-condensable like argon, ethane, ethylene, methane, carbon dioxide, oxygen and/or nitrogen.

The BAT to minimise / treat the EO stream include

- Vent stream containing valuable components (ethylene, methane) in addition to EO are usually routed to a scrubber (operated at the lowest possible pressure so that all process vents can be routed to it). EO is recovered by absorption in water, and recycled back to the process. The scrubber overheads stream (comprising ethylene / methane) is compressed and also recycled back to the process, leaving no residual effluent stream or emission to atmosphere, as justified on a case-to-case basis.
- Some EO containing vent streams do not contain other valuable components (e.g. EO storage and EO loading/unloading operations consists mainly of nitrogen). Such streams are typically vented to atmosphere after treatment. The BAT-associated emission level (as an hourly average) from scrubbers is $< 5 \text{ mg EO/Nm}^3$. Techniques to minimise these streams include: providing pressure balancing lines between EO tanks, and installing vapour return systems during EO loading/unloading.
- If no vent compressor system is available to recycle the vents containing non-condensable hydrocarbons back to the process, such vents should be sent to a flare or incinerator.

Storage facility

As a safety precaution, ethylene and oxygen are usually stored outside battery limits of the EO/EG unit, and fed by pipe to the process unit. EO is typically stored in pressure vessels under a nitrogen blanket, which may also be refrigerated. The nitrogen serves as diluents in order to keep the vapour phase outside the explosive limits. Tank vents are typically routed to a water scrubber that ensures nearly

100% EO recovery. EG and heavier glycols are stored in atmospheric vessels since glycols have a lower vapour pressure and emissions to air are negligible.

EO loading facilities

Systems for loading EO into trucks or railcars are typically equipped with vapour return systems in order to minimise the release of vent streams containing EO. Alternatively, EO containing vent streams are subjected to an appropriate treatment technique, such as water scrubbing, in order to prevent EO emission to atmosphere. Emissions of EO during loading operations are minimised by properly purging relevant piping and coupling connections before decoupling. Purge vents are subsequently treated (typically by water scrubbing) in order to recover the EO.

The design and operation of EO storage/loading facilities are aimed at minimizing the risk of explosions or runaway reactions that could compromise EO containment and these same measures have major environmental benefits. An important area is avoiding the ingress of air, which could form an explosive vapour mixture with EO, or of other impurities that are reactive with EO or that could catalyse EO runaway reactions.

6.5.2.1 Emission control priorities for existing plants of EO/EG

Based on the above discussions, monitoring results, emission control priorities for existing plants are presented as under

- Re-absorber vent is seen to be discharged to atmosphere by one of the units. This has very high concentration of organics and needs to be treated by providing recycle gas compressor or diverting the same to flare.
- CO₂ purge – provide flasher or thermal oxidiser to reduce emissions to atmosphere. Monitor for both EO and TOC content (as other organic like ethylene and EG are also seen in high quantities)
- Provide residual EO absorber / vents EO absorber to take care of miscellaneous EO sources such as storage areas / tanker loading etc. Find other organics in vent and decide upon need to recycle tail gases from this absorber back to process if concentration is high
- Provide storages with Nitrogen blanketing and chilling to ensure containment
- Provide stringent controls for all components in EO service
- Develop operational practices / LDAR to reduce EO emissions

6.5.3 Best Available Techniques for Air Pollution Reduction for EDC and VCM

This section presents air pollution control options starting from process selection. In developing this section, the process specific BAT (Best Available Techniques) identified by European Union is also presented along with control strategies.

Process Selection

The BAT route for the production of EDC and VCM is via the chlorination of ethylene. BAT is the balanced process optimised so as to maximize the recycle of process streams.

In the ethylene oxychlorination step, there are choices between the source of oxidant (air or oxygen) and the reactor type (fixed or fluidised bed).

- Source of oxidant: The use of oxygen is considered to be BAT for new plants (probably because of lower losses of ethylene/EDC and lower off-gas volumes) provided that there is an economically available source of oxygen. For an air-based unit, the retrofitting of oxygen may be justified by site specific, economic reasons (e.g. An increase in production capacity, limited capacity of a site incinerator)
- Reactor type: Fixed bed and fluid bed reactors are both regarded as BAT

Plant Design

Reduction of chlorinated by-product formation

BAT for reduction of the chlorinated by-products is the use of such techniques as:

- Hydrogenation of the acetylene contaminant in HCl produced in the EDC cracking plant and recycling to oxychlorination. By effecting this hydrogenation it is possible to avoid the formation of dichloroethylenes, trichloroethylenes, tetrachloroethane and tetrachloroethylene. Without the trichloroethylene it is possible to carry out the distillation of the light ends, increasing in this way the EDC recovery.
- Complete recycle of the raw materials and reaction intermediates. The ethyl chloride can be separated from the lights and recycled to the oxychlorination section; the ethylene contained in the purge gas can be converted in EDC in specific reactors
- Use of burners with flat flame in the cracking furnaces. The use of these burners allows to reduce the hot spots on the walls of the process tubes and consequently the production of by-products due to the high temperatures.
- It is good technique to have stringent control on ethylene quality and EDC purity to ensure low by-products formation.

Heat Recovery from Cracking Furnaces

The recovery of the heat in the process gas leaving the cracking furnace could be used to vaporize the EDC feed to the furnace or to generate steam depending on the energy situation of the plant. The recovery allows reduction of prime energy consumption either by vapoursation of the cracker EDC feed or by production of steam to be used elsewhere in the process. Both alternatives reducing subsequently the total emission of CO₂ and NO_x from the production site.

Recovery

EDC and VCM maybe, recovered from some inert gas flows and recycled to the process. This has commercial and environmental benefits. BAT processes for the recovery of ethylene, EDC, VCM and other chlorinated organic compounds are:

- Recycling directly to the process
- Refrigeration and condensation
- Absorption in solvents followed by stripping; or
- Adsorption on solids followed by desorption

These techniques are BAT for the following sources (vents):

- Direct chlorination reactor
- Oxychlorination reactor
- Distillation columns and dryers for by-products including light-and heavy-ends
- VCM/EDC separation
- VCM purification
- Vacuum pumps
- Sampling systems
- Tanks and pipelines for EDC, VCM and by-products
- Contaminated wastewater collection and treatment system.

Treatment

Nearly all vents can be sent to air pollution control equipment, except for.

- Vents for gases during the transient periods where they contain explosive mixtures of organic compounds and oxygen
- Major relief vents, which due to their large flow will overload the treatment system.

After recovery options have been exhausted it is BAT to reduce the concentrations of chlorinated compounds and ethylene in off-gas efficient combustion techniques followed by energy recovery.

- **Thermal oxidation:** Most process and storage vents can be collected for combustion in a purpose built high temperature oxidation unit. This is BAT recommended method for VOC's in the thousands of ppm range. Recommended temperatures are more than 750°C with rapid quenching to reduce dioxin formation.
- **Catalytic oxidation:** Catalytic oxidation is restricted to low concentrations of organic compounds, as off-gas temperatures will otherwise be too high and inactivate the catalyst. The concentrations and temperatures are controlled in an effective range in which the desired degradation of VOCs is achieved. NOx are not generated in catalytic oxidation and the formation of PCDD/F is minimised. This is BAT recommended technique for VOC's in several hundreds of ppm range-catalytic (flameless) combustion at 500-600°C with little or no fuel gas consumption.

- **Hazardous waste incineration:** Incineration in a multi-purpose unit for liquid and solid wastes. Such units are likely to be covered by the Hazardous Waste Incineration Directive (94/67/EC), which sets limits for a wider range of substances and requires their continuous monitoring. The requirements of Directive 94/67/EC will be superseded by the requirements of Directive 2000/76/EC in December 2002, for new plants and in December 2005 for existing plants.

BAT is to combust all vents except those that pose unacceptable explosive risks and those with such large flows that they would overload the treatment system. An oxidiser may be followed by activated carbon if dioxin levels are high, BAT for the HCl formed from the combustion of chlorinated organic compounds is recovery by absorption either in water/hydrochloric acid (for recovery of HCl and re-use within the process), or in water/alkaline solution (for HCl emission reduction).

In combination, these techniques can achieve the concentrations shown in **Table 6.1**.

Table 6.1 Maximum emission levels in treated off-gas

Parameter	Maximum Emission Level
VCM	1 mg/Nm ³
EDC	
HCl (as total chloride ion)	10 mg/Nm ³
Chlorine	5 mg/Nm ³
Dioxin (I-TEQ)	0.1 mg/Nm ³

Note:

1. Maximum emission levels are average with no single measurement higher than twice the value (except the dioxin value which is an annual average)
2. Concentrations are adjusted to 213°K, 101.3 kPa, dry gas, 11% oxtgen by volume.

Emissions from Storages

The vents on atmospheric storage tanks for EDC and chlorinated by-products are stored under inert blanketing (e.g. nitrogen) and equipped with refrigerated reflux condensers or by connecting to gas recovery and/or a thermal or catalytic oxidizer. However, consideration must be given to safety considerations of retrofitting abatement equipment onto atmospheric tanks. Relief systems from HCl storage systems are usually connected to scrubbing facilities.

Off-gases from VCM storage tanks are abated with refrigerated reflux condensers, or by connecting to VCM recovery system or to another appropriate vent treatment technique. Vents from the monomer recovery and blanketing systems should be routed to a thermal or catalytic oxidiser. Remote shut-off valves for VCM storage can be installed. Some other specific techniques for VCM storage include.

- Fire protection to prevent overheating and collapse (tanks and their supports are insulated and/or equipped with water deluge facilities)

- Tanks are located in a containment area with walls less than one meter high so that vapour does not accumulate, and graded so that any liquid leakage does not remain beneath the tank. The containment area should also be capable of retaining any fire-fighting water.
- Pressure relief is normally direct to atmosphere and systems are usually duplicated (with appropriate interlock protection) so that valves can be maintained and tested. Where liquid entrainment in the relieved gas is probable or liquid overfill is a reasonable possibility, an expansion tank may be installed before the final release to air. BAT for storage vents is passing to the thermal/catalytic oxidiser.

Emissions from loading /unloading

Emissions of EDC/VCM can arise from the decoupling of pipe connections if they are not fully evacuated beforehand. BAT provisions require to purge coupling connections to EDC/VCM recovery or a thermal/catalytic oxidiser. The installation of vapour return (closed-loop) systems greatly reduces EDC/AVCM emissions when loading mobile tanks (trucks, railcars or ships) as the gas flow between the supplying and receiving tanks are in balance and is also considered BAT. Alternatively, and particularly for remote loading/unloading operations, any vent flow should be preferably connected to a recovery system. Care must be taken in VCM systems to avoid any increase in oxygen content in order to prevent the formation of vinyl polyperoxide

It is a good Practise to have automatic shut down linked to excess flow detectors and/or gas detectors located near leakage points. In Sweden activated carbon adsorption is used for abating the emissions from the loading of EDC into boats and achieves 99% removal of EDC. This is also a BAT accepted technique.

Fugitive Emissions

Since VCM is known carcinogen there have been strenuous efforts over recent years to minimize workplace exposure and environmental releases, especially from fugitive sources. The techniques for minimizing fugitive emission include (but not restricted to):

- Using pumps/valves/compressors of leak-less type (e.g. canned pumps/ bellow seal valves) or venting to control systems.
- Rupture disc provided upstream of PRV's with monitoring of pressure between rupture disc and PRV. PRV's should preferably sent to thermal/catalytic oxidiser
- Using minimum flange connection. Flange packing of Graffoil type
- Closed loop sampling with quick snapping connections for bombs
- Closed drains for contaminated halogenated hydrocarbon streams. Steam stripping of halogenated hydrocarbons to reduce EDC to less than 1 ppm in effluent.
- Rigid LDAR for early repair of leaking equipment.

BAT for fugitives can achieve the following fugitive release levels:

Volatile chlorinated hydrocarbons from fugitive sources	< 5 kg/hr
EDC in working atmosphere	< 2 ppm (8 mg/Nm ³)
VCM in working atmosphere	< 1 ppm (2.6 mg/Nm ³)

6.5.4 Best Available Techniques for Air Pollution Reduction for ACN:

This section presents air pollution control options starting from process selection. In developing this section, the process specific BAT (Best Available Techniques) identified by European Union are also presented along with control strategies.

Process Selection:

The ammoxidation of propylene in a fluid bed reactor with subsequent recovery of Acrylonitrile is BAT process for ACN production. Both pure air or enriched air (with higher oxygen content) are acceptable BAT although enriched air gives lower off-gas volumes.

Plant Design:

BAT for Acetonitrile is to recover and purify it when a market is available, or to burn it with heat recovery.

BAT for the pure, recovered hydrogen cyanide is to

- Re-use hydrogen cyanide on-site or to sell
- Provide adequately sized flare and/or incineration facilities to destroy hydrogen cyanide when it cannot be re-used
- Minimise the amount and duration of hydrogen cyanide storage

BAT for the ammonium sulphate resulting from the neutralisation of excess ammonia is either crystallization and sale to the fertilizers industry, or treatment in a dedicated unit where sulphuric acid is regenerated.

Process Vents

The following vent streams have to be considered:

- Absorber off-gas
- Flue gas from incinerator/oxidiser
- Miscellaneous vent streams
- Fugitive emission

BAT for the absorber off-gas is minimization followed by treatment:

Minimisation of absorber off-gas volume and pollutant load:

- The priority consists in reducing the amount of the absorber off-gas per tonne of Acrylonitrile by means of a more efficient catalyst and optimised reaction/operation

conditions. This may include use of oxygen enriched air or polymer grade propylene.

- Catalysts are selected to maximize the yield of valuable products (i.e. acrylonitrile, hydrogen cyanide and acetonitrile) and minimise waste production.

Treatment of absorber off-gas

BAT for the remaining absorber off-gas is destruction of the organics in a dedicated thermal or catalytic oxidiser/or in a common purpose incinerator or in a boiler plant (generally give >99% reduction). In all cases, BAT will include heat recovery (normally steam production)

Miscellaneous vent stream are those connected to distillation/storage tanks/loading unloading etc. BAT for the miscellaneous vent streams is treatment in either the absorber off-gas treatment system or a common flare system for total destruction of the organics. Other vent streams may be treated by techniques, such as scrubbing, which will allow the recycling of the recovered components.

The performance of the vent stream treatment system should target Acrylonitrile concentrations (as hourly averages) of <0.5 mg/Nm³ (the detection limit in vents) for oxidation systems and < 5 mg/Nm³ for scrubbing systems.

Storage Emissions

Techniques to reduce emissions include providing Internal floating roof tank or to provide closed vent diverted to a control unit (scrubber). Following additional techniques maybe considered.

- Limit storage of ACN to 6 months
- Apply white paint on exterior surface
- Use Nitrogen blanket to reduce flammable hazards
- Provide minimum storage of hydrogen cyanide
- Provide dykes around tanks to contain spills

Loading/Unloading Emission

Considering their high toxicity, acetonitrile and hydrogen cyanide must be handled in closed systems by providing vapour return systems between tank and road tanker and purging of pipes and couplings. Vents should be further treated in water scrubber.

Fugitive Emissions

BAT techniques include:

- Closed loop sampling with quick snapping connections.
- Proper operating procedures during maintenance.
- Use of completely closed type systems/low leakage components/seals etc.
- Monitoring in workroom environment using fixed/portable devices with rigid LDAR.

BAT incorporates maintaining threshold limits in workplace to 2 ppm ACN and 10 ppm HCN.

The vents from various sources are usually treated in water scrubbers and shall achieve outlet levels of 5 mg/m³ ACN.

Emergency relief vents, which may overload the pollution, control equipment may be flared.

6.5.4.1 Emission Control Priorities for Existing Plants:

Based on above discussions, the following emission control priorities are identified for existing plants:

- Treating absorber off-gas in thermal oxidiser/incinerator
- Providing IFR tank for ACN storage or by providing scrubber for vent emissions.

6.5.5 Best Available Techniques for Air Pollution Reductions for Benzene and Toluene:

Process Description

No BAT process is identified since process selection is dependent on the available feedstock and the desired products.

Combustion Emissions

All aromatic recovery or production facilities use fairly large amount of energy in Pyrolysis gasoline hydrogenation (PGH) / dealkylation and disproportionation processes which employ number of fired process heaters. The required energy is typically achieved by combustion of combination of gas (natural gas or fuel gas) and/or fuel oil from the refinery and/or other lighters from petrochemical complexes and produces emissions of mainly CO₂, SO₂, NO_x, CO and particulates.

- NO_x emissions depend on the type of fuel, used (liquid / gaseous) fuel composition, operating temperatures and equipment design.
- CO emissions are relatively small and mainly arise in poorly controlled combustion processes.
- The levels of SO₂ and TPM depend upon type of fuel used.

There is a growing tendency to incorporate more and more energy integration within aromatic unit and with its surrounding plants. Energy integration is commonly accepted BAT as it reduces pollution due to use of other conventional fuels.

For new furnaces, BAT is the use of Ultra Low NO_x burners (ULNBs) or, alternatively for larger furnaces, a catalytic De-NO_x (SCR) system. For existing furnaces, the BAT decision

will depend on the feasibility of installing ULNBs or SCR considering the plant design, size and layout.

VOC emissions from process

BAT is to minimise the VOC emissions at the design stage and due to the toxic properties of benzene particularly stringent controls are required. BAT is an appropriate selection or combination of the following techniques:

- BAT is to route routine process vents and safety valve discharges to gas recovery systems or, where this is not possible, to flare
- BAT is to use closed loop sample systems to minimise operator exposure and to minimize emissions during the purging step prior to taking a sample. The best closed loop sample systems route the sample loop back into the process. The use of quick release connectors for connecting the bomb reduces the releases of hydrocarbon.
- BAT is the use of closed piping systems for draining and venting hydrocarbon containing equipment prior to maintenance, particularly when containing more than 1 wt % benzene or more than 25 wt % aromatics. Ideally permanent piping is used to minimise the risk of exposure during the breaking of containment
- On systems where the process stream contains more than 1 wt % benzene or more than 25 wt% total aromatics, BAT is preferably the use of canned pumps or, where they are not applicable, single seals with gas purge or double mechanical seals or magnetically driven pumps.
- When fugitive emissions are of particular concern (e.g. for occupational exposures reasons), the BAT for fugitive leaks from rising stem manual or control valves is fitting with bellows and stuffing box, or the use of high integrity packing materials (eg. carbon fibre).
- BAT for compressors is double mechanical seals, or a process-compatible sealing liquid, or a gas seal, or to be seal-less.

Emission from Storage

Pygas and reformat feed stocks are generally supplied from upstream operations by pipeline directly to the production facilities or to intermediate storage. In many cases, the volume of intermediate storage is minimised to limit emissions and the handling of large feedstock volumes. Tanks may also be operated on 'running-gauge' mode (the same import and export rates) to limit the fluctuations in storage volume.

BAT for the bulk storage of aromatics is either

- Double seal floating roof tanks (not for dangerous aromatics such as benzene) or in fixed roof tanks incorporating an internal floating roof with high integrity seals.

- Fixed roof tanks which, for a given product or intermediate, have interconnected vapour spaces and vapour recovery or absorption at a single vent.

Emission from Loading and Unloading

Emission of aromatics during loading/unloading operations to barges, rail cars, or tank trucks can occur from pipe connections if they are not evacuated before decoupling. Exhaust systems provided on tankers should be designed to purge coupling and connections to aromatics recovery or flare systems. Alternately, vapour return systems are provided to re-direct vapours emitted back to storage tanks. BAT for the loading or discharging of aromatics (or aromatics-rich streams) from road tankers, rail tankers, ship and barge is the use of closed vent systems (which include the vehicle itself) and where feasible the bottom-loading of road / rail tankers. BAT for the evolved vapours is connection to either a vapour recovery unit, burner or flare system. High efficiency vapour recovery systems (using a combinations of adsorption, absorption and condensation) are capable of reducing benzene emissions to less than 5 mg/Nm³.

Process specific techniques

Gasoline hydrotreaters

During normal operations, the fuel gas produced in the process is fed directly to the fuel gas system, so as to reduce the flaring emissions and to recover maximum energy. When the hydrogenation reactor have to be depressurized or shutdown (eg. periodic catalyst regeneration) the flaring emissions can be minimized by first depressurizing the reactor to the fuel gas system and then depressurizing to atmospheric pressure by venting to the flare. Vent compression is sometimes used to fully recover some or all of the hydrocarbons vented to the flare system.

Benzene heart cut / second stage hydrogenation / benzene extraction units

The second stage hydrogenation reactor(s) require periodic regeneration to restore catalyst activity. It is good practice to route the regeneration off-gas via the regeneration furnace firebox before release to atmosphere.

BAT for hydrogenation off-gases is combustion in a furnace with heat recovery facilities rather than flare.

Although relief valves provided to safeguard against over-pressurisation in the unit normally vent to a flare system, BAT is to install high integrity 'heat-off' systems in benzene plants. These systems trip the heat input to distillation columns in the event of pressure increase in the equipment This shut downs plants quickly and safely and reduces emissions from flaring.

Toluene hydrodealkylation (HDA)

Processes such as hydrodealkylation (HDA), or disproportionation are operated in severe conditions of temperature (up to 750°C) and pressure (upto 60 bar). These conditions

necessitate very high quality technology to avoid leaks, or other major hazards, and this has a positive benefit for environment protection.

Except flue gas, there are no point sources emitting continuously to air in the HDA process, as all the process vents are directed to the fuel gas network. This fuel gas is exported in most cases or, in some cases, is re-used in the HDA process furnaces. The reaction vents can be separated into a hydrogen-rich gas (which is recycled to the reaction) and a methane-rich gas (which joins the fuel gas system or is directed to the hydrogen production by techniques such as pressure swing adsorption) BAT for HDA includes directing the off-gases to the fuel gas network or subjecting the gases to Hydrogen/methane separation.

Flared Emissions

Beside the general measures to reduce the flared quantities the amount of material sent to the flare network is reduced by maintenance and reliability programmes that avoid plant upsets and spurious trips.

6.5.6 Best Available Techniques for Air Pollution Reduction of xylene

The processes adopted and environmental aspects for xylene production are similar to those for Benzene and Toluene. Xylene plants have aromatics stream, which might contain Benzene and Toluene as impurities or as pure components. The BAT for air pollution reduction are same as those for Benzene and Toluene, as the focus is for prevention of similar types of pollutants.

6.5.7 Emission Control Priorities for Existing Units in India

The emission priorities in India and their control measures are identified as below:

S. No.	Priority Area	Correct / Low Emission Technique
1.	Fugitive emission	<ul style="list-style-type: none"> - Use leakless / completely closed systems (eg. canned pumps) - Use system having vent emissions directed to control / recovery device - Use high quality packing / sealing material (eg use Graffoil packing)
2.	Storage Tanks	<ul style="list-style-type: none"> - Adopt LDAR / have good I and M program - Have IFR tanks / VFR tanks having vent directed to control device
3.	Loading / Unloading bay	<ul style="list-style-type: none"> - Route vent to control / recovery device - No 'dip' system – use metering pumps and auto shut off systems to regulate Benzene pumping
4.	Reduce Emissions to flares / atmosphere	<ul style="list-style-type: none"> - Strengthen environment management system to reduce hydrocarbon losses - Have good Inspection and maintenance program

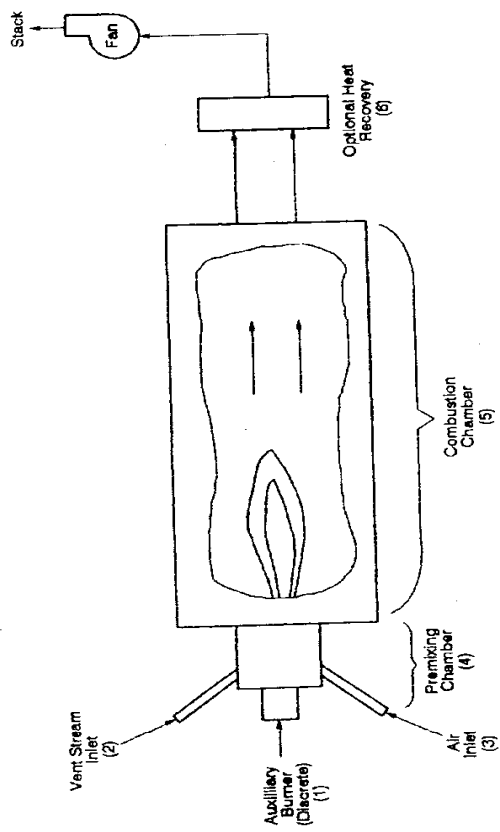

Fig. 6.1: Discrete Burner, Thermal Incinerator

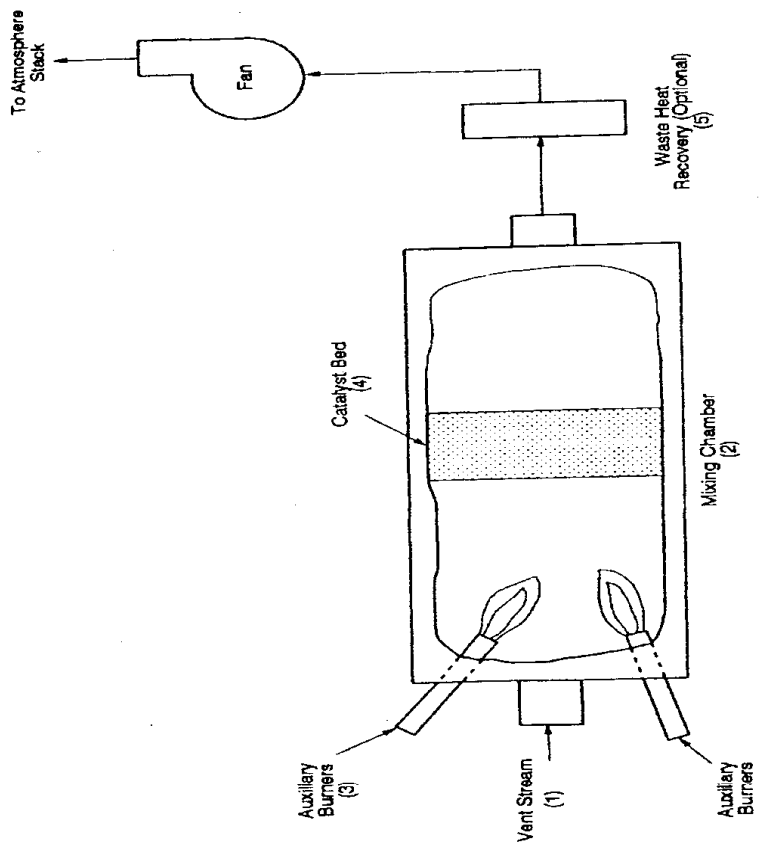

Fig. 6.2: Catalytic Incinerator

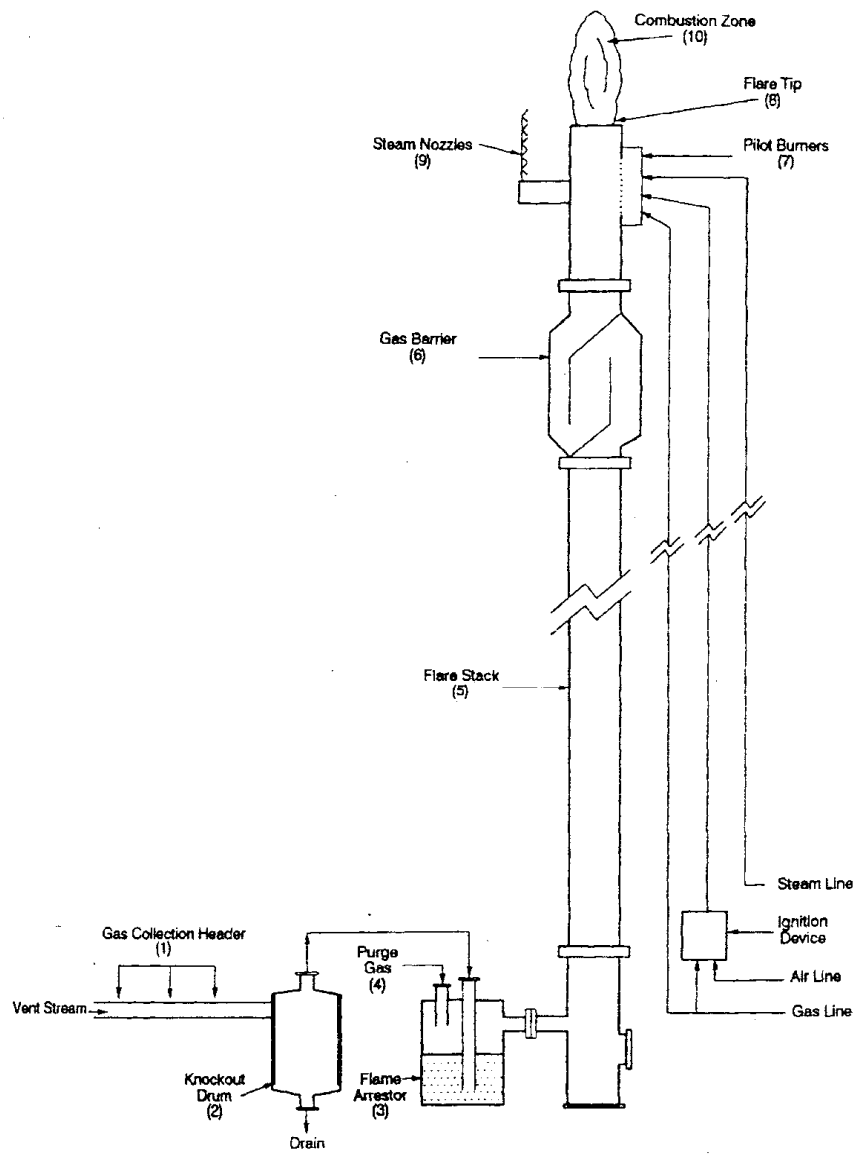

Fig. 6.3: Stream-Assisted Elevated Flare System

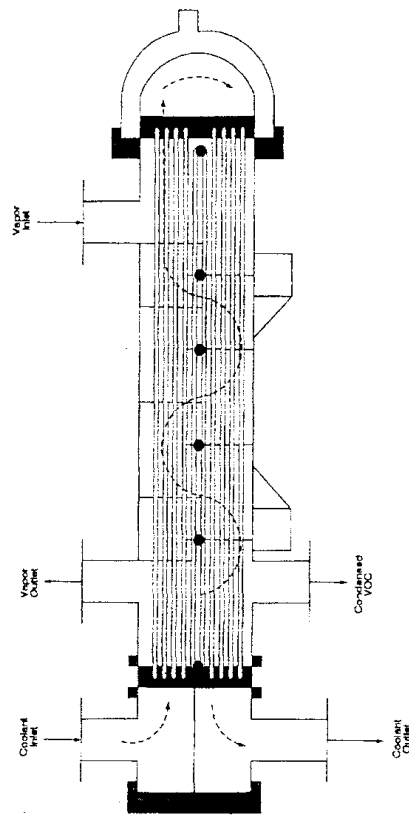

Fig. 6.4: Schematic Diagram of a Shell and Tube Surface Condenser

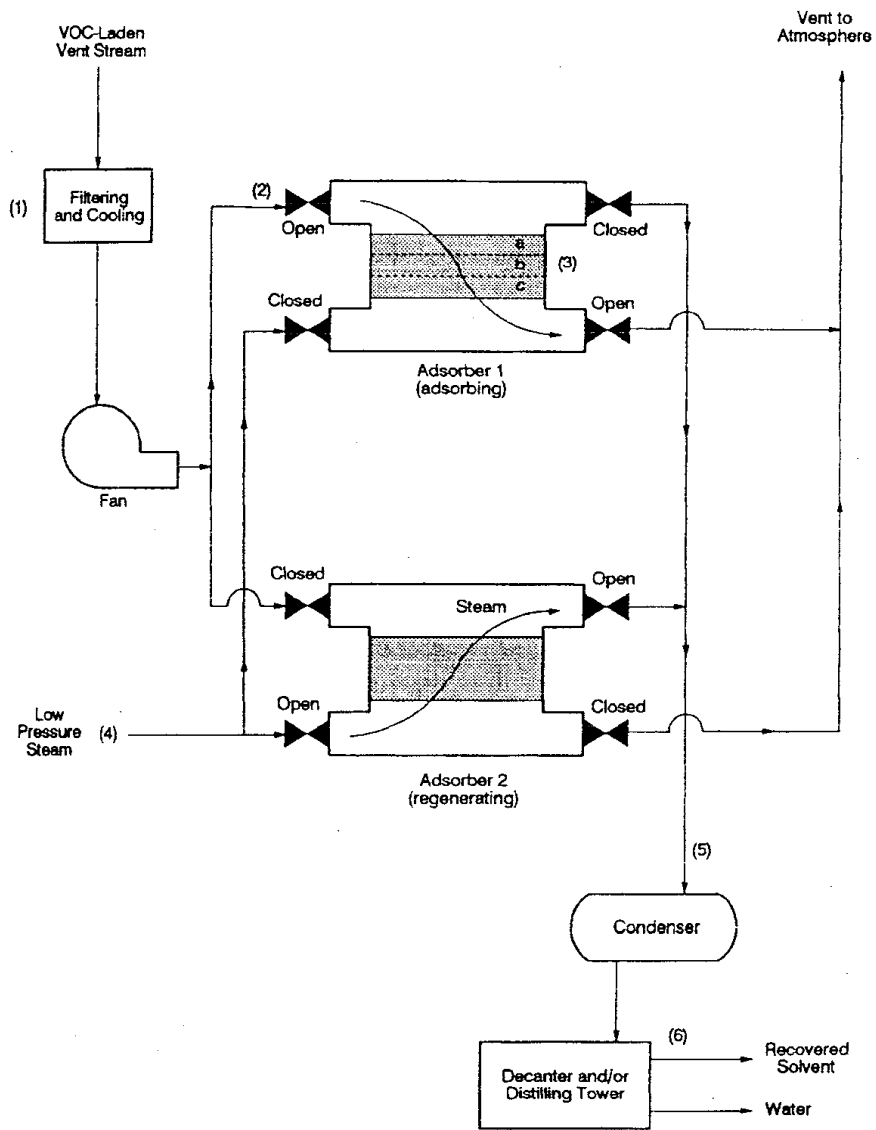

Fig. 6.5: Two Stage Regenerative Adsorption System

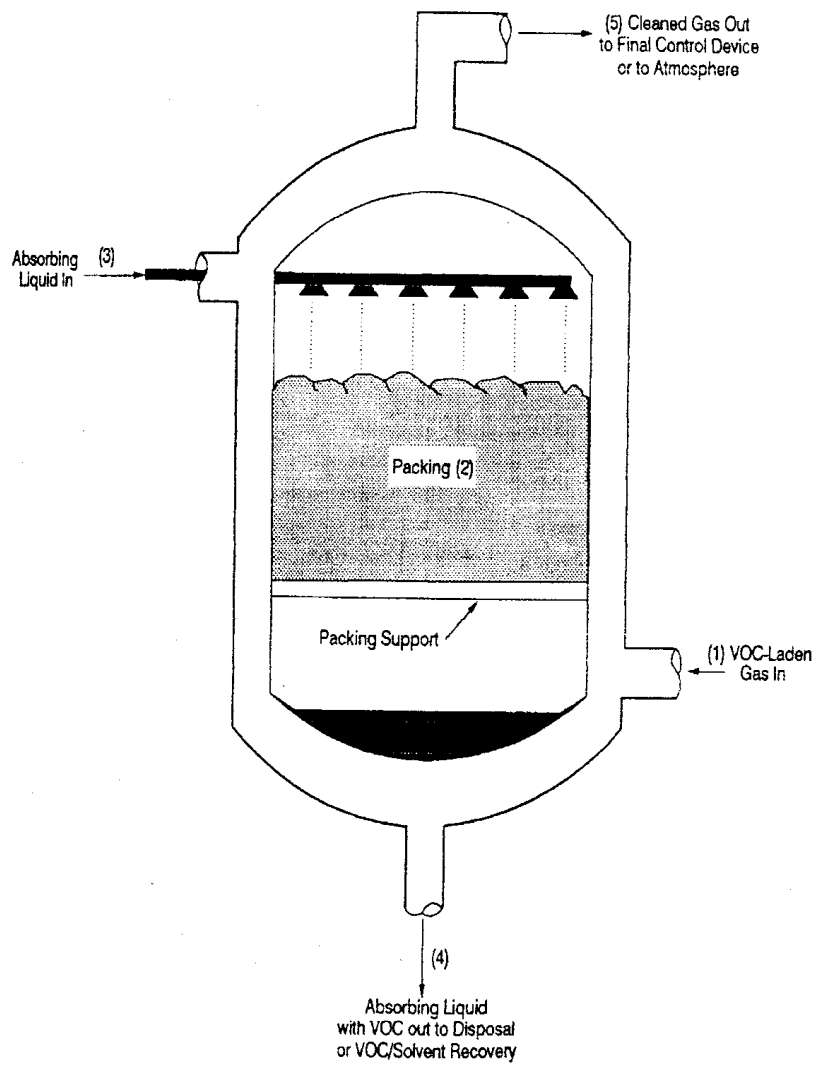

Fig. 6.6: Packed Tower Absorption Process

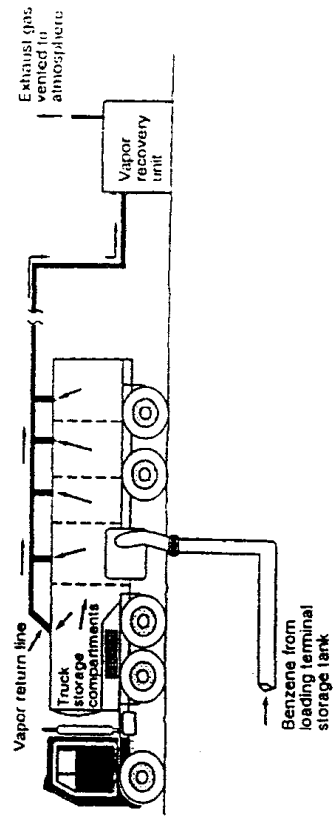

Fig. 6.7: Tank Truck Loading with Vapour Recovery

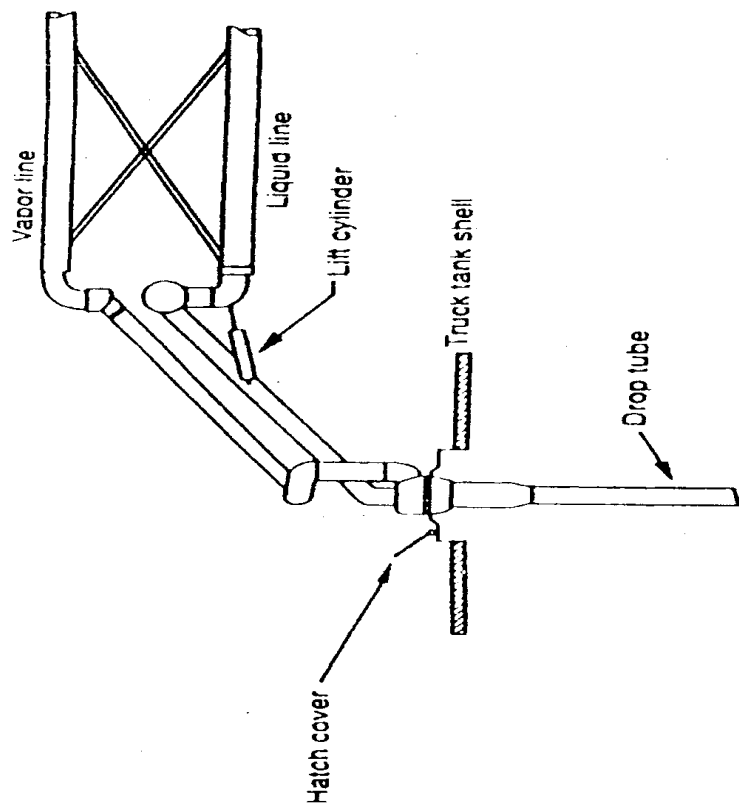

Fig. 6.8: Dual Arm Loading Rack

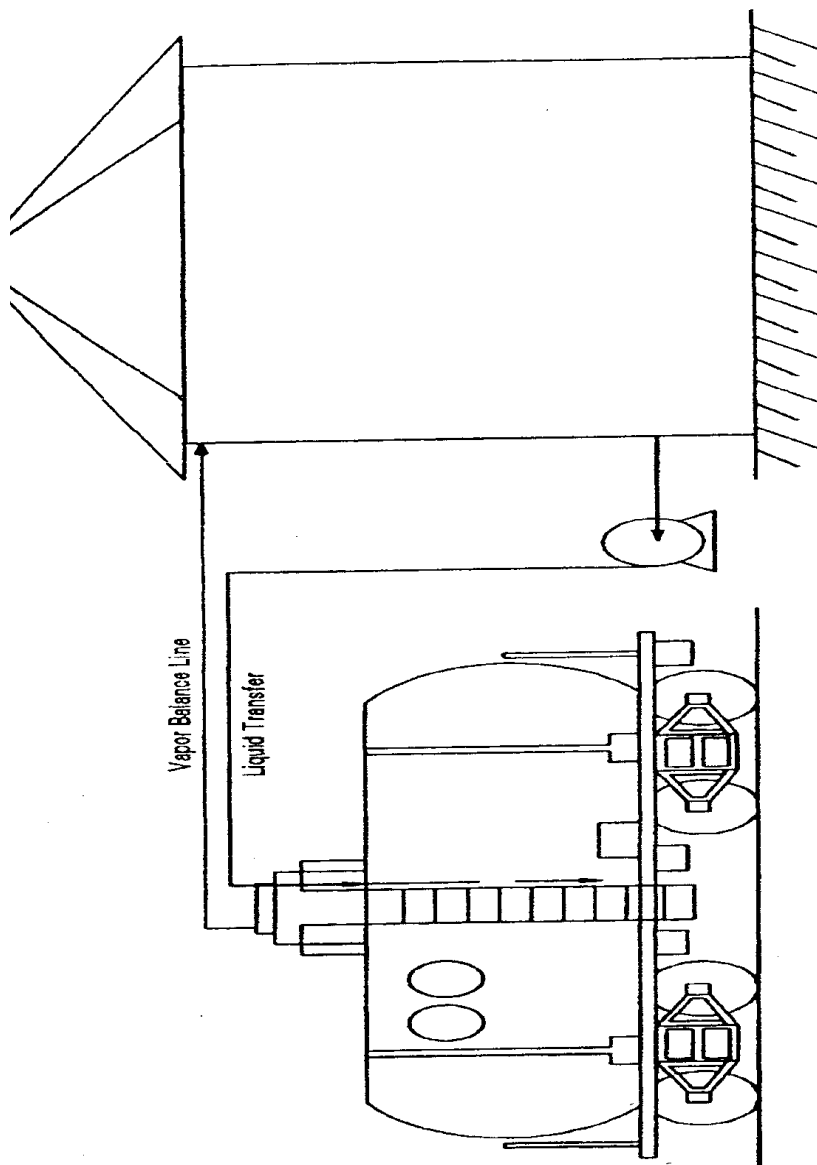

Fig. 6.9: Vapour Balancing System

Chapter 7.0 PROPOSED EMISSION STANDARDS AND LDAR GUIDLINES

7.0 INTRODUCTION

The National Environment Policy (NEP), 2006, with respect to emission standards *i.e.* permissible discharges of specified waste by different class of activities relates to risk to health, sensitive and valuable ecosystem and manmade asset.

The NEP further stated that standard for each class of activities need to be set on the basis of general availability of required technology, the feasibility of achieving the applicable environmental quality standards at the location (specific or category) concerned with the proposed emissions standards, and the likely unit costs of meeting the proposed standard. It is also important that the standard is specified in terms of quantities of pollutants that may be emitted, and not only by concentration levels, since the latter can often be easily met through dilution, with no actual improvement in ambient quality. National Environmental Policy also recommends to eschew the prescribed abatement technology.

Keeping in view of above, the approach for development of emission standard for petrochemical industries is given below:

- Risk reduction related to health, ecosystem and manmade asset
- General availability of required technology and techno-economic feasibility
- Ensure to achieve the ambient air quality standard (location specific)
- Concentration as well as mass based standards

Thus, objective of development of national emission standards for petrochemical industries are as follows:

- (i) Protection of health and environment – addressing mainly release of organic pollutants that are toxic, carcinogenic *etc.* generally in vapour/gaseous state.
- (ii) Protection of local environment from ozone formation by control of VOC and also NO_x emission (contributors to photochemical ozone creation at the ground).
- (iii) Other conventional air pollutant emission to meet the ambient air quality standard.

7.1 Air Pollutant and Risk associated with them

The emission profile from the petrochemical complexes are indicates that the air pollutants can be classified on basis of following factors:

- (i) Toxicity and carcinogenicity - Direct toxicity to human health and other specific ecosystem
- (ii) Photochemical ozone creation potential

- (iii) Ozone destruction potential
- (iv) Global warming potential
- (v) Odour Potential

In view of above, the classification of air pollutants from the petrochemical plants, are as follows:

- i) Conventional parameters
(NO_x, SO₂, PM, CO)
- (ii) Inorganic pollutants from process
(Chlorine, Hydrogen Chloride, Ammonia, HCN, Hydrogen Sulphide)
- (iii) Volatile organic compounds

7.2 Source of pollutants in petrochemical plants considered for development of standards

Sources of pollutants are discussed in detail in Chapter 4. It indicates that the sources can be classified as point sources i.e. release through identified point / conduit, where as the other sources is named as non point source i.e. discrete sources namely equipment leakage known as fugitive emission and from waste water collection and treatment facility.

The conventional parameter such as SO_x, NO_x and particulate matter are released from point sources from heater, furnace, boiler and vaporisers. Emission of the said parameters depend on the nature of feed.

The release of Carbon monoxide (CO) is due to partial oxidation in case of Phthalic anhydride (PA), Malic anhydride (MA), Terephthalic acid (TPA), Dimethyl terephthalate (DMT) production.

With respect to suspended particulate matter, the standard can be prescribed for organic particulate from PA, MA and Toluene di isocyanate (TDI) plant. Particulate matter also release from sources of combustion process, which can be considered for prescribing standards.

It is observed in Chapter 4 that there are Inorganic pollutants, such as chlorine, hydrogen chloride, ammonia, hydrogen cyanide and hydrogen sulphide are also emitted depending on related plant. The observed value of such pollutants and the sources are given in Table 7.1.

Table 7.1: Emission of Inorganic Pollutants from Petrochemical Plants

S. No.	Parameter	Sources	Observed value mg/Nm ³	Plant
1	Chlorine	EDC/VCM plant and incinerator	3.2	Unit-IV
			9	Unit-III
2	Hydrogen chloride	EDC / VCM plant and incinerator	30.4	Unit-IV
			20.0	Unit-III
3	Ammonia	Process vent (w.w. stripper)	72.0	Unit-I
4	HCN (Acrylonitrile Plant)	Process vents	17.1	Unit-I
			16.8	
		Incinerator	3.9	
			1.8	
5	Hydrogen sulphide	Naphtha pre-treatment plant, olefin plant	-	-

7.2.1 Sources of Volatile Organic Compounds (VOCs) emission

The typical sources of VOCs from petrochemical production are:

- (a) Process vents
- (b) The storage and transfer of liquids and gases
- (c) Fugitive i.e. leak sources and
- (d) Vents and pressure relief devices

Besides above, important source of VOC loss is the off-site/disposal system such as

- ⇒ Stripping of wastewater stream (with air or steam) will transfer dissolved organics into the gaseous phase and release to atmosphere.
- ⇒ VOCs from wastewater collection system (e.g. drains, balancing tanks)

- ⇒ VOCs from wastewater treatment facilities (e.g. aeration)
- ⇒ VOCs from storage and treatment of solid wastes /off specific products.

The point sources of VOCs have been well controlled over recent years in the developed countries and the losses of VOCs in fugitive form (from pumps, valves, tanks etc.) have become major source of VOCs emission from petrochemical plants.

Table 7.2 represent typical VOC emissions from petrochemical point and non-point sources. The raw material & product handling (particularly loading and unloading) operations are the major sources of point source emissions from petrochemical plants.

Table 7.2 : VOC Emission from Point and Non-Point Source

Key point emission sources

Raw material / product storage and handling	:	75 – 90%
Process vents	:	5 – 15%
Flare / Incinerator etc.	:	5 – 10%

Key non-point emission sources

Process fugitive emission	:	70 – 80%
Blow down, Slop, Wastewater collection and Treatment	:	20 – 30%

Process equipment components – responsible for fugitive emission

Valves (including Control Valves)	:	40 – 45%
Pumps	:	20 – 27%
Relief Valve	:	15 – 20%
Compressors	:	5 – 10%
Sampling point / drains	:	1 – 2%
Flanges	:	3 – 5%

7.3 Approach to Emission Regulation

7.3.1 Conventional Parameters

Among the conventional parameters / air pollutants (viz. SO_x, NO_x, PM, CO etc.), NO_x is more critical due to its adverse local effect of ground level ozone formation potential, thus deserve special attention. The other parameters mainly SO_x, SPM & CO result from combustion sources viz. furnaces, heaters, boilers, power generation plants. Norms / regulation for these parameters are to be adopted in harmony with the norms already stipulated by CPCB, earlier in other industry sector.

7.3.2 Inorganic pollutants

The Central Pollution Control Board has already laid down standards for inorganic pollutants (gases) for some of the industry sectors. It is observed that gases emitted (Refer Table 7.1) have harmful effects both on vegetation and human health. Since control of these pollutants is necessary, measures adopted are cost effective considering best practicable technology.

Norms, therefore, are required to be adopted in harmony with the norms already stipulated for other industry sectors.

7.3.3 VOC Control

Control of VOC is the major focus area of air emission standards for petrochemical industries. Two categories of VOCs i.e. VOC- HAPS (volatile organic compounds which are hazardous air pollutants) that are identified having direct impact to human health with respect to toxicity & carcinogenicity and VOCs-general, which causes photochemical smog or emits odorous substance, are considered for emission regulation of petrochemical industries.

The VOCs-HAPS are identified/selected on the basis of internal practices in other countries viz. USA, Germany, Netherlands, Japan, UK etc. and also as per the classification of international bodies viz. IARC etc. VOCs (general) pollutants are grouped and limits set on the basis of techno-economic feasibility for the existing production plants, the possible expansion and also the new grass root plants in future.

It is observed that the Indian petrochemical production units' adopt/select the technology of manufacturing sourced from international licensors. The manufacturing techniques adopted by these licensed processors meet the environmental emission limits stipulated in other countries. Thus, the existing manufacturing units particularly involved in emitting VOCs-HAPS can adopt suitable design, engineering practices and improved/high integrity hardwares and add on systems over the years during the annual maintenance and also during expansion to address and control all emissions classified as point sources emission. The non-point sources emission resulting from equipment leakage (known as fugitive emission)

can be addressed immediately as per the general guidelines. For new facilities, it is imperative that the regulation and the limits are adopted immediately.

In view of above, two things need to be understood. One is the status of petrochemical industry and emission control in India; the second one is the best practicable technology.

7.4 Present status of emission control

During the study of the industries, the following were observed and also confirmed by air sampling and analysis:

- (a) A few production units responsible for VOCs-HAPs emission have recently adopted adequate measures to control within the plant by installation of higher integrity equipments (viz. canned motor pumps etc.)
- (b) The naphtha feed storage for olefin and aromatic complex is found to be the major source of VOCs-General emission. However, some units have initiated steps to adopt new or convert existing tanks to External Floating Roof (EFR) or Internal Floating Roof (IFR) storage to reduce the Naphtha losses.
- (c) In petrochemical industries, large atmospheric tank storage relates to naphtha and aromatic products (benzene, toluene and xylene) which need to be retrofitted with EFR or IFR with proper sealing. However, some units have initiated retrofitting because of economic reason. The other intermediate/final products (Acrylonitrile, EO, P.O., Epichlorohydrin, Toluene Di-isocyanate, VCM etc.) are stored as per the international practices (bullets and Horton spheres) with the vent connected to flare or incinerator.
- (d) Product-loading stations are definitely the area of concern in Indian petrochemical industry. Reliable engineering of the system and appropriate equipment need to be adopted to meet the norms/regulation for this potential point source emission.
- (e) Leak detention and repair (LDAR) programme is already practiced by Indian petrochemical industry but needs a common guideline.

Best available technology has already discussed in Chapter 6.

7.5 Proposed National Emission Standards

Considering the status of emission control by Indian industries and best practicable technology, the emission standards for petrochemical industries are proposed as below.

7.5.1 Emission standards for heater/furnace/boilers/vaporisers

S. No.	Parameter		Maximum emission limit (mg/Nm ³)	
			Existing plants	New plants/ Expansion
1	NOx	Gas firing	350	250
		Liquid firing	450	350
2	SOx	Gas firing	50	50
		Liquid firing	1700	850
3	CO*	Gas firing	150	100
		Liquid firing	200	150
4	PM	Gas firing	10	05
		Liquid firing	100	50

Notes:

1. All values are corrected to 3% O₂.
2. At the time of decoking, wet scrubber shall be operated.

* Norms for Carbon monoxide shall be applicable in case of Phthalic Anhydride (PA), Maleic Anhydride (MA), Terephthalic Acid (PTA) and Dimethyl Terephthalate (DMT) Plants

7.5.2 Emission standards for organic particulates

S. No.	Petrochemical compound	Maximum Emission limit (mg/Nm ³)		Mass flow limit (gm/hr)
		Existing plant	New plants/ Expansion	
1	Phthalic anhydride (PA), Maleic anhydride (MA), Toluene Di- isocyanate (TDI)	50	25	100*

* - Mass flow limit (gm/hr) is applicable for new plants and expansion plants.

7.5.3 Emission standards for process emission (specific Inorganic pollutants)

S. No.	Parameter	Source	Maximum emission Limit (mg/Nm ³)
1	Chlorine	EDC / VCM plant and incinerator	10
2	HCl	EDC / VCM plant and incinerator	30
3	Ammonia	Process vent (wastewater stripper) acrylonitrile plant, caprolactum plant	75
4	H ₂ S	Naphtha pre-treatment plant, olefin plant	05
5	Phosgene	Generated in TDI and MDI plants	01
6	HCN	Acrylonitrile plant	10

7.5.4 Emission standards for VOCs-HAPs from process vents

S. No.	Parameters	Maximum emission Limit		
		Existing plant (mg/Nm ³)	New plants/ Expansion	
			(mg/Nm ³)	(gm/hr)
1	(Toluene Di-isocyanate) TDI, Methylenediphenyl Di-isocyanate (MDI)	0.1	0.1	0.5
2	Benzene, Butadiene	5.0	5.0	25.0
3	EO, VCM, EDC, ACN, PO	20.0	10.0	50.0

7.5.5 Emission standards for VOCs (general) from process vents

S. No.	Petrochemical process / compounds	Maximum emission Limit (mg/Nm ³), dry basis
1	MA, PA, Phenol	20
2	Ethyl benzene (EB), Styrene, Toluene, Xylene, Aromatics, EG, PG	100
3	Non-methane HC (paraffin), Acetone, olefins	150

7.5.6 Standards for storage and transfer point (loading and unloading)

7.5.6.1 Standards for atmospheric storage tanks of petrochemical products

S. No.	True Vapour Pressure (TVP), kPa at 20 0C	Storage Tank Capacity (M ³)
1	> 10	4 – 75
2	10 – 76	75 – 500
3	10 – 76	> 500
4	> 76	> 75

Notes:

1. Requirement for seals in Floating Roof Tanks:
 - (i) IFRT & EFRT are to be provided with secondary seal with minimum vapour recovery of 96%.
 - (ii) Primary seal will be liquid or shoe mounted for EFRT and vapour mounted for IFRT. Maximum seal gap width will be 4 cm and maximum gap area will be 200 cm²/m of tank diameter.

- (iii) Secondary seal will be rim mounted. Maximum seal gap width will be 1.3 cm and maximum gap area will be 20 cm²/m of tank diameter.
 - (iv) Material of seal and construction should ensure high performance and durability.
2. Fixed Roof Tanks will have vapour control efficiency of 95% or vapour recovery/balancing efficiency of 90%.
 3. Inspection and maintenance of storage tanks should be carried out under strict control. For the inspection, API RP 575 may be adopted. In-service inspection with regard to seal gap, should be carried out once in every six months and repair to be implemented in short time. In future, possibility of on-stream repair of both seals will be examined.
 4. Tanks shall have paint with white colour shade, except for derogation of visually sensitive area.

7.5.6.2 Storage of Benzene, VCM and ACN

For storage of benzene, VCM and ACN, following shall be followed:

1. FRT with vapour to incineration with 99.9% of removal efficiency for volatile organic compounds (VOC).
(OR)
2. EFRT with double seals, emission-reducing roof fitting and fitted with fixed roof with vapor removal efficiency of at least 99%.
(OR)
3. Internal floating roof and nitrogen blanketing in between fixed and floating roofs.

7.5.7 Standards for emission from loading of volatile products

S. No.	Item	(Standards) Maximum emission limit
1	Naphtha: (i) VOC reduction, % (or) (ii) Emission, gm/m ³	(i) 99.5 % (or) (ii) 5 gm/m ³

S. No.	Item	(Standards) Maximum emission limit
2	Benzene and Butadiene: (i) VOC reduction, % (or) (ii) Emission, mg/m ³	(i) 99.99 % (or) (ii) 20 mg/m ³
3	Toluene/Xylene: (i) VOC reduction, % (or) (ii) Emission, mg/m ³	(i) 99.98 % (or) (ii) 150 mg/m ³

7.6 LDAR Guidelines

7.6.1 Guidelines for atmospheric storage tank practices

- (i) For true vapour pressure up to 10 kPa with tank capacity in the range of 4-75 m³, Fixed Roof Tank (FRT) with pressure valve vent may be provided.
- (ii) For true vapour pressure of 10-76 kPa with tank capacity in the range of 75-500 m³, Internal Floating Roof Tank (IFRT) or External Floating Roof Tank (EFRT) or Fixed Roof Tank with vapour control or vapour balancing system may be provided.
- (iii) For true vapour pressure more than 10-76 kPa with tank capacity more than 500 m³, Internal Floating Roof Tank or External Floating Roof Tank or Fixed Roof Tank with vapour control system may be provided.
- (iv) For true vapour pressure more than 76 kPa with tank capacity more than 75 m³, Fixed Roof Tank with vapour control system may be provided.

7.6.2 LDAR and monitoring protocol

Leak detection and repair (LDAR) programme include (i) Block valves; (ii) Control valves; (iii) Pump seals; (iv) Compressor seals; (v) Pressure relief valves; (vi) Flanges – Heat Exchangers; (vii) Flanges – Piping; (viii) Connectors – Piping; (ix) Open ended lines; and (x) Sampling connections. Equipment and line sizes more than 2.54 cm are to be covered.

LDAR programme would be applicable to components (given at 2 above) for following products/compounds: (i) hydrocarbon gases; (ii) Light liquid with vapour pressure @ 20°C > 1.0 kPa; and (iii) Heavy liquid with vapour pressure @ 20°C between 0.3 to 1.0 kPa.

LDAR programme would not be applicable for (i) heavy liquids with vapour pressure < 0.3 kPa, it will be desirable to check for liquid dripping as indication of leak (ii) Equipment and line sizes less than 2.54 cm, less than 300 hr service and in vacuum service. (iii) Equipments and piping during start up and shut down. (iv) Pumps (canned, diaphragm, magnetic), Valves (Diaphragm, bellow) and close loop Sampling points; and (v) Non-access able points to the extent of 5% of total plant.

A leak is defined as the detection of VOCs concentration more than the values (in ppm) specified below at the emission source using a hydrocarbon analyser according to measurement protocol (US EPA – 40 CFR part 60 Appendix-A, method 21 for determination of VOC leaks may be referred):

S. No.	Component	HAPs (General) in ppm		Volatile HAPs* in ppm	
		w.e.f. 1.1.07	w.e.f. 1.1.10	w.e.f. 1.1.07	w.e.f. 1.1.10
1	Pump / Compressor	10000	5000	3000	2000
2	Valves / Flanges	10000	3000	2000	1000
3	Other components	10000	3000	2000	1000

Note: * - Benzene, butadiene, VCM, EDC, ACN, EO, PO

In addition, any component observed to be leaking by sight, sound or smell, regardless of concentration (liquid dripping, visible vapour leak) or presence of bubbles using soap solution should be considered as leak.

Following frequency of monitoring of leaks and schedule for repair of leaks shall be followed:

S. No.	Component	Frequency of monitoring	Repair schedule
1	Valves/ Flanges	Quarterly (semi-annual after two consecutive periods with < 2% leaks and annual after 5 periods with < 2% leaks)	Repair will be started within 5 working days and shall be completed within 15 working days after detection of leak for general hydrocarbons. In case of benzene, the leak shall be attended immediately for repair.
2	Pump seals	Quarterly	
3	Compressor seals	Quarterly	
4	Pressure relief devices	Quarterly	
5	Pressure relief devices (after venting)	Within 24 hours	
6	Heat Exchangers	Quarterly	
7	Process drains	Annually	
8	Components that are difficult to monitor	Annually	
9	Pump seals with	Weekly	

S. No.	Component	Frequency of monitoring	Repair schedule
	visible liquid dripping		
10	Any component with visible leaks	Weekly	Immediately
11	Any component after repair/replacement	Within a week	-

Following types of monitoring methods may be judiciously employed for detection of leaks: (i) Photo ionisation detector (PID) or flame ionisation detector (FID) Instrumental method of measurement of leaks; (ii) Audio, visual and olfactory (AVO) leak detection; and (iii) Soap bubble method.

Data on time of measurement & concentration value for leak detection; time of repair of leak; and time of measurement & concentration value after repair of leak should be documented for all the components.

Pressure relief and blow down systems should discharge to a vapour collection and recovery system or to flare.

Open-ended lines should be closed by a blind flange or plugged.

Totally closed-loop should be used in all routine samples.
Low emission packing should be used for valves.

High integrity sealing materials should be used for flanges.

7.6.3 General notes

1. Emission monitoring shall be carried out as per the Emission Regulations – Part III, published by Central Pollution Control Board.
2. Following methods may be used for measurement of pollutant concentrations in the emissions:

S. No.	Parameter	Method of measurement
1	Sulphur Dioxide (SO ₂)	USEPA CFR – 40 Part 60 Appendix A Method 6
2	Oxides of Nitrogen (NO _x)	USEPA CFR – 40 Part 60 Appendix A Method 7
3	Particulate Matter (PM)	USEPA CFR – 40 Part 60 Appendix A Method 5
4	Carbon Monoxide (CO)	USEPA CFR – 40 Part 60 Appendix A Method IOA / Combustion analyzer with electro chemical detect or / NDIR detector

**B-1
BIBLIOGRAPHY**

1. CEFIC 2000, Lower Olefins Process BREF
2. Rentz, N., Laforsch, Holtmann (1999) Technical Background document for the actualisation & assessment of UN/ECE protocol related to the abatement of the trans boundary movement of VOC's from stationary sources, French German Institute for Environmental Research.
3. EC DGXI (1992) Identification & Brief Description of the Emissions (Water, Air & Waster from the Different Sectors of the Organic Chemical Industry, European Commission, ChemInform
4. Infomil (2000), Dutch Notes on BAT for the Large Volume Organic Chemical Industry.
5. USEPA (1993) Alternative Control Techniques Document NOx emissions from process heaters.

**B – 5
BIBLIOGRAPHY**

1. CEFIC (2000) : Ethylene oxide / Ethylene glycol process BREF : Chapter 4 Candidate BAT
2. Locating & Estimating Document – Ethylene oxide, USEPA.

**B - 6
BIBLIOGRAPHY**

1. PARCOM (1996) # 22, Best Available Techniques for the Vinyl Chloride Industry, Oslo & Paris Commissions.
2. CEFIC (2000) # 105, EDC /VCM Process BREF, Chapter 4 condidate BAT
3. Integrated Pollution Prevention & Control (IPPC) (Feb'02) Reference Document on Best Available Techniques in the Large Volume Organic Chemical Industry
4. HMIP UK (1993) # 100, Process Guidance Note IPR 4/17 – Bulk Storage Installations.
5. Environment Agency (E & W) (1998) # 1, Best Available Techniques for the Control of Pollution in Petrochemicals & Large Volume Organic Chemical Processes, Chemical System Ltd.

6. OSPAR (1998) # 79, "Decision 98/4 on emission & discharge limits for the manufacture of Vinyl Chloride Monomer including the manufacture of EDC".
 1. Morris Katz, Methods of Air Sampling & Analysis – APHA
 2. Pradyot Patnaik, Handbook of Environmental Analysis – Lewis pub, 1997.
 3. David T. Allen, Pollution Prevention for Chemical Processes – A. Wiley – Inter science, 1997.
 4. Calvin R. Bronner, Hazardous Air Emissions from Incineration – Chapman & Hall
 5. Neol De Nevers, Air Pollution Control Engineering – Mcgraw Hill
 6. Bela G. Liptak, Analytical Instrumentation – Randor, 1994.
 7. Lawrence H. Keith & Mary M. Walkor, Handbook of Air Toxics – Lewis, 1995.
 8. Paul J. Lioy & Mery Jean Y. Lioy, Air Sampling Instruments – American Conference of Govt. Industrial Hygienists
 9. Liv Liptak, Environmental Engineers Handbook – Lewis, 1997
 10. Estimating Fugitive Emission - Internal Document, Rohm & Hass Co. Ltd.
 11. Locating & Estimation, Documents for Benzene, Toluene, Xylene, EO, EDC, Acrylonitrile
 12. Air Pollution Emission Factors AP 42 USEPA
 13. USEPA Methods for Air Analysis
 14. Sax N.I., 1997 "Dangerous Properties of Industrial Chemicals "
 15. NIOSH / OSHA " Pocket Guide to Chemical Hazards" pub. No. 78-210
 16. Inspection Tool for the Hazardous Organic NESHAP (HON), Inspection checklists, USEPA (Vol. I / Vol. II)
 17. Integrated Pollution Prevention & Control (IPPC), Reference Document on Best Available Techniques in the Large Volume Organic Chemical Industry Feb. 2002. European Commission, (Vol. I / Vol. II)
 18. The Categorisation of Volatile Organic Compounds, HMIPI, UK Process Guidance Note.

19. Large Volume Organic Chemicals, Environment agency, IPC S2 4.01, Environment Agency, UK
20. Guidance on Effective Flaring in the Gas, Petroleum, Petrochemical and Associated Industries, ISBN 0-11-752916-8