

METHODS & STANDARD OPERATING PROCEDURES (SOPs) OF EMISSION TESTING IN HAZARDOUS WASTE INCINERATOR

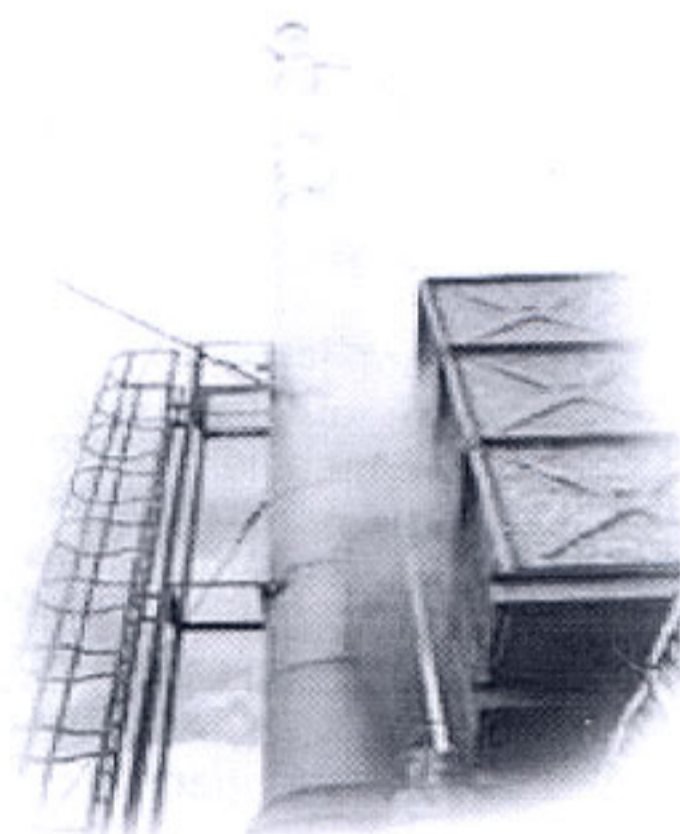

CENTRAL POLLUTION CONTROL BOARD
(Parivesh Bhawan, East Arjun Nagar, Delhi – 110 032)

September 2007

METHODS & STANDARD OPERATING PROCEDURES (SOPs) OF EMISSION TESTING IN HAZARDOUS WASTE INCINERATOR

FOREWARD

COVR PAGE

TEAM

CHAPTER	TITLE	PAGE NO
<u>Chapter - 1</u>	<u>Stack Monitoring – Material And Methodology For Isokinetic Sampling</u>	1-28
<u>Chapter - 2</u>	<u>Standard Operating Procedure (SOP) For Particulate Matter Determination</u>	29-38
<u>Chapter - 3</u>	<u>Determination Of Hydrogen Halides (Hx) And Halogens From Source Emission</u>	39-54
<u>Chapter - 4</u>	<u>Standard Operating Procedure For The Sampling Of Hydrogen Halides And Halogens From Source Emission</u>	55-61
<u>Chapter - 5</u>	<u>Determination Of Metals And Non Metals Emissions From Stationarysources</u>	62-79
<u>Chapter - 6</u>	<u>Standard Operating Procedure (Sop) For Sampling Of Metals And Non Metals</u> & <u>Standard Operating Procedure (Sop) Of Sample Preparation For Analysis Of Metals And Non Metals</u>	80-97
<u>Chapter - 7</u>	<u>Determination Of Polychlorinated Dibenzo-P-Dioxins And Polychlorinated Dibenzofurans</u>	98-127
<u>Chapter - 8</u>	<u>Standard Operating Procedure For Sampling Of Polychlorinated Dibenzo-P-Dioxins And Polychlorinated Dibenzofurans</u> & <u>Standard Operating Procedure For Analysis Of Polychlorinated Dibenzo-P-Dioxins And Polychlorinated Dibenzofurans</u>	128-156

Project Team

- | | | | |
|-----|--|---|--|
| 1. | Dr. B. Sengupta, Member Secretary | - | Overall supervision |
| 2. | Dr. S.D. Makhijani, Director | - | Report Editing |
| 3. | Sh. N.K. Verma, Ex Additional Director | - | Project co-ordination |
| 4. | Sh. P.M. Ansari, Additional Director | - | Report Finalisation |
| 5. | Dr. D.D. Basu, Senior Scientist | - | Guidance and supervision |
| 6. | Sh. Paritosh Kumar, Sr. Env. Engineer | - | Report processing |
| 7. | Sh. Dinabandhu Gouda, Env. Engineer | - | Data compilation, analysis and preparation of final report |
| 8. | Sh. G. Thirumurthy, AEE | - | - do - |
| 9. | Sh. Abhijit Pathak, SSA | - | - do - |
| 10. | Ms. Trapti Dubey, Jr. Professional (Scientist) | - | - do - |
| 11. | Er. Purushotham, Jr. Professional (Engineer) | - | - do - |
| 12. | Sh. N.S. Babu, Ex Env. Engineer | - | Project Initiation |
| 13. | Sh. K. P. Rathi, DEO Gr-II | - | Secretarial assistance |
| 14. | Sh. Atul Sharma, JLA | - | Secretarial assistance |

CHAPTER- 1

STACK MONITORING – MATERIAL AND METHODOLOGY FOR ISOKINETIC SAMPLING

**Method-1
(Part- I)****Stack Monitoring – Material and Methodology for Isokinetic Sampling****1.0 SOURCE EMISSION MONITORING**

This section deals with the method of source emission monitoring. It also gives the minimum requirement of a stack monitoring equipment.

1.1 Specifications of Stack Monitoring Equipment**Table 1.1: Specifications of Stack Monitoring Equipment**

S. N	Item/Equipment	Specifications/Applicable ranges
General Requirements		
1	Stack Velocity Range:	0 to 30 m /sec <i>For low velocity range differential pressure determination should be done by differential manometer</i>
	Stack Temperature	Range: 0 to 600 °C
	Particulate Sampling:	At 10 to 60 lpm
	Filter Paper (Thimble):	Collection of particulates down to 0.3 micron
	Gaseous sampling:	At 1 to 2 lpm collection on a set of impingers containing selective reagents.
2	Pitot tube	i. Pitot tube shall be modified “S- type” fabricated from SS 304 or equivalent grade. The construction feature should be as per United States Environmental Protection Agency (EPA) regulation, Method 2, Given in Figures 1.1 and 1.2 (A) ii. The construction feature shall be such that the coefficient of the pitot tube is above 0.95.
3	Sampling probe	Sampling probe shall be fabricated from SS 304 tube of suitable diameter (not less than 15 mm Internal diameter (ID). The SS probe should have inner glass liner to facilitate sampling for metals, acids(HCl) and PCDDs and PCDFs. Length of pitot tube and the sampling probe may correspond to user requirement.
4	Nozzles	Nozzles shall be fabricated with SS 304 or equivalent material with internal diameters suitable to cover the full range of stack velocities. The leading edge of the nozzle should be sharp and tapered. The minimum internal diameter of the nozzle shall not be less than 8 mm. Glass nozzles are recommended for Hx and halogens, metals and PCDDs/PCDFs sampling
5	Heated filter box	Heated filter box upto 130 ⁰ c with filter holder made of glass is recommended
6	Sample transfer line	Heated sample transfer line (upto 130 ⁰ c) made of nonreactive, non corrosive material is recommended to eliminate artifacts due to condensation
7	Thermocouple	Thermocouple sensor shall be provided with analog or digital dial gauge capable of measuring temperature from 0 to 600 ⁰ C covered with stainless steel or mild steel casing with acid resistant treatment.

8	Mounting flange	A pair of male/female flanges fabricated with mild steel with proper hole for mounting thermocouple sensor, sampling tube and pitot tube.
9	Panel box sides	Panel box sided shall be fabricated with aluminium/mild steel/fiber glass sheets with oven-baked stove-enamel finish. It should have suitable arrangement for housing stop- watch, manometer, rotameter, dry gas meter etc.
10	Back panel	Back panel shall be hinged door panel of mild steel to contain cold box with 8-10 impingers.
11	Inclined - cum - Vertical Manometer	Inclined- cum – vertical manometer shall be fabricated with soild acrylic sheets. It shall be provided with Inlet and outlet for filling in gauge fluid and spirit level for leveling. Velocity range of the manometer shall be 0 to 30 m/sec.
12	Rotameters	0 to 60 lpm for particulate monitoring and 0 to 3 lpm for gaseous monitoring
13	Stop-watch	0 to 60 minutes, one second readout with hold facility.
14	Impinger	Four number 100 ml and four to six number 225 ml capacity. Facility should be there for keeping ice at the bottom of impinger box. Electrical cooling is desirable.
15	Connectors	Push and close type quick connector to ensure better leak proofness
16	Vacuum pump	Vaccum pump shall be of rotary design, with a capacity of to 0 to 120 lpm gas flow with single phase motor, 220 V. The pump shall also have a moisture trap and air inlet valve. It shall be mounted inside pump housing and shall be portable.
17	Dry gas meter	The sampling train shall have a dry gas meter with the facility for measuring temperature and static pressure. The capacity of the meter should be adequate to record upto 60 lpm of airflow and a minimum readout of 0.001 cubic meters.
18	Pump housing	Mild steel case with oven- baked stove enamel finish and ON/OFF switch with indicator lights.
19	Tools	A Kit containing the essential tools for connecting various components shall be provided with the equipment.
20	Isokineticity	The kit shall be capable to perform continuous monitoring of isokinetic condition through out the sampling period
21	Temperature at metering point	Temperature measuring device at metering point shall be provided (0-50 ⁰ c)
22	Vaccum measurement	Digital/analog vaccum pressure drop measurement device in mm Hg should be provided in stack kit.
23	Train leakages	The sampling train shall be tested for leakage by plugging the inlet. The rotameter shall not give a reading beyond 5 lpm when the flow has been set at 100 lpm. The dry gas meter shall also give a reading of less than 5 percent of the airflow.

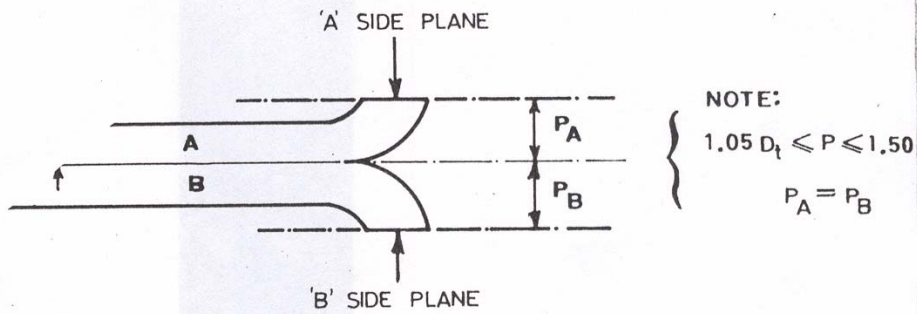

(a)

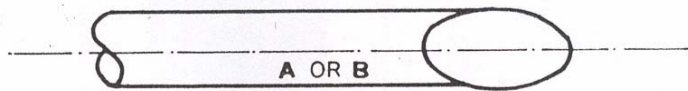

(b)

Properly constructed Type S pitot tube shown in: a) Top view; face opening planes parallel to longitudinal axis; b) side view; both legs of equal length and central lines coincident, when viewed from both sides. Baselines coefficient values of 0.84 may be assigned to pitot tubes constructed this way.

FIGURE 1.1 "S - TYPE" pitot tube construction

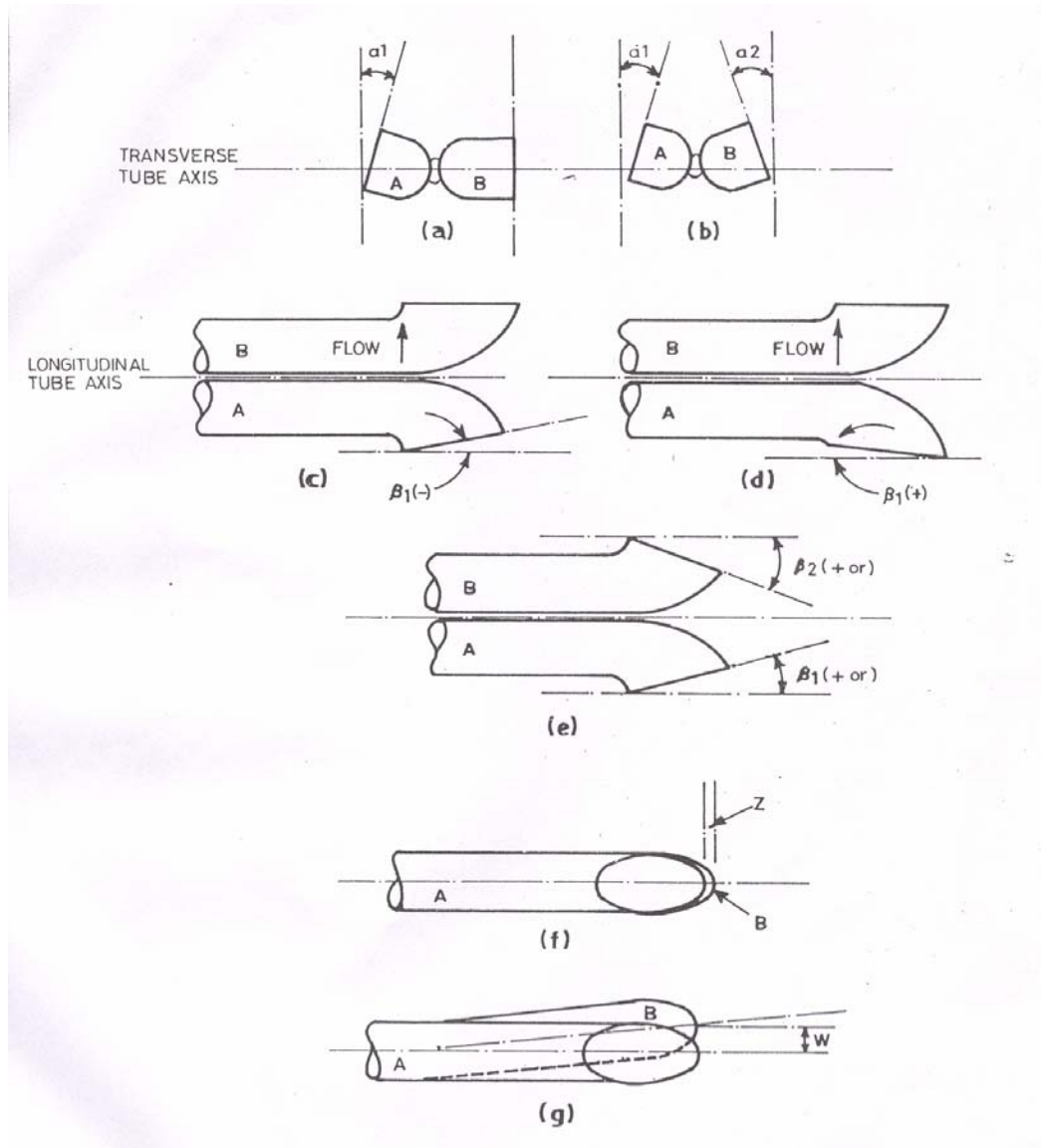

Types of face opening misalignment that can result from field use or improper construction of type S pitot tubes. These will not effect the baseline of $C_p(s)$ so long as a_1 and $a_2 < 10^\circ$, β_1 and $\beta_2 < 5^\circ$, $z < 0.32 \text{ cm}$ (1/8 in.) and $w < 0.08 \text{ cm}$ (1/32 in.)

FIGURE 1.2 (A) 'S - TYPE' pitot tube construction

1.2 Method of Testing

1.2.1 Molecular weight determination

- Dry and wet molecular weights

Equation 1 is used to calculate the dry molecular weight of flue gas. This equation may be modified with terms if other gaseous constituents that will influence the molecular weight if present. Equation 2 is used to calculate the molecular weight of the sample is used to calculate the molecular weight of the gas on a wet basis.

Calibrated multiple combustion gas analyzer may be used to know the percentile composition of flue. Orset analysis may also serve the same purpose.

$$M_d = 0.44 (\%CO_2) + 0.32 (\% O_2) + 0.28(\% N_2 + \% CO) + \dots \text{Eq- 1}$$

$$M_s = M_d (1 - B_{wo}) + 18 B_{wo} \text{Eq-2}$$

0.44 – molecular weight of carbon dioxide divided by 100, kg/kg-mole

0.32 – molecular weight of oxygen divided by 100, kg/kg –mole

0.28 – molecular weight of nitrogen and carbon monoxide divided by 100, kg /kg-mole

B_{wo} - proportion by volume of water vapour in stack gas.

18 - molecular weight of water, Kg / Kg -mole

Note: % N_2 is calculated by difference. In the majority of cases the following equation may be used:

$$\% N_2 = 100 - (\% CO_2 \text{ avg} + \% O_2 \text{ avg} + \% CO \text{ avg.})$$

Where,

M_d = molecular weight of stack gas on dry basis, kg / kg –mole.

M_s = molecular weight of stack gas on wet basis, kg / kg –mole

$\% CO_2$ = Percent CO_2 by volume, dry basis

$\% O_2$ = Percent oxygen by volume, dry basis

$\% N_2$ = percent nitrogen by volume, dry basis

1.2.2 Static pressure determination

- For the static pressure determination requires first to disconnect the positive end of the pitot tube then take the reading of velocity pressure. Use the following formula for the calculation. For measurement of static gas pressure pitot tube should be rotated by 90° from the position of actual ΔP measurement. This would provide better accuracy.

P_s may be calculated as

$$P_s = P_{\text{bar}} \pm (\Delta P_s / 13.6)$$

Where:

P_{bar} = Barometric pressure in mm mercury column

ΔP_s = Stack gas velocity pressure, mm water column

P_s = Static pressure mm Hg column.

Density of Hg = 13.6

1.2.3 Stack gas velocity determination

For velocity determination connect pitot tube to the stack as given in **Fig 1.2 (B)**. The dynamic and a static pressure are measured by using the manometer. The temperature inside the duct is also measured. The velocity of gas in the duct and the air quantity are determined using the following formula.

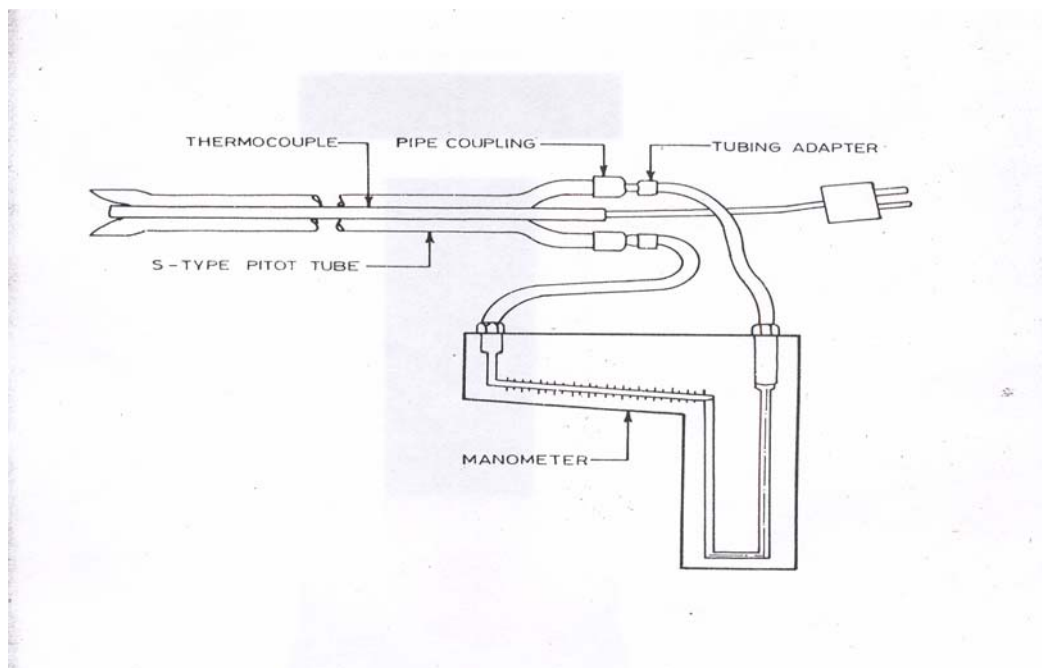

FIGURE 1.2 (B) “S – TYPE” pitot tube and inclined manometer assembly

1.2.3.1 Preliminary determination

Preliminary determination requires for the parameters like Temperature (Stack & ambient temperature °C), velocity pressure Head ΔP , Ambient Barometric pressure, Static pressure as mentioned in the above paragraph.

$$U_s = K_p C_p (\Delta P)^{1/2} \left[\frac{T_s}{P_s \times M_s} \right]^{1/2}$$

Where

U_s = Stack gas velocity, m/s

K_p = Constant, 33.5

C_p = S- type pitot tube coefficient.

T_s = absolute stack gas temperature, °K

ΔP = Stack gas velocity pressure, mm water column

P_s = Absolute stack gas pressure, mm Hg

M_s = Molecular weight of stack gas on wet basis, Kg / Kg –mole

1.2.3.2 Stack gas volumetric flow Rate

The following equation is used to calculate the stack gas volumetric flow rate, Q_s (m^3/hr).

$$Q_s = 3600 (U_s) \times A_s (1-B_{wo}) \times \left[\frac{T_{ref}}{T_s} \right] \left[\frac{P_s}{P_{ref}} \right]$$

A_s = Area of the stack (duct), m^2

B_{wo} = Proportion by volume of water vapour in stack gas.

T_{ref} = 298 °K

P_{ref} = 760 mm

T_s = Absolute stack gas temperature, °K

P_s = Absolute stack gas pressure

1.2.4 Moisture determination

The moisture content may be determined either by condenser method or by wet / dry bulb method temperature and then referring to a suitable psychrometric chart. Latter should be limited to non-acid gas streams with moisture content of less

than 15 percent and dew point less than 52°C. The condenser method works well for most gas streams and also relative easy to perform.

1.2.4.1 Condenser method

The condenser method, in principle, involves extracting a sample of the stack gases through a filter for removal of the particulate matter, then through a condenser, accumulating the condensate formed in process, and finally through a gas meter. The object of the test is to collect and measure the volume of all the condensate formed at the condensing temperature from a measured amount of gas.

- Apparatus – The apparatus necessary for determination of moisture content by the condensate method is given below.

Table 1.2 : Apparatus for determination of moisture content

S. No.	Apparatus	Description
1	Particulate Sampling Apparatus	Consisting of a probe of stainless steel or pyrex glass, sufficiently heated to prevent condensation and equipped with a filter to remove particulate matter.
2	Condenser	It is equipped with temperature gauge. This may be substituted with two condenser bottles in an ice bucket, each with 30 ml capacity or equivalent. The condenser /condenser bottles are filled with chilled water.
3	Dry Gas Meter	To measure within 5 percent of the total sample volume.
4	Gauges	Two thermometers (range 0 – 100 °C), two calibrated vacuum gauges or U- tube manometers (range 0 – 500 mm mercury).
5	Gas Pump	Leak free diaphragm type or equivalent, for sucking gas through sampling apparatus.
6	Fittings	Tubing (rubber, neoprene, etc.), rubber stoppers and flow control (needle- valve and shut –off ball valve).

- Procedure – Except in unusual circumstances, the water vapour is uniformly dispersed in the gas stream and therefore sampling for moisture determination need not be is kinetic and is not sensitive to position in the duct. The sampling nozzles may be positioned down –stream to minimize the build up of pressure drop across the thimble due to particulates catch. Sample the gas at a rate of about 500 ml/ sec. Run the test until enough condensate has been collected to enable an accurate measurement. Measure the temperature and pressure of condenser close to the meter, as an insignificant pressure loss in the line between them is expected. The meter pressure may be substituted for condensate pressure also in order to calculate the moisture content. Measure the volume of condensate collected in a graduated measuring cylinder.

- Calculations

Calculate the volume of water vapour collected using the following equation:

$$V_v = \frac{(V_c \times 22.4)}{1000 \times 18} \times \frac{T_m}{273} \times \frac{760}{P_{\text{bar}} - P_m}$$

V_v = Equivalent vapour of condensate under sampling condition, m^3

V_c = Volume of condensate in condensor, ml

T_m = Temperature at metering condition, $^{\circ}\text{K}$

P_m = Suction at meter, mm mercury column

P_{bar} = Barometer pressure, mm mercury column

Calculate the moisture content of the gases using the following equation:

$$B_{\text{wo}} = \frac{V_v}{V_v + V_m}$$

$$M = \frac{V_v}{V_v + V_m} \times 100$$

Where

M = Moisture in the flue gases, percent

V_v = Equivalent vapour volume of condensate under sampling condition.

V_m = Volume of gas sampled (m^3)

1.2.4.2 Wet / dry bulb method

The equilibrium temperature attained by water, which is vapourizing adiabatically into gas of composition and constant dry bulb or actual temperature, is termed as wet bulb temperature. The amount of depression of the wet bulb temperature below the dry bulb temperature is a function of the degree of saturation of the humidity of the gas. Therefore, the moisture content of the gas can be determined from the wet and dry bulb temperature.

- Calculations – the moisture content may be determined from the test data using a psychrometric chart. The percentage water vapour by volume is found directly. Inputs are the dry bulb temperature and wet bulb temperature.

1.3 Selection of Sampling Site and Minimum Number of Traverse Points

Select the sampling site at any cross section of the stack or duct that is at least eight stack or duct diameters downstream and two diameters upstream from any flow disturbance such as bend, expansion, contraction, visible flame, or stack exit (see inlet, **Figure 1.3**). For rectangular cross section, the larger dimension shall be used to represent the stack diameter.

1.3.1 When the above sampling site criteria can be met, determine the minimum number of traverse points required, from **Table 1.3**. The minimum required number of traverse points is a direct function of stack or duct diameter.

1.3.2 When a sampling site such as described in 1.3 is not accessible, choose a convenient sampling location and use **Table 1.3 and Figure 1.3** to determine the minimum required number of traverse location to the nearest upstream and downstream disturbance. First, measure the distance from the chosen sampling location to the nearest upstream and downstream disturbance. Then, from **Figure 1.3** determine the corresponding sample points multiples for both distances and select the greater of these. Multiply it by the number obtained from Table 1.3. The result of this calculation is the minimum number of traverse points required. This number may have to be increased such that for circular stacks the number is a multiple of 4 and for rectangular stack the number follows the criteria given in 1.3.4

1.3.3 Cross- section layout and location of traverse points

For circular stack divide the cross section into equal parts by two right- angle diameters. Locate half the traverse points symmetrically along each diameter according to **Figure 1.4 and Table 1.4**.

1.3.4 For rectangular areas as there are traverse points as many equal rectangular areas traverse points such that the ratio of the elements/ area is between one and two. Locate the traverse points at the centroid of each area according to **Figure 1.4**

1.3.5 Under no condition shall sampling points be selected within 3 cm of the stack wall.

Table 1.3 : Minimum required number of traverse points for sampling sites which meet specified criteria

Inside diameter of stack or duct (m)	Number of points
$I.D. \leq 0.3$	4
$0.3 \leq I.D. \leq .6$	8
$0.6 \leq I.D. \leq 1.2$	12
$1.2 \leq I.D. \leq 2.4$	20
$2.4 \leq I.D. \leq 5$	32

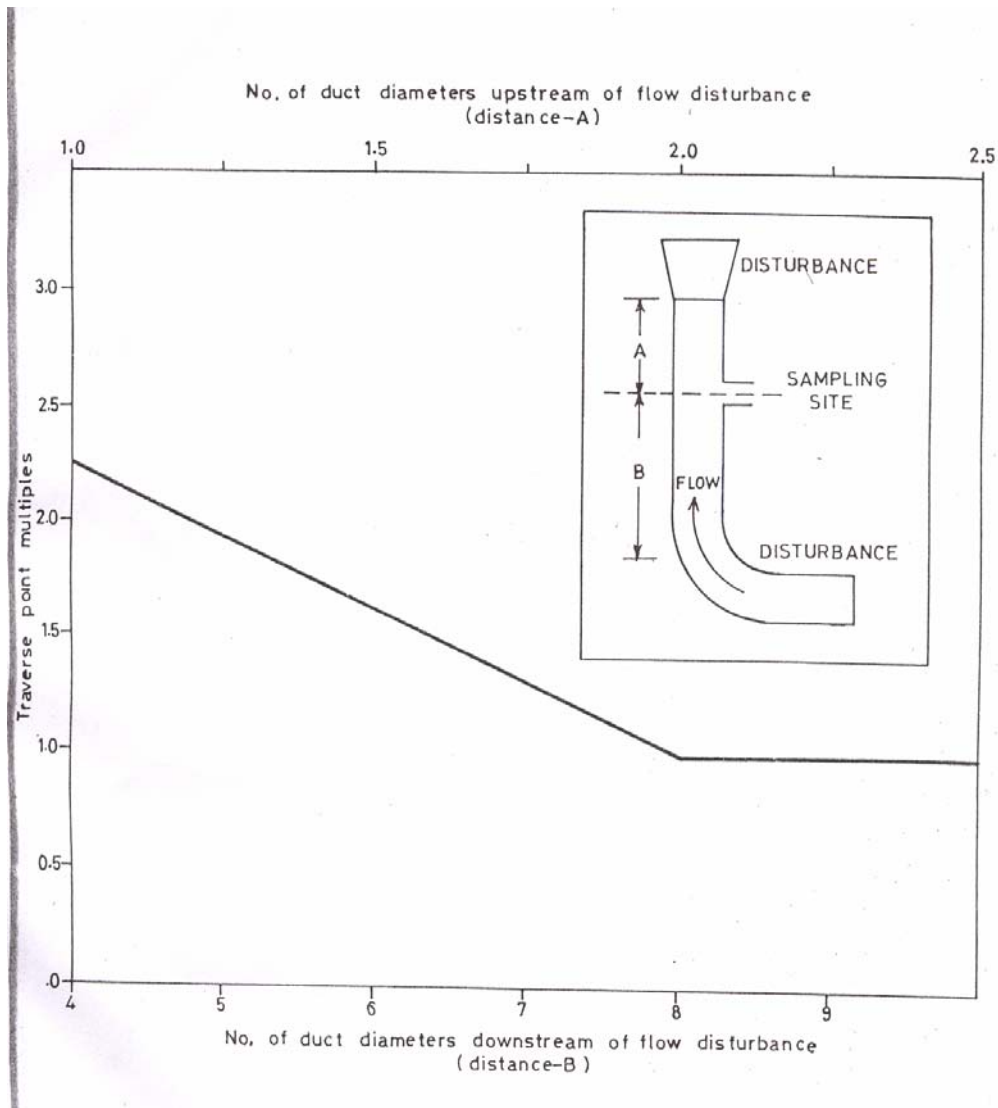
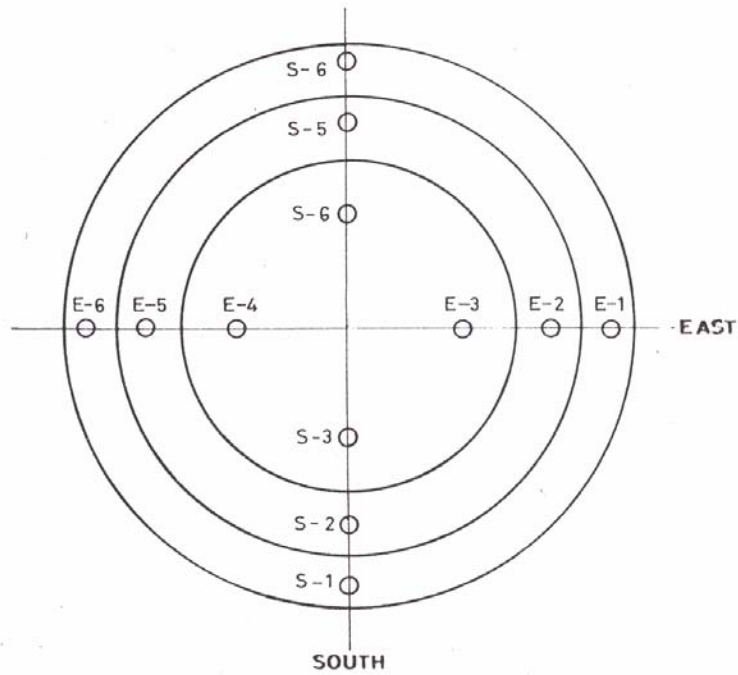

FIGURE 1.3 Travers point multiples to determine minimum number of traverse points requirement when $a < 2$ dia or $b < 8$ dia



A	A-1 ○	A-2 ○	A-3 ○	A-4 ○
B	B-1 ○	B-2 ○	B-3 ○	B-4 ○
C	C-1 ○	C-2 ○	C-3 ○	C-4 ○

FIGURE 1.4 Location of traverse points on circular and rectangular cross section divided into twelve equal areas

TABLE – 1.4 Location of traverse points on diameters of cross section of circular stacks

TRAVERSE POINT NUMBER ON A DIAMETER	PERCENT OF STACK DIAMETER FROM INSIDE WALL TO TRAVERSE POINT											
	Number of traverse points on a diameter.											
	2	4	6	8	10	12	14	16	18	20	22	24
1	14.6	6.7	4.4	3.3	2.5	2.1	1.8	1.6	1.4	1.3	1.1	1.1
2	85.4	25.0	14.7	10.5	8.2	6.7	5.7	4.9	4.4	3.9	3.5	3.2
3		75.0	29.5	19.4	14.6	11.8	9.9	8.5	7.5	6.7	6.0	5.5
4		93.3	70.5	32.3	22.6	17.7	14.6	12.5	10.9	9.7	8.7	7.9
5			85.3	67.7	34.2	25.0	20.1	16.9	14.6	12.9	11.6	10.5
6			95.6	80.6	65.8	35.5	26.9	22.0	18.8	16.5	14.6	13.2
7				89.5	77.4	64.5	36.6	28.3	23.6	20.4	18.0	16.1
8				96.7	85.4	75.0	63.4	37.5	29.6	25.0	21.8	19.4
9					91.8	82.3	73.1	62.5	38.2	30.6	26.1	23.0
10					97.5	88.2	79.9	71.7	61.8	38.8	31.5	27.2
11						93.3	85.4	78.0	70.4	61.2	39.3	32.3
12						97.9	90.1	83.1	76.4	69.4	60.7	39.8
13							94.3	87.5	81.2	75.0	68.5	60.2
14							98.2	91.5	85.4	79.6	73.9	67.7
15								95.1	89.1	83.5	78.2	72.8
16								98.4	92.5	87.1	82.0	77.0
17									95.6	90.3	85.4	80.6
18									98.6	93.3	88.4	83.9
19										96.1	91.3	86.8
20										98.7	94.0	89.5
21											96.5	92.1
22											98.9	94.5
23												96.8
24												98.9

1.4 Location of Sampling Port

To ensure laminar flow, sampling ports shall be located at atleast 8 times chimney diameter down stream and 2 times up stream from any flow disturbance. For a rectangular cross section the equivalent diameter (De) shall be calculated by using following equation to determine up stream, down stream distances.

$$De = \frac{2 LW}{L+W}$$

Where L =Length in m, W= width in m.

Sometimes it may so happen for existing chimneys that sufficient physical chimney height is not available for desired sampling locations. In such cases additional traverse points shall be taken as explained at section 1.3.

1.4.1 Number of sampling ports

The pitot tubes commercially available in the country generally do not exceed 2 meter in length. Any points on the horizontal cross-section of a stack (chimney) along any diameter can be measured for flow by the pitot tube, if the point is approachable. Inserted pitot tube through the sampling port (hole) for stacks with diameter less than 2m. Minimum two (mutually orthogonal) sampling ports are required in a circular chimney, so that full stack cross-sectional area can be covered for measurements.

For stacks having diameter between 2 and 4 meters, two mutually orthogonal sampling ports are to be increased to four by providing additional sampling ports at diametrically opposite position, to the first two sampling ports (**Fig 1.5**)

1.4.2 Dimensions of sampling port

Port Type: Pitot tube, temperature and sampling probe are to be inserted together into the sampling port for monitoring purposes. Sampling port should be a standard flanged pipe of 0.10 m inside diameter (ID) with 0.15 m bolt circle diameter. An easily removable blind flange should be provided to close the port when not in use.

Port Installation: Flanged pipe used as port should be installed with the interior stack wall. Port should extend outward from the exterior stack wall not less than 50 mm and not more than 200 mm only when additional length is required for gate valve installation. Ports should be installed at a height between 0.90 and 1.2 m above the floor of the working platform.

Port Loading: The port installation should be capable of supporting the following loads:

- A. Vertical shear of 91 Kg
- B. Horizontal Shear of 23 Kg and
- C. Radial tension of 23 Kg (along stack diameter)

- (1) A_1, A_2 WHEN $D < 2\text{ M}$
- (2) A_1, A_2, B_1, B_2 WHEN $D \geq 2\text{ M}$

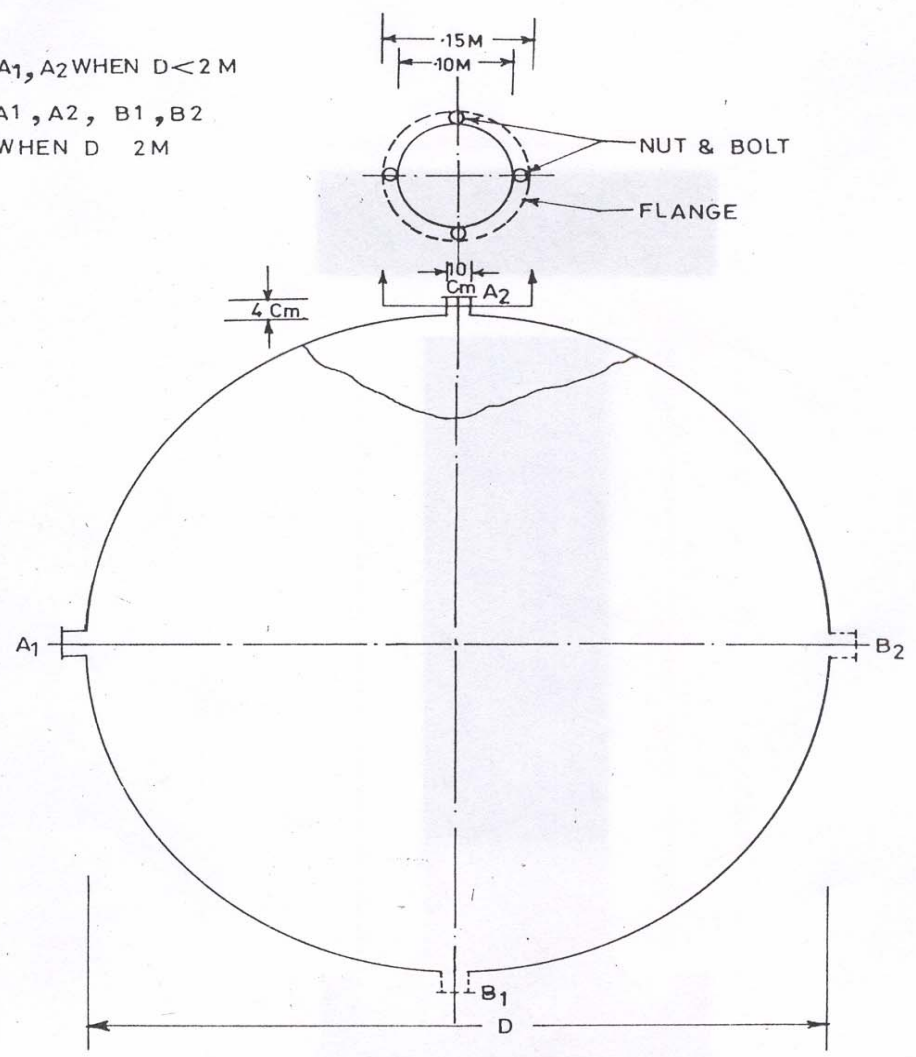

FIGURE 1.5: Position of sampling ports in a circular chimney

1.4.3 Features of platform for stack sampling

Size and extent of platform for sampling: If two ports are required at 90 degree the work platform should serve that half of the stack circumference between the ports and extend at least 1.2 meters beyond each port. If four ports are required at 90 degree, the work platform should serve the entire circumference of the stack. Minimum platform width shall always be 1.2 meters regardless of diameter of stack and number of sampling ports. A typical platform for sampling is shown in **Figure 1.6**.

1.4.4 Platform access

Safe and easy access to the work platform should be provided via caged ladder, stairway, or other suitable means.

Guardrails, Ladder wells and Stairwells: A safe guardrail should be provided on the platform. Angular rail is preferable than round rail member. No ladder well, stairwell, or other such openings should be located within 1 meter of any port. Ladderwells should be covered at the platform. Any stairwell leading directly to the platform should be equipped with a safety bar at the opening.

1.4.5 Platform loading

The work platform should be able to support at least three men (Average 80 Kg each) and 91 Kg of test equipment (stack monitoring kit, etc.). If the stack exists through a building roof, the roof may suffice as the work platform, provided the minimum test sites required are complied with.

1.4.6 Clearance zone

A three- dimensional, obstruction free clearance zone should be provided around each port. The zone should extend 0.6 m above, below, to either side of the port. The zone should extend outward from the exterior wall of the stack to a distance of at least 3 meters. The clearance zone is illustrated in **Figure 1.6**.

1.4.7 Power Supply

Power supply shall be as follows:

- A. Platform- one 220 volts, 15 amp, single phase AC circuit with a grounded, two receptacle weatherproof outlet.
- B. Stack base- one 220 volts, 15 amp, single phase AC circuit with a grounded, two receptacle weatherproof outlet.

1.4.8 Vehicle access and parking

Except for situations in which sampling operation must be conducted from a rooftop or similar structure, stack sampling is sometimes coordinated and controlled from a monitoring van, which is usually parked near the base of the stack for the duration of the sampling period. Vehicle access and parking space must be provided, since various equipment transport lines will be strung from the monitoring van to the stack platform and will remain in position during the sampling.

1.4.9 Additional requirements

In addition to above aspects, the sampling platform, guardrails etc. should also be regularly painted and checked for corrosion. There should be no leakage around the sampling port (specially needed for stacks emitting corrosive chemicals).

If anticorrosive lining is done inside the chimney, the same should be extended to the projected portion of the sampling port, monolithically. Improper lining at the port reduces chimney life considerably. Sampling port should be air tight and moist air should not be allowed to enter the chimney.

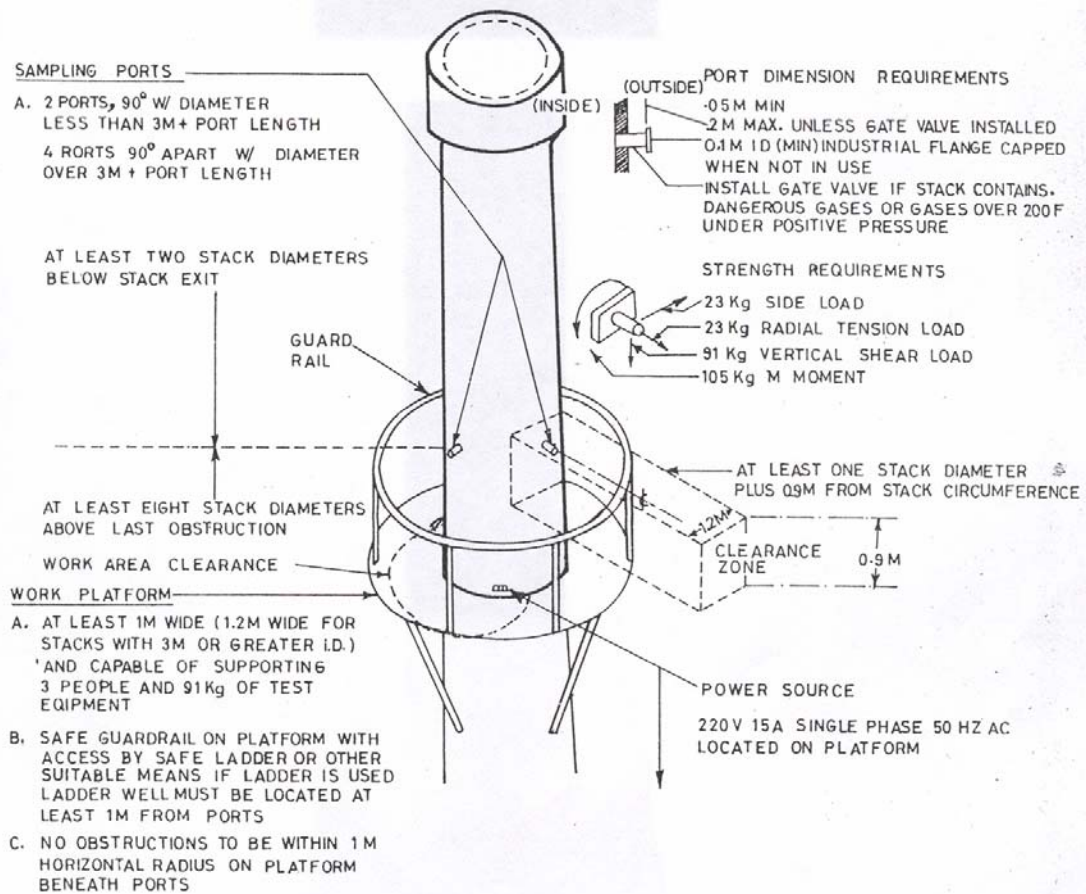

FIGURE 1.6: Typical sampling provision

2.0 REFERENCES

1. Comprehensive Industry Document Series: COINDS/ 20/ 1984 - 85,
Central Pollution Control Board

Method – 1 (Part- II)

Determination of particulate matter emissions from stationary sources

1.0 PRINCIPLE

Determination of particulate concentration consists of isokinetic sampling of a measured amount of gas from the flue gases and separating the particles from the gas and hence determining the particulate concentration. To ensure representative sample, the kinetic energy of the gas stream in the stack should be equal to kinetic energy of the gas stream through the sampling nozzle.

2.0 APPLICABILITY

This method is applicable for determination of particulate matter (PM) emissions from stationary sources. This is for sampling of particulate matter in a moving gas stream in a duct or a stack. These procedures utilize particulate filtering systems, which are located within the stack. If properly used, these systems are satisfactory for determining the mass concentration of particulate matter in the gas stream at stack condition. The use of collection systems located outside the stack for collecting samples at other than in-stack condition is an alternative.

3.0 INTERFERENCES

It has been observed that, if sampling velocity is greater than the isokinetic rate, the sampling will have a lower mass concentration of particulate material than the main stream because of greater percentage of fine particles. However, if the sampling velocity is less than the isokinetic rate, the particulate sample has a higher mass concentration than actually present, with lower concentration of fine particles.

4.0 SAMPLING

Sampling at other than isokinetic velocities induces errors for two reasons. First, sampling at greater or less than isokinetic rates tend to cause respectively a larger or a smaller volume to be withdrawn from the flue gases than accounted for by the cross section area of the probe. Secondly, particles greater than 3.5 micron in size have sufficient inertia so that particle motion may deviate significantly from the gas flow streamline pattern.

4.1 The Sampling Consists Of Several Distinct Steps. Refer 1.2 of Stack Monitoring – Material and Methodology for Isokinetic Sampling (Method-1)

5.0 PROCEDURE FOR PARTICULATE MATTER DETERMINATION

5.1 Selection of Location of Sampling

Sample for particulate concentration shall be done at the same be traverse points where velocity measurements were carried out.

5.2 Calculation of Proper Sampling rate

The meter for measuring the gas sample measures the gas at conditions of temperature, pressure and moisture content which are different than those in the flue. Therefore, calculate the sampling rate at the gas meter for each sampling points before starting the test and record on the log the required rate (**Table-2**). Calculate the sampling rate at the gas meter as follows:

$$R_m = R_s \times \frac{T_m}{T_s} \times \frac{P_{\text{bar}} - P_s}{P_{\text{bar}} - P_m} \times \frac{V_m}{V_m + V_v}$$

Where

R_m = flow rate through meter, m³/s

R_s = Sampling rate at nozzle, LPM

T_m = Absolute temperature in metering condition, °K

T_s = Absolute stack gas temperature, °K

P_s = Absolute stack gas pressure, mm mercury column

P_{bar} = Barometer pressure, mm mercury column

P_m = $(P_{m1} - P_{m0}) / 2$ Suction at meter, mm mercury column

V_m = Volume of gas sampled at meter conditions, m³

V_v = Equivalent vapour volume of condensate at meter conditions, m³

Note: Take initial reading of vacuum guage (P_{m0}) in mm Hg at the starting of sampling and final vacuum pressure (P_{m1}) in mm Hg just before putting off the pump when sampling is complete. Calculate average difference in suction pressure, referred as P_m

- 5.3** Select the nozzle size, which provide a meter-sampling rate between 40 to 60 lit/min. Charts relating sampling rate with stack and meter condition may be prepared for the range of condition expected.

Duration of Sampling- Deem the run to be of sufficient length if one of the following criteria has been obtained:

- a) A minimum of 1 m³ of dry gas has been withdrawn for sampling.
- b) The mass of particulate matter amounts to atleast 20 percent of the mass of the filtering medium in the sampler.

Experience and intelligent judgment should be applied in determining the sampling time. Too short a time, may give unreliable result and too long a time may cause the resistance of the sampling train to exceed the pump's limits.

5.4 Preparation of the Sampling Train

- After proper nozzle and filtering medium have been selected assemble the sampling train as shown in **Figure 2**. Mark the sampling probe (including nozzle and filter holder) with the same traverse points used for conducting the velocity traverse.
- Place a clean, preweighted thimble/filter in the filter holder and tighten securely.
- Start the test after sampling rates have been calculated and train assembled & checked for leakages. When the equipment is ready in all respects, record the initial dry gas meter reading and push the sampling probe carefully into the duct to the point nearest to the back wall. This will allow the probe to cool in hot stack as it comes out, shortening the time required for cooling after the sample is taken. It is advisable to allow the nozzle and filter holder to preheat so that moisture present in the gases does not condense in the filter initial part of the sampling.
- When starting the test, the nozzle should be facing in the up stream direction, start operating the suction source, open the control valve and start the stop watch. Note the time and record it in the log sheet. Adjust the flow rate with the help of rotameter and control valve until the desired flow rate for isokinetic condition is obtained. As the test proceeds, dust collected in the thimble/ filter increases the amount of suction required to maintain proper meter rate. Valve should be adjusted accordingly. This suction should not exceed 150 mm of mercury for paper thimble/filter. In case it exceed this value before the completion of sampling, replace the same with a new thimble and restart sampling. During the test, if the mercury suction pressure at the meter drops suddenly it indicates that a leak has developed in the equipment or that thimble/filter has cracked. Record the initial gas meter reading and pressure and temperature in the sampling train as well as condensor temperature at half – minute's interval during the test.
- When sampling at one point has been completed, move the sampling probe to the next point as quickly as possible. At the completion of test, close the control valve, turn the direction of the probe so that the sampling nozzle is facing down-stream and record the final gas volume and time. Remove the sampler carefully from the flue and plug the nozzle to prevent the loss of sample.

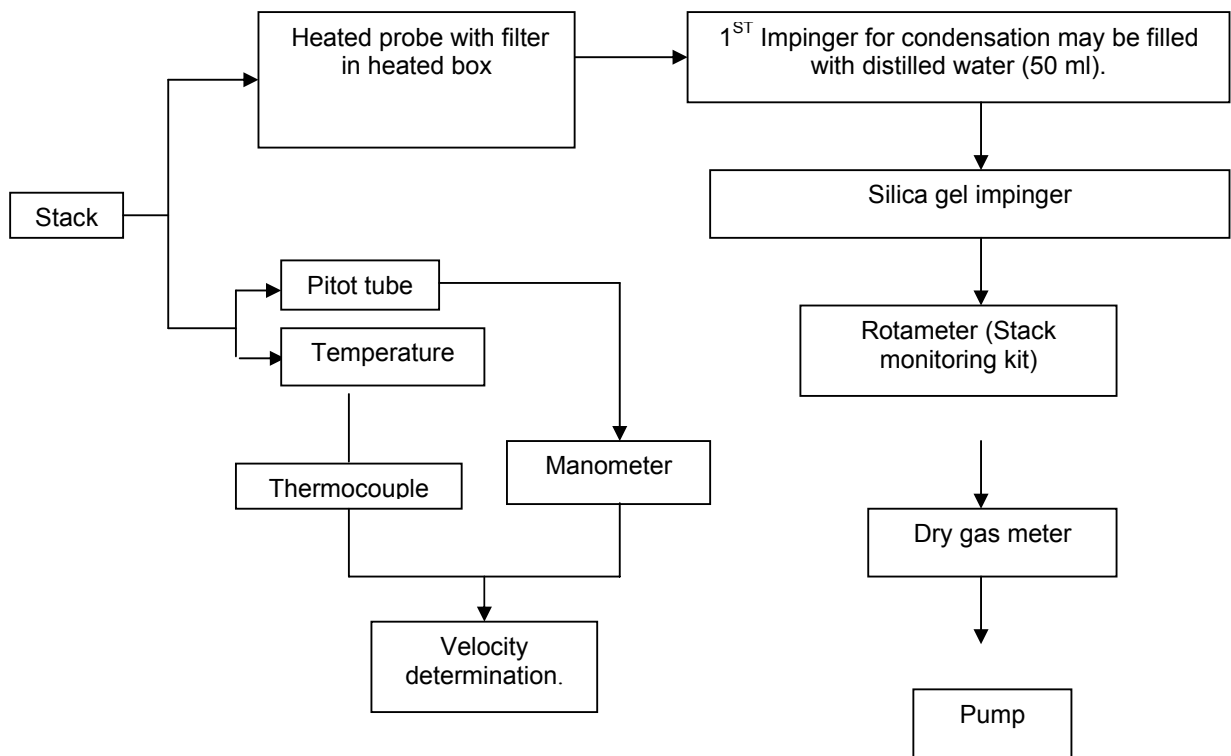

Fig 2: Sampling train for Particulate Matter

6.0 SAMPLE RECOVERY

After the sampler has cooled, brush down the dust on the inside of the nozzle carefully into the thimble using a small brush. Then, remove the thimble and place it in a dust tight container for transportation to the weighing room. In case the filter holder is kept outside during the sampling, the dust from the sampling probe before the filter holder should be brushed down into the filter.

- Determine the mass of dust collected in the thimble by difference in weighing, that is, by weighing the thimble before and after the run. Dry the thimble in an oven for about 2 hours at 120 °C prior to sampling. After sampling, cool it and dry again for weighing the thimble along with dust maintaining the same condition as prior to sampling.

7.0 CALCULATIONS

Calculate the volume of gas sampled using the following equation:

Volume of dry gas through the sampling train (25 °C 760 mm Hg)

$$V_{\text{std}} (\text{Nm}^3) = V_m Y \frac{P_{\text{bar}} - P_m}{760 \text{ mm Hg}} \times \frac{273 + 25 \text{ }^\circ\text{C}}{T_m + 273}$$

Where

T_m = Temperature of gas at dry meter condition, °C

V_m = Volume of gas sampled at dry gas meter conditions, m^3

$(P_{\text{bar}} - P_m)$ = Actual pressure in sampling train, mm mercury column.

P_m = Suction at meter, mm mercury column

P_{bar} = Barometric pressure in sampling train, mm mercury column.

Y = Calibration factor of dry gas meter.

7.1 Dust Concentration

Calculate the dust concentration using the following equation:

$$\text{Dust Concentration in mg /Nm}^3, \quad E_M = \frac{(W_2 - W_1) \text{ gm} \times 1000}{V_{\text{std}}}$$

(25 °C, 760 mm Hg, dry basis)

where

V_{std} = Volume of dry gas through the meter
(25 °C, 760 mm Hg), Nm^3

W_1 = Initial weight of filter paper

W_2 = Final weight of filter paper

7.2 Correction of the result at 11 % O₂

O₂ correction is only carried out, if O₂ corrections > 11%. For O₂ < 11% no correction is allowed.

It's require to correct the value for the 11% O₂ by following formula

$$E_S = \frac{21 - O_S}{21 - O_M} \times E_M$$

E_S = calculated emission concentration at the standard percentage oxygen concentration

E_M = measured emission concentration

O_S = standard oxygen concentration

O_M = measured oxygen concentration

7.3 Emission Rate

Calculate the dust emission rate as follows:

$$\text{Dust Emission Rate} = \frac{E_M \times Q_S}{10^6}$$

Where

Q_S = Flue gas flow rate (25 °C, 760 Hg mm Hg), Nm³ / hr.

All stack emission test results shall be given in dry basis as in 7.1 above, i.e. at zero percent moisture.

Note: Report the concentration as corrected at 11 % O₂

**Table- 2
Field Data Sheet**

Name & Address
Date & time of Sampling
Ambient Temperature °C
Barometric Pressure (mm mercury column)
Moisture in the flue gas (%) flue gas composition (CO₂ %, O₂ %, N₂)
Filter No and weight (Initial as well as Final)

Travers Point	Δ P (mm)	Ts (°K)	Ps	Us (m/s)	Qs (m ³ /hr)	Rs (LPM)	P _m		Rm (LPM)	Time (min)	DGM (m ³)		Vstd (Nm ³)
							P _{m0}	P _{m1}			Initial	Final	

Δ P = Stack Gas Velocity Pressure, (mm water column), Ts = Stack temperature (°K),
Ps= Static pressure (mm water column), Us = Velocity of stack gas (m/s),
Qs = Volumetric Flow Rate/ Discharge, Rs = Flow at nozzle (LPM),
P_m = Vacuum Pressure Drop (mm mercury column),
Rm = Determination of sampling rate at gas meter. (LPM),
Vstd = Determination of volume of Gas Sampled

Other required information:

- Feed rate of hazardous waste
- The nature, composition and quantity of the material being incinerated during monitoring
- Installed and operating capacity of the incinerator
- No of sampling ports
- Internal diameter of the stack
- Nozzle size selected for sampling
- Pitot tube constant
- ID fan capacity
- Pollution control equipment installed and its status
- House keeping

Signature of sample collector

Verified by

Approved by

**Occupier/
Representative of
the incinerator
facility**

8.0 REFERENCES

1. Comprehensive Industry Document Series, COINDS/ 20/ 1984 – 85, Central Pollution Control Board
2. EPA Method – 5.

CHAPTER- 2

STANDARD OPERATING PROCEDURE (SOP) FOR PARTICULATE MATTER DETERMINATION

Standard Operating Procedure for Particulate Matter Determination

1.0 Pre Sampling Activity

Weigh the properly conditioned thimble/filter and place it into the clean, air tight container. Designate appropriate label or ID No. to each thimble/filter container. Follow section 5.4 of part –II (Determination of particulate matter emission from stationary sources) of “Stack Monitoring – Material and Methodology for Isokinetic Sampling (method-1).”

Field activity starts with the collection of detail information’s from the industry about the products, raw materials, fuels, and stack dimensions.

2.0 Traverse Point Calculation

Calculate the traverse point and accordingly mark the distance from tip of the nozzle, on pitot tube and probe. Do not forget to add the collar length of port to the calculated traverses. For detail calculation see the section 1.3 of “Stack Monitoring – Material and Methodology for Isokinetic Sampling (Method-1).”

3.0 Composition of Flue Gas

Determine flue gas composition by orsat apparatus or multi gas analyzer. In case of Orsat analysis gas sample has to be collected in tedlar bag / non reactive bladder and allowed to cool before analysis. Gas analysis by multi gas analyser may be performed by direct insertion of sampling probe inside the stack and simultaneous estimation of all the components in pre-calibrated gas analyser. At least 3 observations should be taken for average percentile composition. Use gaseous composition data to calculate dry molecular weight of flue gas (M_d).

Determine the Dry molecular weight (M_d) by following equation

$$M_d = 0.44 (\%CO_2) + 0.32 (\% O_2) + 0.28(\% N_2 + \% CO) + \dots$$

4.0 Measure ambient temperature (°C) and Barometric pressure in mm Hg.

5.0 Check the Leak in Sampling Train

The sampling train after having set up will be tested for leakage by plugging the inlet. The rotameter shall not give a reading beyond 5 lpm when the flow has been set 100 lpm. Also the dry gas meter should give a reading of less than 5 percent of the air flow.

6.0 Moisture Determination

Moisture can be determined by condenser method , in principle, involves extracting a sample of the stack gases through a filter for removal of the particulate matter, then through a condenser accumulating the condensate formed in process, and finally through a gas meter. The objective of the test is to collect and measure the

volume of all the condensate formed at the condensing temperature from a measured amount of gas. For the detail see the section 1.2 of “Stack Monitoring – Material and Methodology for Isokinetic Sampling (Method-1).”

Calculations

Calculate equivalent vapour of condensate under sampling condition, m^3

$$V_v = \frac{(V_c \times 22.4)}{1000 \times 18} \times \frac{T_m}{273} \times \frac{760}{P_{bar} - P_m}$$

V_v = Equivalent vapour of condensate under sampling condition, m^3

V_c = Volume of condensate in condensor, ml

T_m = Absolute meter temperature, °K

P_m = Suction at meter, mm mercury column

P_{bar} = Barometer pressure, mm mercury column

Calculate the moisture content of the gases using the following equation:

$$B_{wo} = \frac{V_v}{V_v + V_m}$$

$$M = \frac{V_v}{V_v + V_m} \times 100$$

B_{wo} = Proportion by volume of water vapour in stack gas.

M = Moisture in the flue gases, percent

V_v = Equivalent vapour volume of condensate under sampling condition.

V_m = Volume of gas sampled (m^3)

7.0 Wet Molecular Weight (M_s) Determination:

This equation can be used to determine the molecular weight of the stack gas on a wet basis

$$M_s = M_d (1 - B_{wo}) + 18 B_{wo}$$

M_d = molecular weight of stack gas on dry basis, kg / kg –mole

8.0 Determine Stack Gas Velocity Pressure(ΔP) And Stack Temperature (T_s)

- Check and adjust the upper meniscus of manometer fluid at zero.
- Connect +ve and –ve end of the pitot tube in respective points.
- Slowly insert the pitot and thermocouple upto the first traverse mark inside the stack. Keep the positive end towards the direction from which flue is coming. Hold it for stabilisation. Take the reading of fluid displacement in manometer and temperature.
- Repeat the same in next traverse mark and so on.
- Take average reading for ΔP and T_s
- For measurement of static gas pressure pitot tube should be rotate by 90° from the position of actual ΔP measurement. This would provide better accuracy.

9.0 Determination Of Static Pressure (Absolute Stack Gas Pressure)

For the static pressure determination requires first to disconnect the positive end of the pitot tube then take the reading of velocity pressure at the traverse point in which the calculated average ΔP matches closely. For measurement of static gas pressure pitot tube should be rotated by 90° from the position of actual ΔP measurement. This would provide better accuracy

Calculate P_s

$$P_s = P_{\text{bar}} \pm (\Delta P_s / 13.6)$$

P_{bar} = Barometric pressure in mm mercury column

ΔP_s = Stack gas velocity pressure, mm water column

P_s = Static pressure mm Hg column.

Density of Hg = 13.6

10.0 Stack Gas Velocity Determination (U_s)

Connect pitot tube to the stack for velocity determination, calculate the stack gas velocity at all the traverse point by using the following formula. Consider the density factor for correction of velocity pressure and ΔP_s to convert water column manometer.

$$U_s = K_p C_p (\Delta P)^{1/2} \left[\frac{T_s}{(P_s \times M_s)} \right]^{1/2}$$

Where

Us = Stack gas velocity, m/s

Kp = Constant

Cp = S- type pitot tube coefficient.

Ts = absolute stack gas temperature, °K

ΔP = Stack gas velocity pressure, mm water column

Ps = Absolute stack gas pressure, mm Hg

Ms = Molecular weight of stack gas on wet basis, Kg / Kg –mole

11.0 Determination of Volumetric Flow Rate/ Discharge

The following equation is used to calculate stack gas volumetric flow rate (m³/hr).

$$Q_s = 3600 (U_s) \times A_s (1-B_{wo}) \times \left[\frac{T_{ref}}{T_s} \right] \left[\frac{P_s}{P_{ref}} \right]$$

As = Area of the stack (duct), m²

B_{wo} = Proportion by volume of water vapour in stack gas.

T_{ref} = 298 °K

P_{ref} = 760 mm

T_s = Absolute stack gas temperature, °K

P_s = Absolute stack gas pressure

12.0 Determination of Flow at Nozzle

Selecte the nozzle size, in such away that sampling rate a meter shall not exceed 70 % of pump capacity in any case. Cross sectional area of nozzle (mm) for different diameter is as follow

S No.	Dia of the nozzle (")	Cross sectional area (m ²)
1.	5/8	1.9783 × 10 ⁻⁰⁴
2.	3/4	2.8487 × 10 ⁻⁰⁴
3.	1/2	1.2661 × 10 ⁻⁰⁴
4.	1/4	3.16531 × 10 ⁻⁰⁵
5.	1/8	7.9132 × 10 ⁻⁰⁶

$$R_s = (U_s * A_n) * 60 * 1000 \text{ LPM}$$

Where,

R_s = Sampling Rate at nozzle, LPM

U_s = Stack gas velocity, m/sec

A_n = Area of nozzle, m^2

60 = Conversion Factor Seconds to Minute

1000 = Conversion Factor m^3 to Litre

13.0 Determination of Sampling Rate at the Gas Meter

The meter for measuring the gas sample measures the gas at conditions of temperature, pressure and moisture content which are different than those in the flue. Therefore, calculate the sampling rate at the gas meter for each sampling points before starting the test and record on the log the required rate (Table 1). Calculate the sampling rate at the gas meter as follows:

$$R_m = R_s \times \frac{T_m}{T_s} \times \frac{P_{bar} - P_s}{P_{bar} - P_m} \times \frac{V_m}{V_m + V_v}$$

R_m = Flow rate through meter, m^3/s

R_s = Sampling Rate at nozzle, LPM

T_m = Temperature at metering condition, $^{\circ}K$

T_s = Absolute stack gas temperature, $^{\circ}K$

P_s = Absolute stack gas pressure, mm mercury column

P_{bar} = Barometer pressure, mm mercury column

P_m = $(P_{m1} - P_{m0}) / 2$ Suction at meter, mm mercury column

V_m = Volume of gas sampled at meter conditions, m^3

V_v = Equivalent vapour volume of condensate at meter conditions, m^3

Note: Take initial reading of vacuum gauge (P_{m0}) in mm Hg at the starting of sampling and final vacuum pressure (P_{m1}) in mm Hg just before putting off the pump when sampling is complete. Calculate average difference in suction pressure, referred as P_m

14.0 Start the test after the sampling rate has been calculated and train assembled and checked for leakages. When equipment is ready in all respect, record the initial dry gas meter reading and push the sampling probe carefully into the duct to the point nearest to the back wall. Take the sample appropriately as per the requirement and with all the necessary precaution.

15.0 Determination of Volume of Gas Sampled

Calculate the volume of gas sampled using the following equation:

$$V_{std} = V_m \times Y \frac{P_{bar} - P_m}{760 \text{ mm Hg}} \times \frac{273 + 25 \text{ }^\circ\text{C}}{T_m + 273}$$

T_m = Temperature of gas at dry meter condition, °C

V_m = Volume of gas sampled at dry gas meter conditions, m³

(P_{bar} - P_m) = Actual pressure in sampling train, mm mercury column.

P_m = Static pressure in sampling train, mm mercury column

P_{bar} = Barometric pressure in sampling train, mm mercury column.

Y = Calibration factor of dry gas meter.

16.0 Sample Recovery

After the sampler has cooled, brush down the dust on the side of the nozzle carefully into the thimble using a small brush remove the thimble and replace it in same labeled container. In the case of filter holder is kept outside during the sampling, the dust from the sampling probe before the filter holder should be brushed down into the filter.

Note:

See the section 6.0 of part –II (Determination of particulate matter emission from stationary sources) of “Stack Monitoring – Material and Methodology for Isokinetic Sampling (method-1).”

17.0 Determination of Dust Concentration

Determine the mass of dust collected in the thimble by difference i.e weighing the thimble before and after the run. Dry the thimble in an oven for about 2 hours at 120 °C prior to sampling. After sampling, cool, dry and again weigh the thimble along with dust maintaining the same condition as prior to sampling.

Calculate the dust concentration using the following equation:

$$\text{Dust Concentration in mg /Nm}^3 \text{ (25 }^\circ\text{C, 760 mm Hg, dry basis)} \quad E_m = \frac{(W_2 - W_1) \text{ gram} \times 1000}{V_{\text{std}}}$$

V_{std} = Volume of dry gas through the meter, (25 °C, 760 mm Hg), Nm³

W_1 = Initial weight of filter paper

W_2 = Final weight of filter paper

18.0 Correction of the result at 11 % O₂

O₂ correction is only carried out, if O₂ corrections > 11%. For O₂ < 11% no correction is allowed.

It's require to correct the value for the 11% O₂ by following formula

$$E_s = \frac{21 - O_s}{21 - O_m} \times E_m$$

E_s = calculated emission concentration at the standard percentage oxygen concentration

E_m = measured emission concentration

O_s = standard oxygen concentration

O_m = measured oxygen concentration

19.0 Determination of Emission Rate

Calculate the dust emission rate as follows:

$$\text{Dust Emission Rate = (Kg/ hr)} = \frac{E_m \times Q_s}{10^6}$$

Q_s = Flue gas flow rate (25 °C, 760 Hg mm Hg), Nm³ / hr.

Note: Report the concentration as corrected at 11 % O₂

**Table- 1
Field Data Sheet**

Name & Address

Date & time of Sampling

Ambient Temperature °C

Barometric Pressure (mm mercury column)

Moisture in the flue gas (%) flue gas composition (CO₂ %, O₂ %, N₂)

Filter No and weight (Initial as well as Final)

Travers Point	Δ P (mm)	Ts (°K)	Ps	Us (m/s)	Qs (m ³ /hr)	Rs (LPM)	P _m		Rm (LPM)	Time (min)	DGM (m ³)		Vstd (Nm ³)
							P _{m0}	P _{m1}			Initial	Final	

Δ P = Stack Gas Velocity Pressure, (mm water column), Ts = Stack temperature (°K),
 Ps = Static pressure (mm water column), Us = Velocity of stack gas (m/s),
 Qs = Volumetric Flow Rate/ Discharge, Rs = Flow at nozzle (LPM),
 P_m = Vacuum Pressure Drop (mm mercury column),
 Rm = Determination of sampling rate at gas meter. (LPM),
 Vstd = Determination of volume of Gas Sampled

Other required information:

- Feed rate of hazardous waste
- The nature, composition and quantity of the material being incinerated during monitoring
- Installed and operating capacity of the incinerator
- No of sampling ports
- Internal diameter of the stack
- Nozzle size selected for sampling
- Pitot tube constant
- ID fan capacity
- Pollution control equipment installed and its status
- House keeping

Signature of sample collector

Verified by

Approved by

Occupier/
Representative of
the incinerator
facility

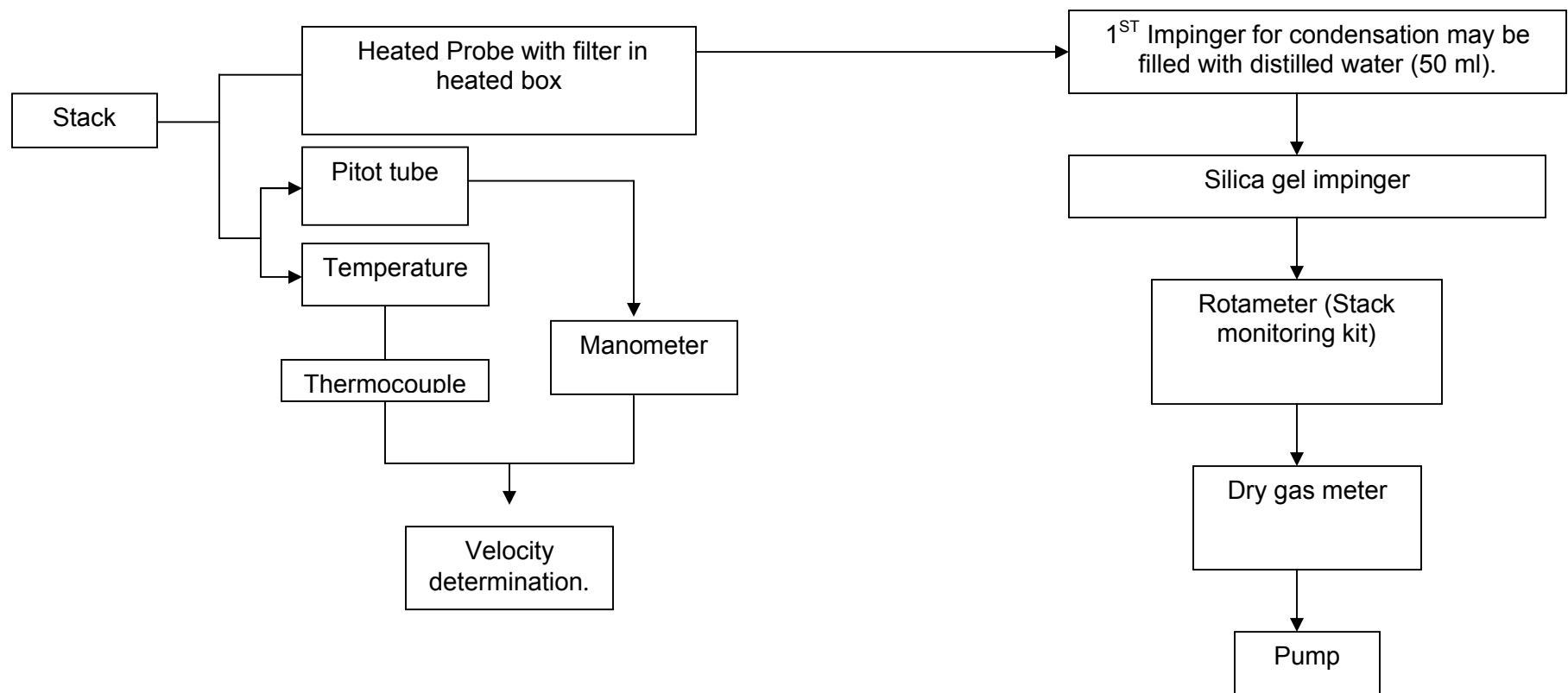

Fig - 1: Sampling train for Particulate Matter

CHAPTER- 3

DETERMINATION OF HYDROGEN HALIDES (HX) AND HALOGENS FROM SOURCE EMISSION.

**DETERMINATION OF HYDROGEN HALIDES (Hx) and HALOGENS IN
SOURCE EMISSION
(Part- i)**

1.0 PRINCIPLE

Gaseous and particulate pollutants are withdrawn isokinetically from the source and collected in an optional cyclone, preferably on a PTFE filter, and in absorbing solutions. The cyclone collects any liquid droplets and is not necessary if the source emissions do not contain them; however, it is preferable to include the cyclone in the sampling train to protect the filter from any moisture present. The filter collects other particulate matter including halide salts. Acidic and alkaline absorbing solutions collect the gaseous hydrogen halides and halogens, respectively. Following sampling for emissions containing liquid droplets, any halides/halogens dissolved in the liquid in the cyclone and on the filter are vaporized to gas and collected in the impingers by pulling conditioned ambient air through the sampling train. The hydrogen halides are solubilized in the acidic solution and form chloride (Cl^-), bromide (Br^-), and fluoride (F^-) ions. The halogens have a very low solubility in the acidic solution and pass through to the alkaline solution where they are hydrolyzed to form a proton (H^+), the halide ion, and the hypohalous acid (HClO or HBrO). Sodium thiosulfate is added in excess to the alkaline solution to assure reaction with the hypohalous acid to form a second halide ion such that two halide ions are formed for each molecule of halogen gas. The halide ions in the separate solutions are measured by ion chromatography (IC).

2.0 APPLICABILITY

This method is applicable for determining emissions of hydrogen halides (HX) [hydrogen chloride (HCl), hydrogen bromide (HBr), and hydrogen fluoride (HF)] and halogens [chlorine (Cl_2) and bromine (Br_2)] from stationary sources. Same method may be applicable for those sources, which are controlled by wet scrubbers and emit acid particulate matter. Due to corrosive nature of expected flue gas glass lined probe is recommended for this method.

2.1 Detection Limit

The in-stack detection limit is approximately 0.05 μg per liter of stack gas; the analytical detection limit is 0.1 $\mu\text{g}/\text{ml}$.

3.0 INTERFERENCES

Volatile materials, such as chlorine dioxide (ClO_2) and ammonium chloride (NH_4Cl), which produce halide ions upon dissolution during sampling, are potential interferents. Interferents for the halide measurements are the halogen gases which disproportionate to a hydrogen halide and a hydrohalous acid upon dissolution in water. However, the use of acidic rather than neutral or basic solutions for collection of the hydrogen halides greatly reduces the dissolution of any halogens passing through this solution. The simultaneous presence of HBr and Cl_2 may cause a positive bias in the HCl result with a corresponding negative bias in the Cl_2 result as well as affecting the HBr/Br split. High concentrations of

nitrogen oxides (NO_x) may produce sufficient nitrate (NO₃⁻) to interfere with measurements of very low Br⁻ levels.

4.0 REAGENTS

4.1 Sampling Reagents

Table 1: Sampling reagents

S. No	Reagents	Procedure for preparation
1	Deionized, distilled water	
2	0.1 N Sulfuric Acid (H ₂ SO ₄).	To prepare 100 ml of the absorbing solution for the front impinger pair, slowly add 0.28 ml of concentrated H ₂ SO ₄ to about 90 ml of water while stirring, and adjust the final volume to 100 ml using additional water. Shake well to mix the solution.
3	0.1 N Sodium Hydroxide (NaOH).	To prepare 100 ml of the alkaline absorbing solution for the fourth impinger, dissolve 0.40 g of solid NaOH in about 90 ml of water, and adjust the final solution volume to 100 ml using additional water. Shake well to mix the solution.
4	Sodium Thiosulfate (Na ₂ S ₂ O ₃ · 5H ₂ O) powder.	

4.2 Analytical Reagents

- Deionised / nano pure distilled water
- Absorbing Solution Blanks
- Stock Standard Solutions

5.0 SAMPLING

5.1 Preparation of Collection Train

Prepare the sampling train as follows:

Pour 50 ml of the acidic absorbing solution into each one of the first pair of impingers, and 50 ml of the alkaline absorbing solution into each one of the second pair of impingers. Connect the impingers in series with the knockout impinger first, if used, followed by the two impingers containing the acidic absorbing solution and the two impingers containing the alkaline absorbing solution. Place a fresh charge of silica gel, or equivalent, in the drying tube or impinger (after the one more empty impinger) at the end of the impinger train. Adjust the probe temperature and the temperature of the filter and the stopcock, i.e., the heated area in Figure – 1 to a temperature sufficient to prevent water condensation. This temperature should be at least 20 °C above the source temperature, but not greater than 120°C. The temperature should be monitored throughout run to ensure that the desired temperature is maintained.

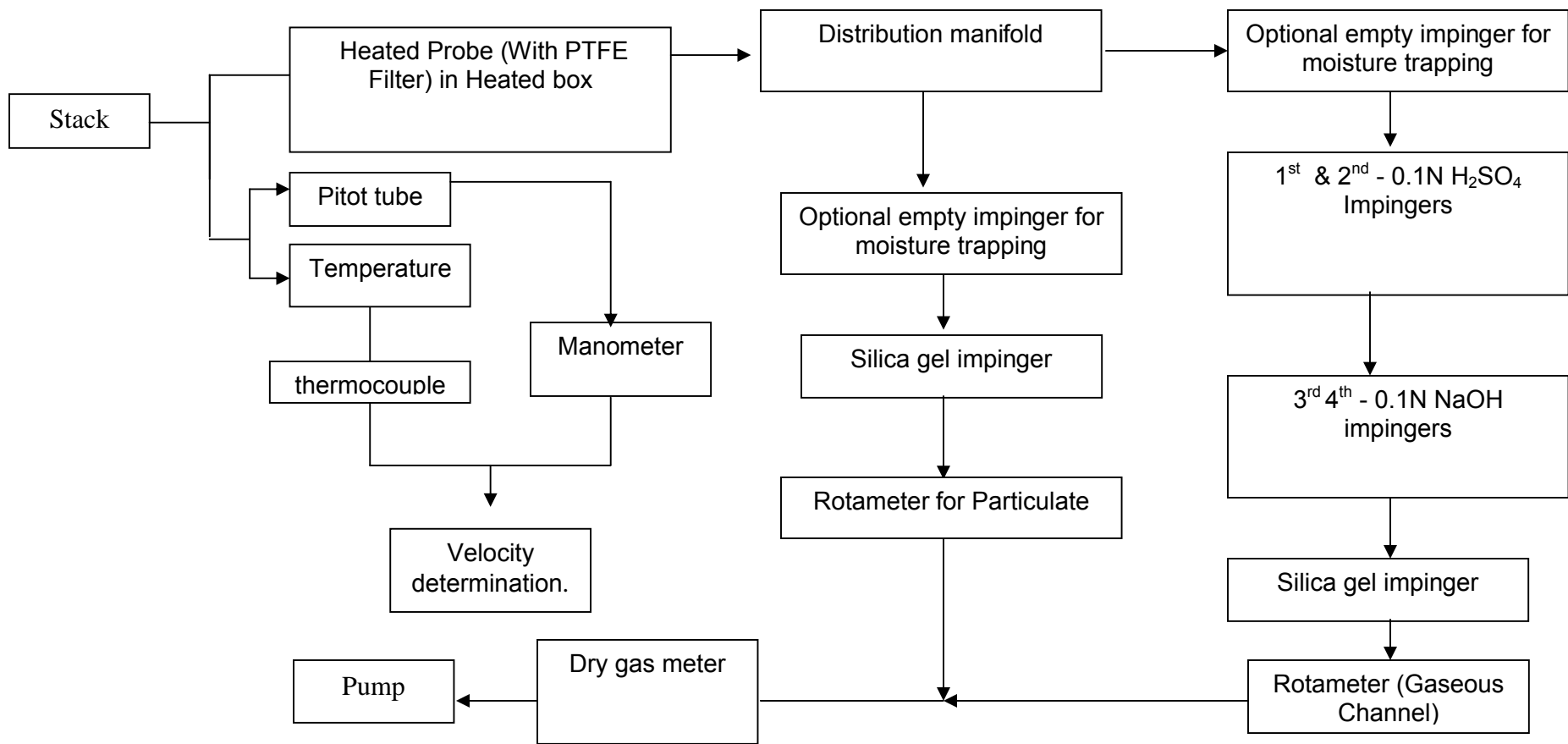

Fig - 1: Integrated Sampling train for particulate and gaseous H_x and Halogens

5.1.1 Leak-check procedure

The sampling train after having set up will be tested for leakage by plugging the inlet. The rotameter shall not give a reading beyond 5 lpm when the flow has been set 100 lpm. Also the dry gas meter should give a reading of less than 5 percent of the air flow.

5.1.2 Preliminary determinations and isokinetic sampling

Determine the stack pressure, temperature, leak check, calculation of Isokinetic velocity, volumetric flow rate, flow at nozzle/ selection of nozzle, adjustment of flow rate at rotameter, temperature at metering point and volume of gas sampled, pressure drop during sampling.

Note:

For the Calculation of isokinetic velocity and collection of the sample refer Method -1 "Stack monitoring – Material and Methodology for Isokinetic Sampling" or SOP for the particulate matter determination.

5.1.3 Sample collection

Turn on the vacuum pump and make a slight vacuum of 25 mm Hg (1 in. Hg). Set the sampling rate in gaseous train at 2 LPM & allow rest of the flow for isokinetic sampling rate in particulate train and maintain this rate to within 10 percent during the entire sampling run. Take readings of the dry gas meter volume and temperature, rate meter, and vacuum gauge at least once every five minutes during the run. A sampling time of one hour is recommended. Shorter sampling times may introduce a significant negative bias in the HCl concentration. During calculation of volume of air passes through the impinger & filter should be done by adding both the flow rate multiplied by sampling time. At the conclusion of the sampling run, remove the train from the stack and cool it.

5.2 Sample Recovery

Collect filter separately. No heating should be done in conditioning of filter preferably desiccation or use of conditioning room is suggested for Pre-conditioning and post-conditioning of filter. Disconnect the impingers after sampling. Quantitatively transfer the contents of the acid impingers and the knockout impinger, if used, to a leak-free storage bottle. Add the water rinses of each of these impingers and connecting glassware to the storage bottle. Quantity rinsing water should not be used more than 25ml. Repeat this procedure for the alkaline impingers and connecting glassware using a separate storage bottle. Add 25 mg sodium thiosulfate to ensure complete reaction with the hypohalous acid to form a second Cl^- ion in the alkaline solution. Save portions of the absorbing reagents (0.1 NH_2SO_4 and 0.1 N NaOH) equivalent to the amount used in the sampling train dilute to the approximate volume of the corresponding samples using rinse water directly from the wash bottle being used. Add the same (25 mg) amount of sodium thiosulfate solution to the 0.1 N NaOH absorbing solution blank. Also, save a portion of the rinse water used to rinse the sampling train. Place each in a separate, pre-labeled storage bottle. The sample storage bottles should be sealed, shaken to mix, and labeled. Mark the fluid level.

5.3 Sample Preparation for Analysis

Note the liquid levels in the storage bottles and confirm on the analysis sheet whether or not leakage occurred during transport. If major leakage is observed make up with DI water upto the marked level. Quantitatively (the whole sample or aliquot) transfer the sample solutions to 100-ml volumetric flasks, and dilute to 100 ml with water.

For acid mists extract the ions from thimble with 50 ml distilled water under ultrasonic bath at 60 °C for 1 hour.

6.0 SAMPLE ANALYSIS

All the samples extracted mists and impingers (first 2 – acidic and last two – alkaline) should be analysed separately for target ions.

Analysis of the acid and alkaline absorbing solution samples requires separate standard calibration curves if test run does not conform proper separation and baseline artifacts.

Ensure adequate baseline separation of the analyses. Before sample analysis, establish a stable baseline. Next, inject a sample of water, and determine if any Cl^- , Br^- , or F^- appears in the chromatogram. If any of these ions are present, repeat the load/injection procedure until they are no longer present.

Between injections of the appropriate series of calibration standards, reagent blanks, quality control sample, and the field samples should be injected. Duplicate injections are recommended and use the mean response to determine the concentrations of the field samples and reagent blanks using the linear calibration curve (forced through zero or linear quadratic). The values from duplicate injections should agree within 5 percent of their mean for the analysis to be valid. Dilute any sample and the blank with equal volumes of water if the concentration exceeds that of the highest standard.

7.0 CALCULATIONS

Retain at least one extra decimal figure beyond those contained in the available data in intermediate calculations, and round off only the final answer appropriately. As the individual analysis is performed for mist, acidic sample and alkaline sample in this method, individually calculated concentrations should be sum up to report final concentration of target analytes in flue gas. The formulae for individual calculation are stated below.

7.1 Sample Volume, Dry Basis, Corrected to Standard Conditions

$$V_{\text{mstd}} = V_m Y \left[\frac{T_{\text{std}}}{T_m} \right] \left[\frac{P_{\text{bar}}}{P_{\text{std}}} \right] = K_1 Y V_m \left[\frac{P_{\text{bar}}}{T_m} \right]$$

Where:

$K_1 = 0.3858 \text{ }^\circ\text{K/mm Hg}$ for metric units,
 $= 17.64 \text{ }^\circ\text{C/in. Hg}$ for English units

P_{bar} = Barometric pressure at the exit orifice of the DGM, mm Hg (in. Hg).

P_{std} = Standard absolute pressure, 760 mm Hg (29.92 in. Hg).

T_m = Average DGM absolute temperature, $^\circ\text{K}$ ($^\circ\text{C}$).

T_{std} = Standard absolute temperature, 293 $^\circ\text{K}$

Y = Dry gas meter calibration factor

$V_{\text{m(std)}}$ = Dry gas volume measured by the dry gas meter, corrected to standard conditions, Nm^3

V_m = {Sampling rate in gas channel (LPM) X duration (Minutes)} / 1000 m^3 .

**Table- 1
Field Data Sheet**

Name & Address
Date & time of Sampling
Ambient Temperature °C
Barometric Pressure (mm mercury column)
Moisture in the flue gas (%) flue gas composition (CO₂ %, O₂ %, N₂)
Filter No and weight (Initial as well as Final)

Travers Point	Δ P (mm)	Ts (°K)	Ps	Us (m/s)	Qs (m ³ /hr)	Rs (LPM)	P _m		Rm (LPM)	Time (min)	DGM (m ³)		Vstd (Nm ³)
							P _{m0}	P _{m1}			Initial	Final	

Δ P = Stack Gas Velocity Pressure, (mm water column), Ts = Stack temperature (°K),
Ps= Static pressure (mm water column), Us = Velocity of stack gas (m/s),
Qs = Volumetric Flow Rate/ Discharge, Rs = Flow at nozzle (LPM),
P_m = Vacuum Pressure Drop (mm mercury column),
Rm = Determination of sampling rate at gas meter. (LPM),
Vstd = Determination of volume of Gas Sampled

Other required information:

- Feed rate of hazardous waste
- The nature, composition and quantity of the material being incinerated during monitoring
- Installed and operating capacity of the incinerator
- No of sampling ports
- Internal diameter of the stack
- Nozzle size selected for sampling
- Pitot tube constant
- ID fan capacity
- Pollution control equipment installed and its status
- House keeping

Signature of sample collector

Verified by

Approved by

**Occupier/
Representative of
the incinerator
facility**

Analysis of Hx and Halogens (Part – ii)

1.0 PURPOSE AND APPLICABILITY

This document outlines procedures for the filter preparation and extraction, and the subsequent determination of anions in filter extracts.

2.0 SUMMARY OF METHOD

Teflon filters for collection of anions do not require pretreatment. Exposed filter samples are extracted by a method appropriate for the analyte(s) of interest. Filters are extracted with deionized water. Extraction with deionized water makes it possible to analyze for both anions and cations. Sample extracts are passed through a column of ion chromatographic resin consisting of polymer beads coated with quaternary ammonium active sites. During passage through the column, anion separation occurs due to the different affinities of the anions for the active resin sites. Following separation, the anions pass through a suppressor column which exchanges all cations for H⁺ ions. An eluent, which yields a low conducting acid, is used. Species are detected and quantified as their acids (e.g., HCl) by a conductivity meter.

3.0 INTERFERENCES

Large amounts of anions eluting close to the ions of interest will result in an interference. No interferences have been observed in Teflon/nylon filters samples analyzed to date. If interferences are observed, several steps to increase separation can be taken, such as reducing eluent strength and/or flow rate or replacing the columns.

4.0 APPARATUS AND MATERIALS

- Filters (Teflon/Nylon)
- Volumetric flask, 1000 mL, 500 mL, 250 mL, 100 mL and 50 mL
- Tweezers
- Glass rod drying racks
- Tweezers
- Adjustable Eppendorf or equivalent micro-pipettes
- Ultrasonic bath
- Syringe filter with 13 mm Nylon filter holder and filter discs
- 250 mL glass beakers

- Reagents

Stock Standards:- Use high purity graded chemicals for the preparation of all solutions. Dry chemicals used for the preparation of calibration standards at 105 °C for 2 hours and cool in a desiccator immediately before weighing. The stock solutions containing (anion) = 1000 mg/L can also be prepared by dissolving the appropriate amount of a suitable salt (purity standard.) in ultrapure water. The sample weight required per litre ultrapure water is shown in the Table 1. To

prepare the anion standard, these stock solutions are then diluted to the desired concentrations with ultrapure water.

Table 1: Required weight of salts to prepare 1000 ppm stock individual standards

Anions	Salt	Weights in (g)	Final Volume	Concentrations
Fluoride	NaF	2.2100	1000 mL	1000 mg/L
Chloride	NaCl	1.6484	1000 mL	1000 mg/L
Bromide	NaBr	1.4998	1000 mL	1000 mg/L

Commercially available high purity individual liquid stock standards (1000 ppm) are also useful. Mix standards should be chosen carefully considering the difference in responses of individual ions in a chromatogram.

Calibration Standards preparation:

Prepare Standard Mix - A solution containing 100 ppm each Cl⁻, from 1000 ppm stock by diluting the same.

Prepared Standard Mix – B solution containing F⁻ (5 ppm) and 20 ppm Br by diluting the respective stock. Final calibration standards for 6 levels are prepared following the Table given 2. Prepare fresh working calibration standards weekly and refrigerate when not in use. Stock Standards may be used for 6 months if refrigerated properly.

Table 2: Calibration Standards preparation guidelines (Final volume 100 ml)

Ions	Level I	Level II	Level III	Level IV	Level V	Level VI
	0.5ml A + 0.5 mL B	1 ml A + 1 mL B	2 ml A + 2 mL B	5 ml A + 5 mL B	10 ml A + 10 mL B	15 ml A + 15 mL B
Fluoride	0.025	0.05	0.1	0.25	0.5	1.0
Chloride	0.5	1.0	2.0	5.0	10.0	15.0
Bromide	0.1	0.2	0.4	1.0	2.0	3.0

Eluent: Specific for brand and make to instrument and columns being used. For concentration and composition of eluent please refer to the application notes. Generally for anion analysis NaHCO₃ - Na₂CO₃ eluent is used. Eluents are prepared by dissolving prescribed amount of chemicals in high purity nano-pure distilled water. Eluents are required to be filtered through 0.22 µm nylon filter.

Suppressor: Dionex system has inbuilt ionic suppressor system but Metrohm system chemical suppression for anions with 2.8 mL concentrated (98%) pure H₂SO₄ diluted in 1 litre is used for regeneration of suppressor cartridges. Pure water (DI) is used for washing of suppressor during run.

5.0 SAMPLE HANDLING

Laboratory shall provide chain-of-custody documentation with all sample shipments to track and ensure that filter samples are collected, transferred, stored, and analyzed by authorized personnel; sample integrity is maintained during all phases of sample handling and analysis; and an accurate written record is maintained of sample handling and treatment from the time of its collection, through the

laboratory analytical process, to the eventual relinquishing of all data to the project co-ordinator.

- Filter / Thimble Extraction Procedure

Filters to be analyzed for halides are extracted with water. Extraction with deionized water makes it possible to analyze for these ions.

- Remove filters to be extracted from the freezer and allow them to equilibrate to room temperature.
- Using gloved hands and tweezers, place each filter in cleaned glass beakers (250mL) that has been labeled with the sample I.D.
- Add measured 50-100 mL of deionized water. The extraction volume will depend upon the quantity of dust accumulated on filter paper.
- Place the batch of beakers in ultrasonic bath, expose them to ultrasonic energy in a bath for 60 minutes at 60 °C, and then allow them to sit at room temperature overnight. Refrigerate at least one additional night prior to analysis.
- Record the date of extraction on the Sample Filter Processing Form. Allow the samples to warm to room temperature just prior to analysis.
- Filter all the samples by syringe filter using 13 mm 6.6 µm nylon filter disc. Ensure no particle should pass through in samples to be injected. Injection may be done manually or through autosampler.

- The liquid sample (alkaline and acidic) analysis

The alkaline and acidic samples are injected separately in IC system and analysed for all the three halides.

Note: Different calibration curve for acidic and alkaline analysis may be required to get better baseline separation in IC system. In this case separate set of calibration Standards in two different absorbing media shall be prepared.

- IC Procedure:

- Fill the eluent reservoirs with the eluent.
- Fill the suppressor reservoir and distilled water reservoir in case of chemical suppression technique (Metrohm instrument)
- Start the eluent flow, activate the self-regenerating suppressor in case of (Dionex instrument), and allow the baseline to stabilize.
- In case of Metrohm instrument ensure that all the three suppressor cartridge are recharged. Start baseline determination wait until stable baseline is achieved.
- Inject two pure distilled water blanks to flush the system and to ensure that the system is operating properly.
- Using the calibration schedule, perform the monthly multipoint calibration over the range.
- Inject middle level calibration standards daily to know the status of performance. If the observed value for any ion differs by more than 10 percent from the known values, identify and correct the problem before analyzing samples.
- Load the sample extracts into the autosampler vials according to the schedule prepared for that day. Typically, fifty field samples are analyzed

per day. The daily schedule includes, at a minimum, 3 duplicate samples, 2 spiked samples and 5 QA/QC samples.

- ix) Begin the analysis run, occasionally checking to ensure that the system is operating properly.
- x) Examine the data at the end of the run. If the concentration of any ion exceeds the upper end of the calibration curve, dilute the sample appropriately and include with the samples to be analyzed the following day.

6.0 CALCULATIONS AND DATA REDUCTION

In-built software will always give some results, which may not be acceptable all the time. Study each and every chromatogram and perform manual integration of peaks if necessary. Proceed to report format and copy the results in Excel data sheet.

6.1 Total μg HCl, HBr, or HF Per Sample

$$m_{\text{HX}} = K (V_s) (S_x - B_x)$$

Where

m_{HX} = Mass of HCl, HBr, or HF in sample, μg .

B_x = Mass concentration of applicable absorbing solution blank, μg halide ion (Cl^- , Br^- , F^-)/ml, not to exceed 1 $\mu\text{g}/\text{ml}$ which is 10 times the published analytical detection limit of 0.1 $\mu\text{g}/\text{ml}$.

S_x = Analysis of sample, μg halide ion (Cl^- , Br^- , F^-)/ml

V_s = Volume of filtered and diluted sample, ml.

$K_{\text{HCl}} = 1.028 (\mu\text{g HCl}/\mu\text{g-mole})/(\mu\text{g Cl}^-/\mu\text{g-mole})$.

$K_{\text{HBr}} = 1.013 (\mu\text{g HBr}/\mu\text{g-mole})/(\mu\text{g Br}^-/\mu\text{g-mole})$.

$K_{\text{HF}} = 1.053 (\mu\text{g HF}/\mu\text{g-mole})/(\mu\text{g F}^-/\mu\text{g-mole})$.

6.2 Total μg Cl^- , Br^- , F^- Per Sample

$$M_{\text{X}_2} = V_s (S_x - B_x)$$

Where

M_{X_2} = Mass of Cl^- , Br^- or in sample, μg .

B_x = Mass concentration of applicable absorbing solution blank, μg halide ion (Cl^- , Br^- , F^-)/ml, not to exceed 1 $\mu\text{g}/\text{ml}$ which is 10 times the published analytical detection limit of 0.1 $\mu\text{g}/\text{ml}$.

S_x = Analysis of sample, μg halide ion (Cl^- , Br^- , F^-)/ml

V_s = Volume of filtered and diluted sample, ml.

Calculated values for all the aliquots (Thimble, Alkaline trap and acidic trap) are sum up and the total mass is divided by standardised Air volume to get respective concentrations in mg/Nm^3 .

Hence, for F, Cl_2 or Br_2

$$C_x = \left[\{m_{X_2 (\text{Thimble})} + m_{X_2 (\text{Alkaline trap})} + m_{X_2 (\text{Acidic Trap})} \} * 10^{-3} \right] / V_{m(\text{std})} \text{ mg}/\text{Nm}^3$$

Where,

- C_x = Concentration of Cl^- , Br^- , F^- in Flue gas
- m_{X_2} = Mass of Cl, Br, or in sample (μg) in respective aliquot.
- $V_{m(\text{std})}$ = Dry gas volume measured by the DGM, corrected to standard conditions, Nm^3

Hence, for HCl , HBr , or HF

$$C_{\text{HX}} = \left[\{m_{\text{HX} (\text{Thimble})} + m_{\text{HX} (\text{Alkaline trap})} + m_{\text{HX} (\text{Acidic Trap})} \} * 10^{-3} \right] / V_{m(\text{std})} \text{ mg}/\text{Nm}^3$$

Where,

- C_{HX} = Concentration of HCl , HBr or HF in flue gas.
- m_{HX} = Mass of HCl , HBr or HF in sample (μg) in respective aliquot.
- $V_{m(\text{std})}$ = Dry gas volume measured by the DGM, corrected to standard conditions, Nm^3

Note: Report the concentration as corrected at 11% O_2 (as mentioned in the method for PM determination)

7.0 QUALITY ASSURANCE AND QUALITY CONTROL

The analyst should be familiar with the terms and use of following parameters for QA/QC

- Blank: a sample that has not been exposed to the analyzed sample stream in order to monitor contamination during sampling, transport, storage or analysis. The blank is subjected to the usual analytical and measurement process to establish a zero baseline or background value and is sometimes used to adjust or correct routine analytical results.
- Field Blanks: These are filters that are treated in all ways as a normal sample (including installation on the sampler) except that no air is sampled on them. (These are also referred to as equipment blanks in LIMS.)
- Continuing Calibration Blank (CCB): a “zero” standard analyzed along with the CCV standard to verify that the lower end of the calibration curve remains valid during the analysis of the batch of samples. A CCB is analyzed at the beginning of each batch, at the end of a batch, and at least every 20 samples during a batch.
- Continuing Calibration Verification Standard (CCV): a standard analyzed after the initial calibration to verify that the instrument calibration remains valid. The concentration of this standard is varied over the calibration range during each run. A CCV is analyzed at the beginning of each batch, at the end of a batch, and at least every 20 samples during a batch.

- **Laboratory Duplicate:** aliquots of a sample taken from the same container under laboratory conditions and processed and analyzed independently. In this SOP, laboratory duplicates are created by extracting equal portions of the loaded filters.
- **Matrix Spike (spiked sample or fortified sample):** a sample prepared by adding a known mass of target analyte to a specified amount of matrix sample for which an independent estimate of Target analyte concentration is available. Matrix spikes are used, for example, to determine the effect of the matrix on a method's recovery efficiency. In this SOP, a matrix spike consists of adding a known concentration of analyte(s) to a separate aliquot of the filter.
- **Method Detection Limit (MDL):** the minimum concentration of an analyte that can be identified,
- measured, and reported with 99% confidence that the analyte concentration is greater than zero.
- **Method Reporting Limit (MRL):** the minimum concentration of an analyte that is reported. Generally, this will be 3 to 5 times the concentration of the MDL.

If correlation coefficient for all the multipoint calibration curves does not exceed 0.998, stop the analysis and identify the problem.

Analyze QC samples at the beginning of every analytical run. Compare the results with those obtained during previous QC tests. If the observed concentration of any ion differs from the known value by greater than 10%, stop the analysis until the problem is identified and corrected. Analyze a duplicate sample, a QA/QC sample, and a spiked sample after at least every 20 field samples.

8.0 REFERENCES

1. DRI Document No. 8068.1F4, Appendix D, Section 4.2
2. Steinsberger, S. C. and J. H. Margeson, "Laboratory and Field Evaluation of a Methodology for Determination of Hydrogen Chloride Emissions from Municipal and Hazardous Waste Incinerators," U.S. Environmental Protection Agency, Office of Research and Development, Report No. 600/3- 89/064, April 1989. Available from the National Technical Information Service, Springfield, VA 22161 as PB89220586/AS.
3. State of California, Air Resources Board, Method 421, "Determination of Hydrochloric Acid Emissions from Stationary Sources," March 18, 1987. 3. Cheney, J.L. and C.R. Fortune. Improvements in the Methodology for Measuring Hydrochloric Acid in Combustion Source Emissions. *J. Environ. Sci. Health.* A19(3): 337-350. 1984.
4. Stern, D. A., B. M. Myatt, J. F. Lachowski, and K. T. McGregor. Speciation of Halogen and Hydrogen Halide Compounds in Gaseous Emissions. In: *Incineration and Treatment of Hazardous Waste: Proceedings of the 9th Annual Research Symposium*, Cincinnati, Ohio, May 2-4, 1983. Publication No. 600/9-84-015. July 1984. Available from National Technical Information Service, Springfield, VA 22161 as PB84-234525.
5. Holm, R. D. and S. A. Barksdale. Analysis of Anions in Combustion Products. In: *Ion Chromatographic Analysis of Environmental Pollutants*. E. Sawicki, J. D. Mulik, and E. Wittgenstein (eds.). Ann Arbor, Michigan, AnnArbor Science Publishers. 1978. pp. 99-110.
6. Steinsberger, S. C. and J. H. Margeson. Laboratory and Field Evaluation of a Methodology for Determination of Hydrogen Chloride Emissions from Municipal and Hazardous Waste Incinerators. U.S. Environmental Protection Agency, Office of Research and Development. Publication No. 600/3-89/064. April 1989. Available from National Technical Information Service, Springfield, VA 22161 as PB89220586/AS.
7. State of California Air Resources Board. Method 421 - Determination of Hydrochloric Acid Emissions from Stationary Sources. March 18, 1987.
9. Cheney, J.L. and C.R. Fortune. Improvements in the Methodology for Measuring Hydrochloric Acid in Combustion Source Emissions. *J. Environ. Sci. Health.* A19(3): 337-350. 1984.
- 10 Stern, D.A., B.M. Myatt, J.F. Lachowski, and K.T. McGregor. Speciation of Halogen and Hydrogen Halide Compounds in Gaseous Emissions. In: *Incineration and Treatment of Hazardous Waste: Proceedings of the 9th Annual Research Symposium*, Cincinnati, Ohio, May 2-4, 1983. Publication No. 600/9-84-015. July 1984. Available from National Technical Information Service, Springfield, VA 22161 as PB84-234525.

11. Holm, R.D. and S.A. Barksdale. Analysis of Anions in Combustion Products. In: Ion Chromatographic Analysis of Environmental Pollutants, E. Sawicki, J.D. Mulik, and E. Wittgenstein (eds.). Ann Arbor, Michigan, Ann Arbor Science Publishers. 1978. pp. 99-110.

CHAPTER- 4

STANDARD OPERATING PROCEDURE FOR THE SAMPLING OF HYDROGEN HALIDES AND HALOGENS FROM SOURCE EMISSION

Standard Operating Procedure for the Sampling of Hydrogen Halides (Hx) and Halogens from Source Emission

1.0 Purpose and Applicability

This method is applicable for determining emissions of hydrogen halides (HX) and halogens from stationary sources. Same method may be applicable for those sources, which are controlled by wet scrubbers and emit acidic particulate matter.

1.1 Detection Limit

The in-stack detection limit is approximately 0.05 µg/liter of stack gas; the analytical detection limit is 0.1 µg/ml.

2.0 Pre sampling activity

- Rinse all sampling train glassware with hot tap water and then wash in hot soapy water.
- Rinse glassware three times with tap water, followed by three additional rinses with distilled water.
- Soak all glassware in a 10 percent (V/V) nitric acid solution for a minimum of 4 hours, later rinse three times with distilled water, rinse finally with acetone, and allow to air dry.
- Cover all glassware openings where contamination can occur until the sampling train is assembled for sampling.

3.0 Preparation of Reagents

3.1 Sampling Reagent

- Deionized, distilled water
- Sulfuric Acid (H₂SO₄) (0.1 N)
Add 0.28 ml of concentrated H₂SO₄ to 90 ml of distilled water while stirring. Make final volume upto 100 ml for front impinger pair.
- Sodium Hydroxide (NaOH) (0.1 N)
Dissolve 0.40 g of solid NaOH in 90 ml of water and make final volume up to 100 ml for third and fourth impinger.
- Sodium Thiosulfate (Na₂S₂O₃ .5H₂O) powder.

3.2 Analytical Reagents

- Deionised / nano pure distilled water
- Absorbing Solution Blanks
- Stock Standard Solutions

Field activities start with the collection of details information from the industry about products, materials, fuel and stack.

4.0 Field Activities and Isokinetic Sampling

Determine the stack pressure, temperature, leak check, calculation of Isokinetic velocity, volumetric flow rate, flow at nozzle/ selection of nozzle, adjustment of flow rate at rotameter, temperature at metering point and volume of gas sampled, pressure drop during sampling as described in the SOP of the particulate matter.

Note:

For the Calculation of isokinetic velocity and collection of the sample refer Method -1 "Stack monitoring – Material and Methodology for Isokinetic Sampling" or SOP for the particulate matter determination

5.0 Prepare the Sampling Train as Follows

- Pour 50 ml of the acidic absorbing solution into each one of the first pair of impingers
- Pour 50 ml of the alkaline absorbing solution into each one of the second pair of impingers
- Connect the impinger in series with empty knockout impinger first if used (See Figure 1)
- Place a fresh charge of silica gel, or equivalent, in the drying tube or impinger (after the one more optional empty impinger) at the end of the impinger train.
- Adjust the probe temperature and the temperature of the filter and the stopcock temperature sufficient to prevent water condensation. Temperature should be at least 20 °C above the source temperature, but not greater than 120°C. The temperature should be monitored to ensure that the desired temperature is maintained.

6.0 Sample Collection

- Turn on the vacuum pump and make a slight vacuum of 25 mm Hg (1 in. Hg). Set the sampling rate in gaseous train at 2 LPM & allow rest of the flow for isokinetic sampling rate in particulate train.
- Take readings of the dry gas meter volume and temperature, rotameter, and vacuum gauge at least once every five minutes during the run.
- Sampling should be carried out for 1 hr or for the duration sufficient to collect samples to be detected above detection limit.
- During calculation of volume of air passes through the impinger & filter should be done by adding both the flow rate multiplied by sampling time.
- At the completion of sampling remove the train from the stack and cool it.

7.0 Sample Recovery

- Collect filter separately. No heating should be done in conditioning of filter preferably desiccation or use of conditioning room is suggested.
- Disconnect the impingers; quantitatively transfer the contents of the acid impingers and the first empty impinger, if used, to a leak-free storage bottle.
- Add the water rinses of each of these impingers and connecting glassware to the storage bottle. Quantity of rinsing should not be used more than 25ml.
- Repeat this procedure for the alkaline impingers and connecting glassware using a separate storage bottle. Quantity of rinsing water should not be used more than 25ml.
- Add 25 mg sodium thiosulfate to ensure complete reaction with the hypohalous acid to form second Cl^- ion in the alkaline solution.
- Save portions of the absorbing reagents (0.1 NH_2SO_4 and 0.1 N NaOH) equivalent to the amount used in the sampling train dilute to the approximate volume of the corresponding samples using rinse water directly from the wash bottle being used. Add the same (25mg) amount of sodium thiosulfate solution to the 0.1 N NaOH absorbing solution blank.
- Also, save a portion of the rinse water used to rinse the sampling train. Place each in a separate, prelabeled storage bottle. The sample storage bottles should be sealed, shaken to mix, and labeled. Mark the fluid level.

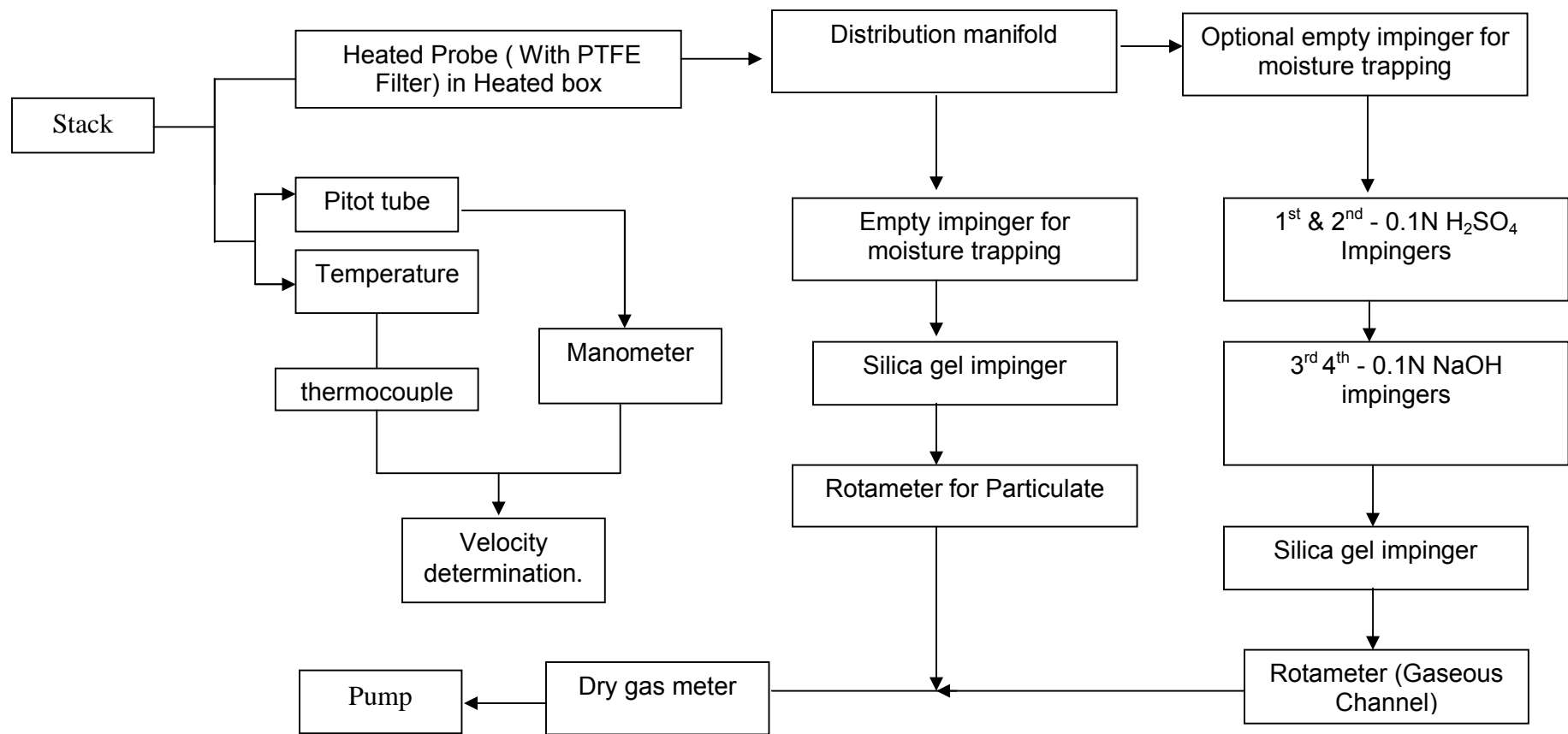

Fig 1: Integrated sampling train for particulate and gaseous H_x and Halogens

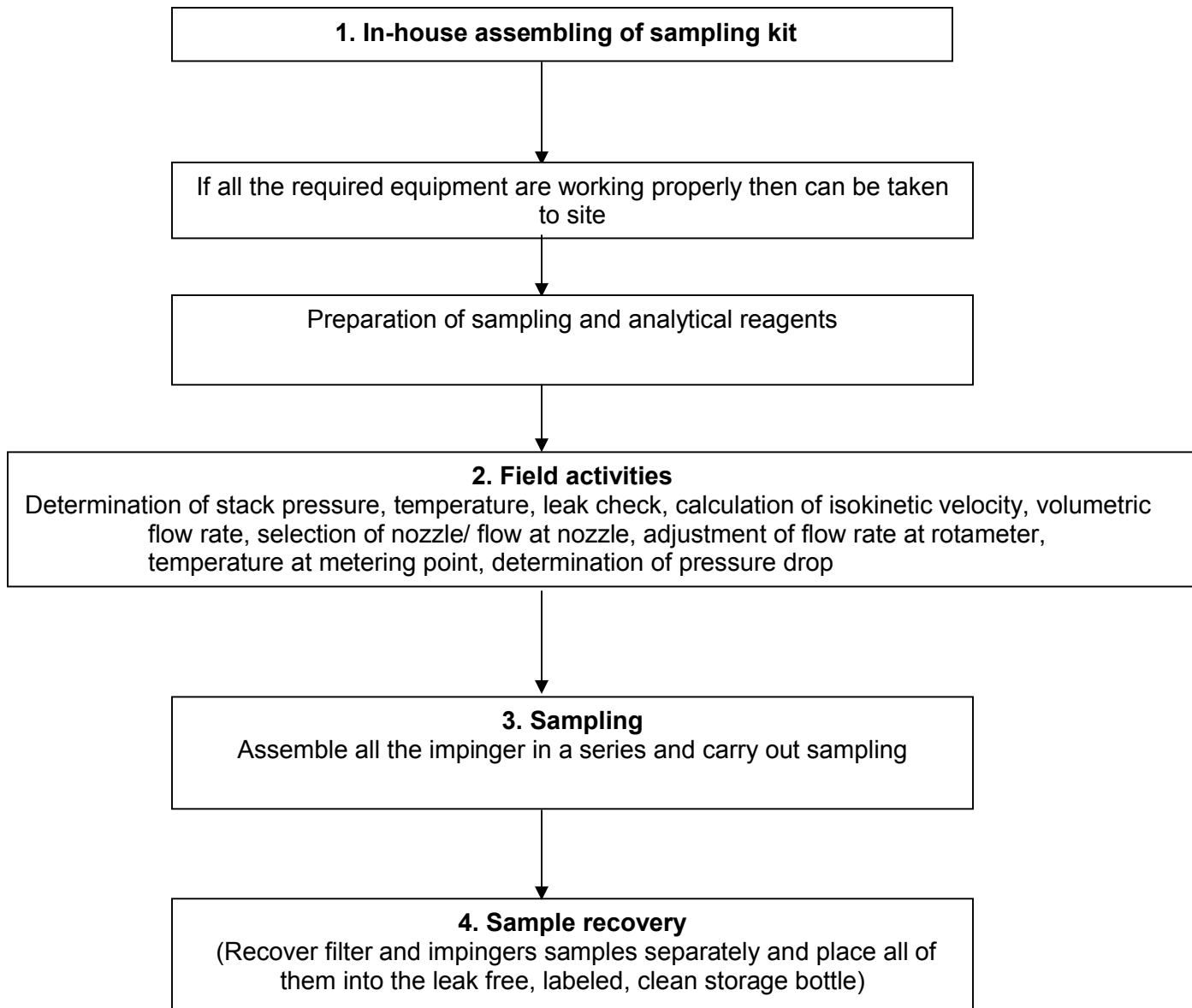

Figure 2: Sampling activity scheme

Table- 1

Field Data Sheet

Name & Address

Date & time of Sampling

Ambient Temperature °C

Barometric Pressure (mm mercury column)

Moisture in the flue gas (%) flue gas composition (CO₂ %, O₂ %, N₂)

Filter No and weight (Initial as well as Final)

Travers Point	Δ P (mm)	Ts (°K)	Ps	Us (m/s)	Qs (m ³ /hr)	Rs (LPM)	P _m		Rm (LPM)	Time (min)	DGM (m ³)		Vstd (Nm ³)
							P _{m0}	P _{m1}			Initial	Final	

Δ P = Stack Gas Velocity Pressure, (mm water column), Ts = Stack temperature (°K),
 Ps = Static pressure (mm water column), Us = Velocity of stack gas (m/s),
 Qs = Volumetric Flow Rate/ Discharge, Rs = Flow at nozzle (LPM),
 P_m = Vacuum Pressure Drop (mm mercury column),
 Rm = Determination of sampling rate at gas meter. (LPM),
 Vstd = Determination of volume of Gas Sampled

Other required information:

- Feed rate of hazardous waste
- The nature, composition and quantity of the material being incinerated during monitoring
- Installed and operating capacity of the incinerator
- No of sampling ports
- Internal diameter of the stack
- Nozzle size selected for sampling
- Pitot tube constant
- ID fan capacity
- Pollution control equipment installed and its status
- House keeping

Signature of sample collector

Verified by

Approved by

Occupier/
 Representative of
 the incinerator
 facility

CHAPTER- 5

DETERMINATION OF METALS AND NON METALS EMISSIONS FROM STATIONARY SOURCES

DETERMINATION OF METALS AND NON METALS EMISSIONS FROM STATIONARY SOURCES

1.0 PRINCIPLE

A stack sample is withdrawn isokinetically from the source, particulate emissions are collected in the probe and on a heated filter, and gaseous emissions are then collected in an aqueous acidic solution of hydrogen peroxide (analyzed for all metals including Hg) and an aqueous acidic solution of potassium permanganate (analyzed only for Hg). The recovered samples are digested, and appropriate fractions are analyzed for Hg by cold vapor atomic absorption spectroscopy (CVAAS) and for Sb, As, Ba, Be, Cd, Cr, Co, Cu, Pb, Mn, Ni, P, Se, Ag, Tl, and Zn by inductively coupled argon plasma emission spectroscopy (ICAP) or atomic absorption spectroscopy (AAS). Graphite furnace atomic absorption spectroscopy (GFAAS) is used for analysis of Sb, As, Cd, Co, Pb, Se, and Tl if these elements require greater analytical sensitivity then can be obtained by ICAP. One can choose AAS for analysis of all listed metals. Similarly, inductively coupled plasma-mass spectroscopy (ICP-MS) may be used for analysis of Sb, As, Ba, Be, Cd, Cr, Co, Cu, Pb, Mn, Ni, As, Tl and Zn.

2.0 APPLICABILITY

This method is applicable for determination of antimony (Sb), arsenic (As), barium (Ba), beryllium (Be), cadmium (Cd), chromium (Cr), cobalt (Co), copper (Cu), lead (Pb), manganese (Mn), mercury (Hg), nickel (Ni), phosphorus (P), selenium (Se), silver (Ag), thallium (Tl), and zinc (Zn) emissions from stationary sources. This method may be used to determine particulate emissions in addition to the metals emissions if the prescribed procedures and precautions are followed.

2.1 Range and sensitivity

Table: 1 Detection Limits ($\mu\text{g}/\text{m}^3$) for The Front – Half, The Back – Half, and Total Sampling Train using ICAP and ASS

Metal	Front – half: Probe and Filter	Back – half: Impingers 1 -3	Back – half: Impingers 4 – 6 ^a	Total Train:
Antimony	¹ 7.7 (0.7)	¹ 3.8 (0.4)		¹ 11.5 (1.1)
Arsenic	¹ 12.7 (0.3)	¹ 6.4 (0.1)		¹ 19.1 (0.4)
Barium	0.5	0.3		0.8
Beryllium	¹ 0.07 (0.05)	¹ 0.04 (0.03)		¹ 0.11 (0.08)
Cadmium	¹ 1.0 (0.02)	¹ 0.5 (0.01))		¹ 1.5 (0.03)
Chromium	¹ 1.7 (0.2)	¹ 0.8 (0.1)		¹ 2.5 (0.3)
Cobalt	¹ 1.7 (0.2)	¹ 0.8 (0.1)		¹ 2.5 (0.3)
Copper	1.4	0.7		2.1
Lead	¹ 10.1 (0.2)	¹ 5.0 (0.1)		¹ 15.1 (0.3)
Manganese	¹ 0.5 (0.2)	¹ 0.2 (0.1)		¹ 0.7 (0.3)
Mercury	² 0.06	² 0.3	² 0.2	² 0.56
Nickel	3.6	1.8		5.4

Phosphorus	18	9		27
Selenium	¹ 18 (0.5)	¹ 9 (0.3)		¹ 27 (0.8)
Silver	1.7	0.9 (0.7)		2.6
Thallium	¹ 9.6 (0.2)	¹ 4.8 (0.1)		¹ 14.4 (0.3)
Zinc	0.5	0.3		0.8

^aMercury analysis only.

¹Detection limit when analyzed by GFASS.

²Detection limit when analysed by CVAAS, estimated for Back- half and Total Train.

Note: Actual method detection limits may vary from these values, because the stack kit, QA/QC, expertise in sampling and analysis here considered as per USEPA.

3.0 INTERFERENCES

Iron (Fe) can be a spectral interference during the analysis of As, Cr, and Cd by ICAP. Aluminum (Al) can be a spectral interference during the analysis of As and Pb by ICAP. Generally, these interferences can be reduced by diluting the analytical sample, but such dilution raises the in-stack detection limits. Background and overlap corrections may be used to adjust for spectral interferences.

3.1 Sampling Train

It has general similarities to the particulate sampling train. A schematic of the sampling train is shown in Figure-1.

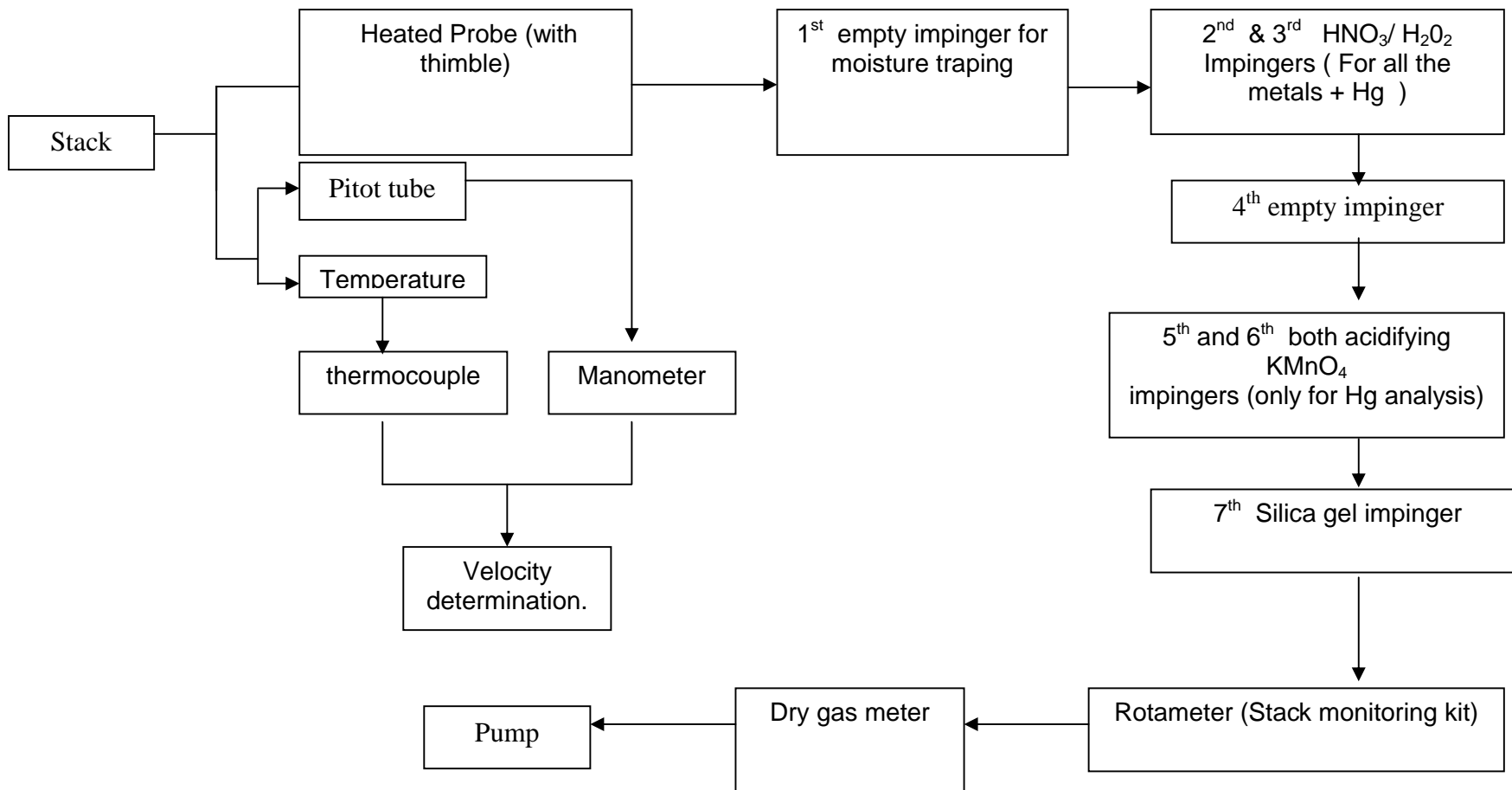

Fig 1: Sampling train for Metals and Non Metals

3.1.1 Condenser

Use the following system for condensing and collecting gaseous metals and determining the moisture content of the stack gas. The condensing system shall consist of four to seven impingers connected in series with leak-free ground glass fittings or other leak-free, non-contaminating fittings. Use the first impinger as a moisture trap. The second impinger (which is the first HNO₃ /H₂O₂ impinger) shall be identical to the first impinger. The third impinger (which is the second HNO₃ /H₂O₂ impinger) shall be a Greenburg Smith impinger with the standard tip. The fourth (empty) impinger and the fifth and sixth (both acidified KMnO₄) impingers. Place a thermometer capable of measuring temperature of 1 °C (2 °F) at the outlet of the last impinger. If no Hg analysis is planned, then the fourth, fifth, and sixth impingers are not required.

4.0 REAGENTS

4.1 Sampling Reagents

Table 1: Sampling reagents

S. No.	Reagent	Description
1	Sample Filters without organic binders	The filters shall contain less than 1.3 µg/in. of each of the metals to be measured. However, if glass fiber filters become available which meet these requirements, they may be used.
2	Ultrapure Distilled Water	All target metals should be less than 1 ng/ml.
3	Nitric Acid (HNO ₃).	Concentrated.
4	Hydrochloric Acid (HCL).	Concentrated
5	Hydrogen Peroxide (H ₂ O ₂)	30 Percent (V/V).
6	Potassium Permanganate (KMnO ₄).	
7	Sulfuric Acid (H ₂ SO ₄).	Concentrated
8	Silica Gel and Crushed Ice	

4.2 Pretest Preparation of Sampling Reagents

Table 2: Preparation of sampling reagents

S. No	Reagent	Procedure for preparation
1	HNO ₃ /H ₂ O ₂ Absorbing Solution, 5 Percent HNO ₃ /10 Percent H ₂ O ₂	Add carefully with stirring 50 ml of concentrated HNO ₃ to a 1000-ml volumetric flask containing approximately 500 ml of water, and then add carefully with stirring 333 ml of 30 percent H ₂ O ₂ . Dilute to volume with water. Mix well. This reagent shall contain less than 2 ng/ml of each target metal.

2	Acidic KMnO_4 Absorbing Solution	<p>Dissolve, with stirring, 40 g of KMnO_4 into 100 ml percent H_2SO_4 (V/V) and add 10 percent H_2SO_4 (V/V) with stirring to make a volume of 1 liter. Prepare and store in glass bottles to prevent degradation. This reagent shall contain less than 2 ng/ml of Hg.</p> <p>Precaution: To prevent autocatalytic decomposition of the permanganate solution, filter the solution through Whatman 541 filter paper. Also, due to the potential reaction of the potassium permanganate with the acid, there could be pressure buildup in the solution storage bottle. Therefore, these bottles shall not be fully filled and shall be vented to relieve excess pressure and prevent explosion potentials. Venting is required, but not in a manner that will allow contamination of the solution.</p>
3	0.1N HNO_3	<p>Add with stirring 6.3 ml of concentrated HNO_3 (70 percent) to a flask containing approximately 900 ml of water. Dilute to 1000 ml with water. Mix well. This reagent shall contain less than 2 ng/ml of each target metal.</p>
4	8 N HCl	<p>Carefully add with stirring 690 ml of concentrated HCl to a flask containing 250 ml of water. Dilute to 1000 ml with water. Mix well. This reagent shall contain less than 2 ng/ml of Hg.</p>

5.0 PROCEDURE

5.1 Sampling

The complexity of this method is such that, to obtain reliable results, both testers and analysts must be trained and experienced with the test procedures, including source sampling; reagent preparation and handling; sample handling; safety equipment and procedures; analytical calculations; reporting; and the specific procedural descriptions throughout this method.

5.1.1 Pretest preparation

Unless particulate emissions are to be determined, the filter need not be desiccated or weighed. First, rinse all sampling train glassware with hot tap water and then wash in hot soapy water. Next, rinse glassware three times with tap water, followed by three additional rinses with water. Then soak all glassware in a 10 percent (V/V) nitric acid solution for a minimum of 4 hours, rinse three times with water, rinse a final time with acetone, and allow to air dry. Cover all glassware openings where contamination can occur until the sampling train is assembled for sampling.

5.1.2 Preliminary determinations

Perform leak check. Determine the stack pressure, temperature, calculation of Isokinetic velocity, volumetric flow rate, flow at nozzle/ selection of nozzle, adjustment of flow rate at rotameter, temperature at metering point and volume of gas sampled, pressure drop during sampling as described in the SOP of the particulate matter.

Note:

Calculate isokinetic velocity and collect the sample following the SOP prescribed for particulate monitoring.

5.1.3 Preparation of sampling train:

Set up the sampling train as shown in Figure-1. Use the first impinger (empty) as a moisture trap, place 100 ml of the $\text{HNO}_3/\text{H}_2\text{O}_2$ solution in each of the second and third impingers as shown in Figure -1. Keep another Empty impinger in 4th position. Place 100 ml of the acidic KMnO_4 absorbing solution in each 5th and 6th impingers as shown in Figure 1, and transfer approximately 200 to 300 g of pre-weighed silica gel from its container to the last impinger.

If Hg analysis will not be performed, the fourth, fifth, and sixth impingers as shown in Figure -1 are not required.

To insure leak-free sampling train connections and to prevent possible sample contamination problems, use Teflon tape or other non-contaminating material instead of silicone grease.

Precaution: Exercise extreme care to prevent contamination within the train. Prevent the acidic KMnO_4 from contacting any glassware that contains sample material to be analyzed for Mn. Prevent acidic H_2O_2 from mixing with the acidic KMnO_4 .

Leak Check Procedures. Initial and final reading in Hg guage should be noted. If the pressure drop during sampling is not quantifiable then the whole process shall be repeated after ensuring there is no leak in sampling train

5.2 Sample Recovery

Begin cleanup procedures as soon as the probe is removed from the stack at the end of a sampling period. The probe should be allowed to cool prior to sample recovery. When it can be safely handled, wipe off all external particulate matter near the tip of the probe nozzle and place a rinsed, non-contaminating cap over the probe nozzle to prevent losing or gaining particulate matter. Do not cap the probe tip tightly while the sampling train is cooling; a vacuum can form in the filter holder with the undesired result of drawing liquid from the impingers onto the filter.

Before moving the sampling train to the cleanup site, remove the probe from the sampling train and cap the open outlet. Be careful not to lose any condensate that might be present. Cap the filter inlet where the probe was fastened. Remove the umbilical cord from the last impinger and cap the impinger. Cap the filter holder

outlet and impinger inlet. Use non contaminating caps, whether ground-glass stoppers, plastic caps, serum caps, or Teflon tape to close these openings.

Transfer the probe and filter-impinger assembly to a cleanup area that is clean and protected from the wind and other potential causes of contamination or loss of sample. Inspect the train before and during disassembly and note any abnormal conditions. Take special precautions to assure that all the items necessary for recovery do not contaminate the samples.

Container No. 1 (Sample Filter). Carefully remove the filter from the filter holder and place it in its labeled petri dish container. To handle the filter, use either acidwashed polypropylene or Teflon coated tweezers or clean, disposable surgical gloves rinsed with water and dried. If it is necessary to fold the filter, make certain the particulate cake is inside the fold. Carefully transfer the filter and any particulate matter or filter fibers that adhere to the filterholder gasket to the petri dish by using a dry (acid cleaned) nylon bristle brush. Do not use any metal-containing materials when recovering this train. Seal the labeled petri dish. See the Figure – 2.

Container No. 2 (Probe Rinse). Keep the probe assembly clean and free from contamination during the probe rinse. Rinse the probe nozzle and fitting, probe liner, and front-half of the filter holder thoroughly with a total of 100 ml of 0.1 N HNO₃, and place the wash into a sample storage container.

Note: The use of a total of exactly 100 ml is necessary for the subsequent blank correction procedures. Record the volume of the rinses Mark the height of the fluid level on the outside of the Storage container and use this mark to determine if leakage occurs during transport. Seal the container, and clearly label the contents. Finally, rinse the nozzle, probe liner, and front-half of the filter holder with water followed by acetone, and discard these rinses. See figure – 2.

Container No. 3 (Impingers 1 through 3, Moisture Knockout Impinger when used, HNO₃ /H₂O₂ Impingers Contents and Rinses). Due to the potentially large quantity of liquid involved, the tester may place the impinger solutions from impingers 1 through 3 in more than one container, if necessary. Measure the liquid in the first three impingers to within 0.5 ml using a graduated cylinder. Record the volume. This information is required to calculate the moisture content of the sampled flue gas. Clean each of the first three impingers, the filter support, the back half of the filter housing, and connecting glassware by thoroughly rinsing with 100 ml of 0.1 N HNO₃

Note: The use of exactly 100 ml of 0.1 N HNO₃ rinse is necessary for the subsequent blank correction procedures. Combine the rinses and impinger solutions, measure and record the final total volume. Mark the height of the fluid level, seal the container, and clearly label the contents.

See figure 2.1

Container Nos.4A (0.1 N HNO₃), 4B (KMnO₄ /H₂ SO₄ absorbing solution), and 4C (8 N HCl rinse and dilution).

When sampling for Hg, pour the liquid from impinger No. 4 into a graduated cylinder and measure the volume to within 0.5 ml. This information is required to

calculate the moisture content of the sampled flue gas. Place the liquid in Container No. 4A. Rinse the impinger with exactly 100 ml of 0.1 N HNO₃ and place this rinse in Container No. 4A.

Pour all the liquid from the two permanganate impingers into a graduated cylinder and measure the volume to within 0.5 ml. This information is required to calculate the moisture content of the sampled flue gas. Place this acidic KMnO₄ solution into Container No. 4B. Using a total of exactly 100 ml of fresh acidified KMnO₄ solution for all rinses (approximately 33 ml per rinse), Similarly, using 100 ml total of water, rinse the permanganate impingers and connecting glass a minimum of three times, and pour the rinses into Container 4B, carefully assuring transfer of any loose precipitated material. Mark the height of the fluid level, and clearly label the contents.

NOTE: Due to the potential reaction of KMnO₄ with acid, pressure buildup can occur in the sample storage bottles. Do not fill these bottles completely and take precautions to relieve excess pressure.

If deposits remain on the impinger surfaces, wash them with 25 ml of 8 N HCl, and place the wash in a separate sample Container No. 4C containing 200 ml of water. First, place 200 ml of water in the container. Then wash the impinger walls and stem with the HCl by turning the impinger on its side and rotating it so that the HCl contacts all inside surfaces. Use a total of only 25 ml of 8 N HCl for rinsing both permanganate impingers combined. Rinse the first impinger, then pour the actual rinse used for the first impinger into the second impinger for its rinse. Finally, pour the 25 ml of 8 N HCl rinse carefully into the container. Mark the height of the fluid level on the outside of the container to determine if leakage occurs during transport. See figure 2.2

Container No. 5 (Silica Gel). Note the color of the indicating silica gel to determine whether it has been completely spent and make a notation of its condition. Transfer the silica gel from its impinger to its original container and seal it. The small amount of particles that might adhere to the impinger wall need not be removed. Do not use water or other liquids to transfer the silica gel since weight gained in the silica gel impinger is used for moisture calculations. Alternatively, if a balance is available in the field, record the weight of the spent silica gel (or silica gel plus impinger) to the nearest 0.5 g.

Container No. 6A (0.1 N HNO₃ Blank).

Container No. 6B (Water Blank).

Container No. 7 (5 Percent HNO₃ /10 Percent H₂O₂ Blank).

Container No. 8 (Acidified KMnO₄ Blank).

Container No. 9 (8 N HCl Blank).

Container No. 10 (Sample Filter Blank).

5.3 Sample Preparation

Note the level of the liquid in each of the containers and determine if any sample was lost during shipment. A diagram illustrating sample preparation and analysis procedures for each of the sample train components is shown in Figure -3 and Figure - 3.1

Container No. 1 (Sample Filter).

If particulate emissions are being determined, first desiccate the filter and filter catch without added heat (do not heat the filters to speed the drying) and weigh to a constant weight as described in the term "constant weight" means a difference of no more than 0.5 mg or 1 percent of total weight less tare weight, whichever is greater, between two consecutive weighings, with no less than 6 hours of desiccation time between weighings.

Option I – Microwave digestion

Make pieces of filter papers/thimbles (Do not use metallic scissor). Place the pieces in the analyst's choice of either individual microwave pressure relief vessels or Parr^R Bombs. Add 6 ml of concentrated HNO₃ and 4 ml of concentrated HF to each vessel. For microwave heating, microwave the samples for approximately 12 to 15 minutes total heating time as follows: heat for 2 to 3 minutes, then turn off the microwave for 2 to 3 minutes, then heat for 2 to 3 minutes, etc., continue this alternation until the 12 to 15 minutes total heating time are completed (this procedure should comprise approximately 24 to 30 minutes at 600 watts). Microwave heating times are approximate and are dependent upon the number of samples being digested simultaneously. Sufficient heating is evidenced by sorbent reflux within the vessel. Then cool the samples to room temperature.

Option II

Place the pieces of thimbles in acid cleaned beaker add about 50 ml water, add 6 ml of concentrated HNO₃ and 4 ml of concentrated HF to it. Place it on hot plate under fume extraction hood. Set the Temperature at 70 °C. Continue to digest for 12 hrs.

Container No. 2 (Probe Rinse)

Verify that the pH of this sample is 2 or lower. If it is not, acidify the sample by careful addition with stirring of concentrated HNO₃ to pH 2. Use water to rinse the sample into a beaker, and cover the beaker with a ribbed watch glass. Reduce the sample volume to approximately 20 ml by heating on a hot plate at a temperature below boiling. Add 6 ml of concentrated HNO₃ and 4 ml of concentrated HF to it. Place it on hot plate under fume extraction hood. Set the Temperature at 70 °C Continue the digestion for 12 hrs.

If the sampling train includes an optional glass cyclone in front of the filter, prepare and digest the cyclone catch by the same way.

Then combine the resultant sample directly with the acid digested portions of the filter prepared previously, acid rinse concentrate and cyclone catch concentrate (If done). Filter the combined sample using Whatman 41 filter paper. Dilute to 300 ml (or the appropriate volume for the expected metals concentration) with water. This diluted sample is "Analytical Fraction 1". Measure and record the volume of Analytical Fraction 1 to within 0.1 ml. Quantitatively remove a 50-ml aliquot and label as "Analytical Fraction 1B". Label the remaining 250-ml portion as "Analytical Fraction 1A". Analytical Fraction 1A is used for ICAP or AAS analysis for all desired metals except Hg. Analytical Fraction 1B is used for the determination of front-half Hg. This fraction should be treated with acid and KMnO₄ at 90°C for 2

hours. Excess KMnO_4 should be removed by using Hydroxylamine Hydrochloride before analysis of Hg.

Container No.3 (Impingers 1-3)

Measure and record the total volume of this sample to within 0.5 ml, if the leakage found significant make up with fresh distilled water. Remove a 75- to 100-ml aliquot for Hg analysis and label the aliquot "Analytical Fraction 3B". Label the remaining portion as "Sample Fraction 3A". Verify that the pH of Sample Fraction 3A is 2 or lower. If necessary, use concentrated HNO_3 by careful addition and stirring to lower the pH upto 2. Use water to rinse Sample Fraction 3A into a beaker and then cover the beaker with a ribbed watch glass. Reduce Sample to approximately 20 ml by heating on a hot plate at a temperature just below boiling. Add 30 ml of 50 percent HNO_3 , and heat for 30 minutes on a hot plate to just below boiling. Add 10 ml of 3 percent H_2O_2 and heat for 10 more minutes. Add 50 ml of hot water, and heat the sample for an additional 20 minutes. Cool, filter the sample, and dilute to 150 ml (or the appropriate volume for the expected metals concentrations) with water. Analytical Fraction 3A is analyzed for all metals except Hg.

Analytical fraction 3B will be digested separately with HCl and KMnO_4 at 90 °C for two hours. Excess Permanganate should be removed by Hydrxylamine Hydrochloride before analysis in Cold Vapour AAS.

Container No. 4A (Empty impnger washing liquid with 0.1 N HNO_3), 4B (KMnO_4 / H_2SO_4 absorbing solution of impinger 5 and 6), and 4C (8 N HCl rinse of impinger 5 and 6 for scaling of MnO_2)

Keep the samples in Containers Nos. 4A, 4B, and 4C separate from each other. Measure and record the volume of 4A to within 0.5 ml. Concentrate the sample upto 20 ml on hot plate at below boiling temperature. Keep it separate.

To remove any brown MnO_2 precipitate from the contents of Container No. 4B, filter its contents through Whatman 40 filter paper into a 500 ml volumetric flask, make up the volume with distilled water. This fraction is analytical fraction 4B.

Save the filter for digestion of the brown MnO_2 precipitate. Place the saved filter into an appropriately sized vented container, which will allow release of any gases including chlorine formed when the filter is digested in a laboratory hood. Add 25 ml of 8 N HCl to the filter and allow to digest for a minimum of 24 hours at room temperature. Filter the contents of Container No. 4C through a Whatman 40 filter into a 500-ml volumetric flask. Then filter the result of the digestion of the brown MnO_2 from Container No. 4B through a Whatman 40 filter into the same 500-ml volumetric flask, and dilute and mix well to volume with water. Discard the Whatman 40 filter. Mark this combined 500-ml dilute HCl solution as Analytical fraction 4C. So three samples will be generated in this section for Hg analysis. All these fractions shall be digested and concentrated to desired volume with HCl and KMnO_4 at 90 °C for two hours. Excess Permanganate should be removed by Hydrxylamine Hydrochloride before analysis in Cold Vapour AAS.

Container No. 6 (Silica Gel). Weigh the spent silica gel (or silica gel plus impinger) to the nearest 0.5 g using a balance.

5.4 Sample Analysis

For each sampling train sample run, seven individual analytical samples are generated ; two (Analytical fraction 1A and 3A) for all desired metals except Hg, and five for Hg (Analytical fraction 1B, 3B, 4A, 4B and 4C). A schematic identifying each sample container and the prescribed analytical preparation and analysis scheme is shown in Figure 3 and Figure 3.1. Blanks for all reagents used should be processed with samples in parallel.

6.0 CALCULATIONS

For Molecular weight determination, Stack gas velocity, Isokinetic Flow rate, Moisture content and parameters required for particulate emission calculation follow the formulae mentioned in method prescribed for particulate matter determination.

Dry Gas Volume. Using the data from this test, calculate $V_{m(std)}$, the dry gas sample volume at standard conditions as outline Correct the sample volume measured by the dry gas meter to standard conditions (25°C, 760 mm Hg or 68°F, 29.92in. Hg) by using following Equation. Where, Y is DGM Calibration Factor.

$$V_{mstd} = V_m Y \left[\frac{T_{std}}{T_m} \right] \left[\frac{P_{bar}}{P_{std}} \right] = K_1 Y V_m \left[\frac{P_{bar}}{T_m} \right]$$

Where:

$$K_1 = 0.3858 \text{ } ^\circ\text{K/mm Hg for metric units,}$$

$$= 17.64 \text{ } ^\circ\text{C/in. Hg for English units}$$

$$P_{bar} = \text{Barometric pressure at the exit orifice of the DGM, mm Hg (in. Hg).}$$

$$P_{std} = \text{Standard absolute pressure, 760 mm Hg (29.92 in. Hg).}$$

$$T_m = \text{Average DGM absolute temperature, } ^\circ\text{K (} ^\circ\text{c).}$$

$$T_{std} = \text{Standard absolute temperature, } 293^\circ\text{K}$$

$$Y = \text{Dry gas meter calibration factor}$$

$$V_{m(std)} = \text{Dry gas volume measured by the dry gas meter, corrected to standard conditions, Nm}^3$$

$$V_m = \{ \text{Sampling rate in gas channel (LPM) X duration (Minutes)} \} / 1000 \text{ m}^3.$$

Calculate all the seven fraction (2 for other metals and 5 for mercury) in mass of individual elements following the formula

Metals (Except Hg) in Source Sample.

$$M_x = C_x \text{ (ppm)} * D * V_{ds}$$

where:

M_x = Total mass of each metal in μg .

C_x = Concentration of metal in respective Fraction as read from the standard curve in $\mu\text{g/ml}$ (ppm) after respective blank subtraction

D = Dilution Factor

V_{ds} = Total volume of digested sample solution in Analytical Fraction ml.

M_x values calculated for fraction 1A and 3A should be added individually to represent total mass for each metals except Hg. The concentration emitted from stack would be calculated as below.

$$\{M_x(1A) + M_x(3A)\} * 10^{-3} / V_{m(std)} \quad \text{mg/NM}^3$$

Similarly for Hg

$$\{M_x(1B) + M_x(3B) + M_x(4A) + M_x(4B) + M_x(4C)\} * 10^{-3} / V_{m(std)} \quad \text{mg/NM}^3$$

Note: Report concentration as corrected at 11% O_2

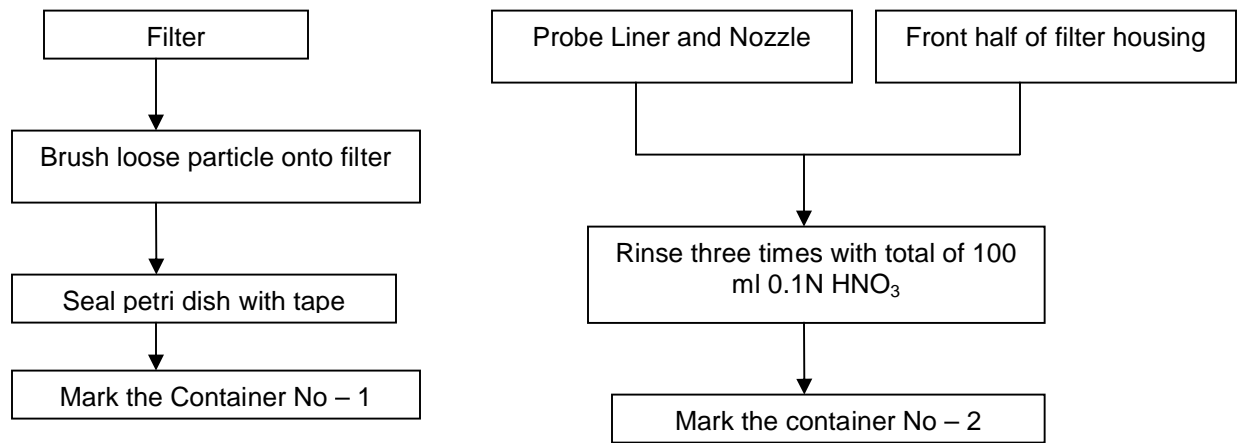

Figure –2 : Sample Recovery Scheme for Sample filter, Probe rinse, Front half the filter housing

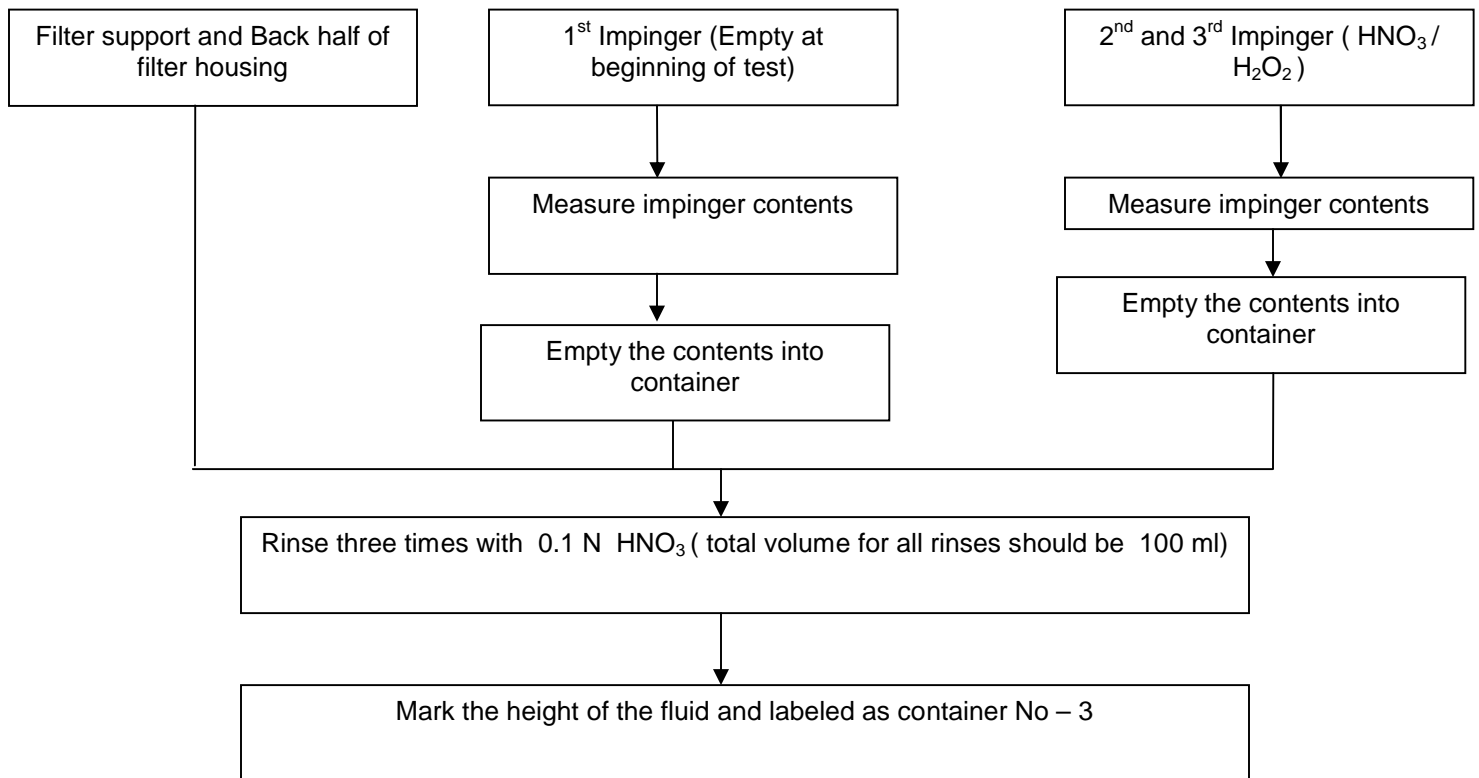

Figure –2.1: Sample Recovery Scheme for Filter support and Back half of filter housing, 1st(Empty) , 2nd ,3rd Impinger (HNO₃ /H₂O₂)

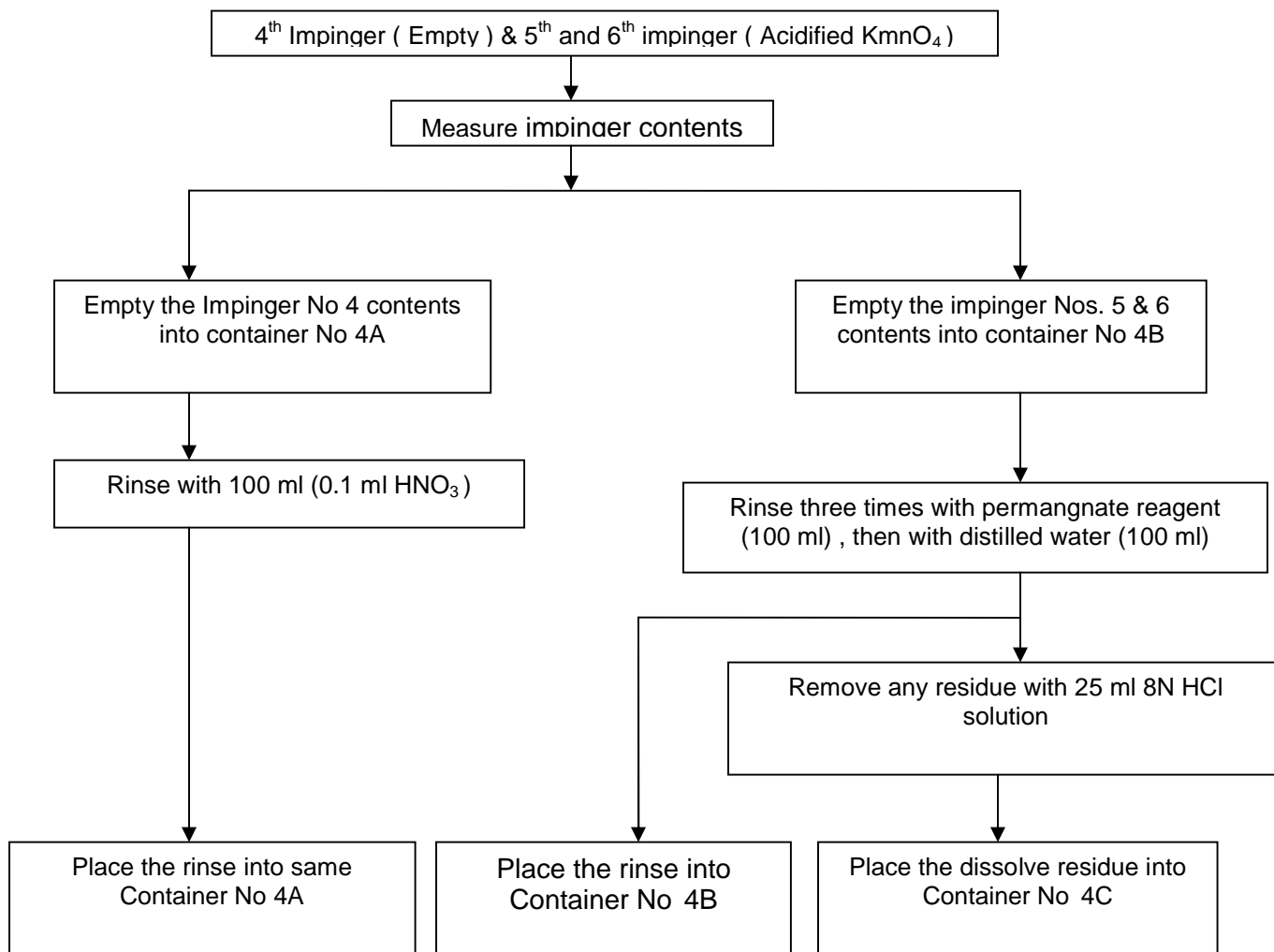

Figure – 2.2: Sample Recovery Scheme 4th Impinger (Empty) & 5th and 6th Impinger (Acidified KmnO₄)

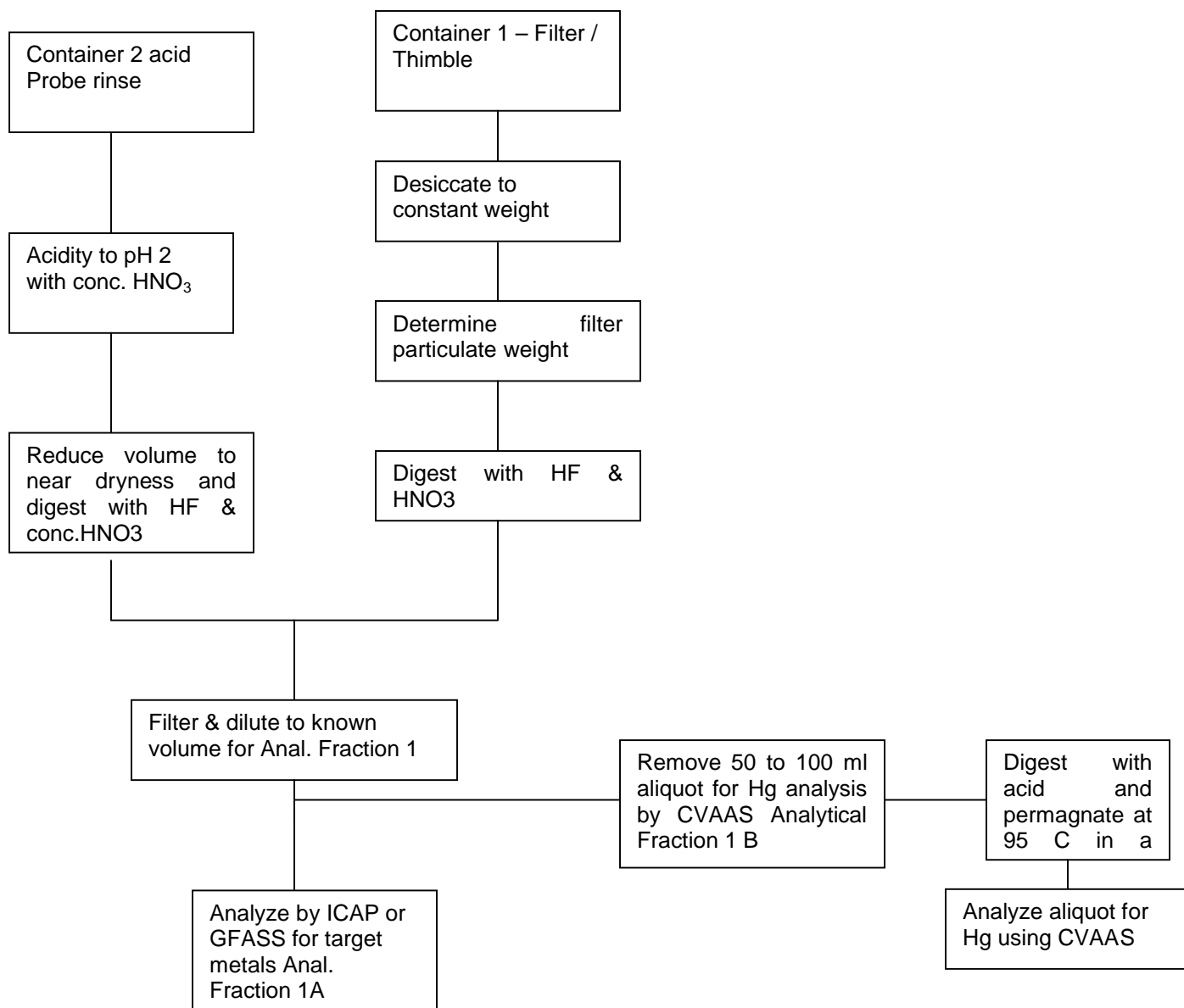

Figure - 3: Sample Preparation and Analysis Scheme.

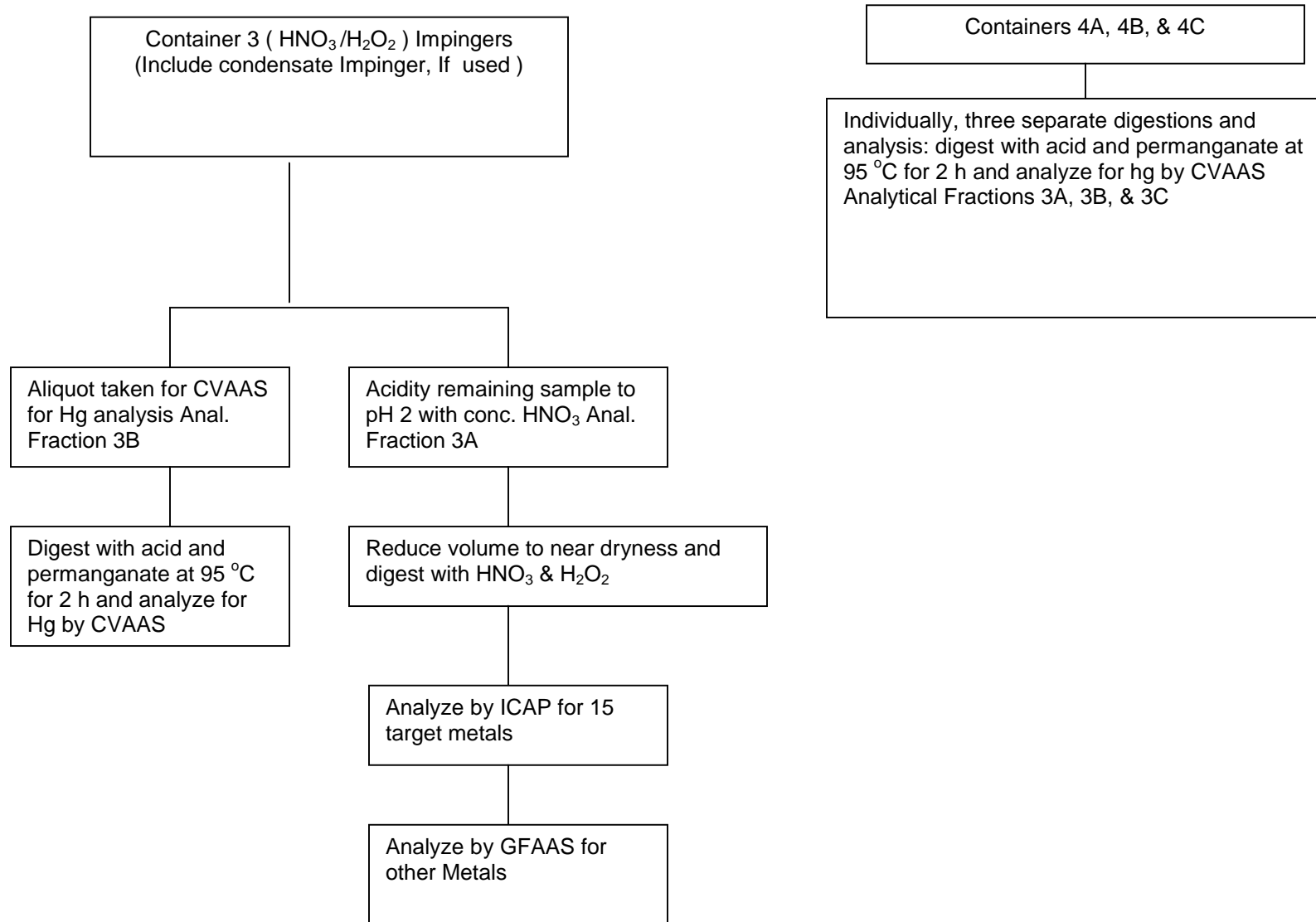

Figure - 3.1: Sample Preparation and Analysis Scheme.

7.0 REFERENCES

1. Method 303F in Standard Methods for the Examination of Water Wastewater, 15th Edition, 1980. Available from the American Public Health Association, 1015 18th Street N.W., Washington, D.C. 20036.
2. EPA Methods 6010, 6020, 7000, 7041, 7060, 7131, 7421, 7470, 7740, and 7841, Test Methods for Evaluating Solid Waste: Physical/Chemical Methods. SW-846, Third Edition, November 1986, with updates I, II, IIA and IIB. Office of Solid Waste and Emergency Response, U. S. Environmental Protection Agency, Washington, D.C. 20460.
3. EPA Method 200.7, Code of Federal Regulations, Title 40, Part 136, Appendix C. July 1, 1987.
4. EPA Methods 1 through 5, Code of Federal Regulations, Title 40, Part 60, Appendix A, July 1, 1991.
5. EPA Method 101A, Code of Federal Regulations, Title 40, Part 61, Appendix B, July 1, 1991.

CHAPTER - 6

**Standard Operating Procedure (SOP) for Sampling of Metals and
Non Metals**

&

**Standard Operating Procedure (SOP) of Sample Preparation for
Analysis
of Metals and Non Metals**

Disclaimer:

These Standard Operating Procedures (SOPs) are only guidelines for sampling and analysis of metals and non metals in incinerator stack emissions. Concerned Institutes/ Organizations/ laboratories may modify the analytical part according to their need; infrastructure and men power training involved maintaining the QA/QC protocol as required by the method.

STANDARD OPERATING PROCEDURE FOR SAMPLING OF METALS AND NON METALS

1.0 Purpose and Applicability

This method is applicable for determination of antimony (Sb), arsenic (As), barium (Ba), beryllium (Be), cadmium (Cd), chromium (Cr), cobalt (Co), copper (Cu), lead (Pb), manganese (Mn), mercury (Hg), nickel (Ni), phosphorus (P), selenium (Se), silver (Ag), thallium (Tl), and zinc (Zn) emissions from stationary sources. This method may be used to determine particulate emissions in addition to the metals emissions if the prescribed procedures and precautions are followed.

1.1 Range and sensitivity

Table: 1 Detection Limits ($\mu\text{g}/\text{m}^3$) for The Front – Half, The Back – Half, and Total Sampling Train using ICAP and ASS

Metal	Front – half: Probe and Filter	Back – half: Impingers 1 - 3	Back – half: Impingers 4 – 6 ^a	Total Train:
Antimony	¹ 7.7 (0.7)	¹ 3.8 (0.4)		¹ 11.5 (1.1)
Arsenic	¹ 12.7 (0.3)	¹ 6.4 (0.1)		¹ 19.1 (0.4)
Barium	0.5	0.3		0.8
Beryllium	¹ 0.07 (0.05)	¹ 0.04 (0.03)		¹ 0.11 (0.08)
Cadmium	¹ 1.0 (0.02)	¹ 0.5 (0.01))		¹ 1.5 (0.03)
Chromium	¹ 1.7 (0.2)	¹ 0.8 (0.1)		¹ 2.5 (0.3)
Cobalt	¹ 1.7 (0.2)	¹ 0.8 (0.1)		¹ 2.5 (0.3)
Copper	1.4	0.7		2.1
Lead	¹ 10.1 (0.2)	¹ 5.0 (0.1)		¹ 15.1 (0.3)
Manganese	¹ 0.5 (0.2)	¹ 0.2 (0.1)		¹ 0.7 (0.3)
Mercury	² 0.06	² 0.3	² 0.2	² 0.56
Nickel	3.6	1.8		5.4
Phosphorus	18	9		27
Selenium	¹ 18 (0.5)	¹ 9 (0.3)		¹ 27 (0.8)
Silver	1.7	0.9 (0.7)		2.6
Thallium	¹ 9.6 (0.2)	¹ 4.8 (0.1)		¹ 14.4 (0.3)
Zinc	0.5	0.3		0.8

^aMercury analysis only.

¹Detection limit when analyzed by GFASS.

²Detection limit when analysed by CVAAS, estimated for Back- half and Total Train.

Note: Actual method detection limits may vary from these values, because the stack kit, QA/QC, expertise in sampling and analysis here considered as per USEPA.

2.0 Pre sampling activity

- Rinse all sampling train glassware with hot tap water and then wash in hot soapy water.
- Rinse glassware three times with tap water, followed by three additional rinses with distilled water.
- Soak all glassware in a 10 percent (V/V) nitric acid solution for a minimum of 4 hours, later rinse three times with distilled water, rinse finally with acetone, and allow to air dry.
- Cover all glassware openings where contamination can occur until the sampling train is assembled for sampling.

3.0 Preparation of reagent

3.1 Sampling Reagents

- Sample Filters without any organic binders
EPM/GF filters shall contain less than $1.3 \mu\text{g}/\text{in}^2$ of each of the metals to be measured.
- Ultrapure distilled water.
- Concentrated Nitric Acid (HNO_3)
- Concentrated Hydrochloric Acid (HCL)
- Hydrogen Peroxide (H_2O_2) 30 Percent (V/V)
- Potassium Permanganate (KMnO_4)
- Sulfuric Acid (H_2SO_4)
- Silica Gel

3.2 Preparation of sampling reagents

- HNO_3 / H_2O_2 Absorbing Solution, 5 Percent HNO_3 /10 Percent H_2O_2

Add 50 ml of concentrated HNO_3 to a 1000-ml volumetric flask containing approximately 500 ml of water add carefully with stirring 333 ml of 30 percent H_2O_2 . Make up the volume with distilled water.

- Acidic KMnO_4 Absorbing Solution (4 % KMnO_4 (W/V), in 10 Percent H_2SO_4 (V/V).

Mix carefully, with stirring, 100 ml of concentrated H_2SO_4 into approximately 800 ml of water, and add water with stirring to make a volume of 1 liter: this solution is 10 % H_2SO_4 (V/V). Dissolve 40 g of KMnO_4 into 10 percent H_2SO_4 (V/V) and add 10 % H_2SO_4 (V/V) with stirring to make a volume of 1 liter. Prepare and store in glass bottles to prevent degradation.

Note:

To prevent autocatalytic decomposition of the permanganate solution, filter the solution through Whatman 541 filter paper. Also, due to the potential reaction of the potassium permanganate with the acid, there could be pressure buildup in the solution storage bottle. Therefore, these bottles shall not be fully filled and shall be vented to relieve excess pressure and prevent explosion potentials. Venting is required, but not in a manner that will allow contamination of the solution.

- 0.1N HNO_3
Add 6.3 ml of concentrated HNO_3 (70 percent) to a flask containing approximately 900 ml of distilled water. Dilute to 1000 ml with distilled water.
- 8 N HCl
Add stirring 690 ml of concentrated HCl to a flask containing 250 ml of water. Dilute to 1000 ml with water.
Note: All the reagent shall satisfy the less than 2 ng/ml of each target metals.

4.0 Preparation of sampling train

- Assemble the sampling train as shown in the Figure – 1.
- Select First impinger as a moisture trap.
- Put 100 ml of the $\text{HNO}_3/\text{H}_2\text{O}_2$ solution in the second and the third impinger.
- Keep fourth impinger empty.
- Place 100 ml of the acidic KMnO_4 absorbing solution in each 5th and 6th impingers
- Take 200 to 300 g of pre-weighed silica gel in the last impinger.

If Hg analysis will not be performed, the fourth, fifth, and sixth impingers as shown in Figure -1 are not required.

Precaution: Prevent the acidic KMnO_4 from contacting any glassware that contains sample material to be analyzed for Mn. Prevent acidic H_2O_2 from mixing with the acidic KMnO_4 . Uses of amber glass impinger are recommended for acidic KMnO_4 Solution.

5.0 Field activity

Perform leak check. Determine the stack pressure, temperature, calculation of Isokinetic velocity, volumetric flow rate, flow at nozzle/ selection of nozzle, adjustment of flow rate at rotameter, temperature at metering point and volume of gas sampled, pressure drop during sampling as described in the SOP of the particulate matter.

Note:

Calculate isokinetic velocity and collect the sample following the SOP prescribed for Particulate monitoring.

6.0 Sample Recovery

- Cool the probe, Transfer the probe and filter assembly to a clean area, cap all the open outlet with the non-contaminated glass stoppers or plastic cap.
- Take special precautions to assure that all the items necessary for recovery do not contaminate the samples.
- Container No. 1 (Sample Filter)

Remove filter from the filter holder; Place it in the labeled petri dish container. Seal the petri dish. See the Figure – 2

- Container No. 2 (Probe Rinse)

- Rinse the probe nozzle and fitting, probe liner, and front-half of the filter holder thoroughly with a total of 100 ml of 0.1 N HNO_3 , and place the wash into a sample storage container.
- Use of a total 100 ml is necessary for the subsequent blank correction procedures
- Put the mark on the storage container for the fluid level to determine leakage during transportation.
See the figure – 2

- Container No. 3 (Impingers 1 through 3, Moisture Knockout Impinger when used, HNO₃ /H₂O₂ Impingers Contents and Rinses)
 - Measure the liquid in the first three impingers to within 0.5 ml using a graduated cylinder. Record the volume. This information is required to calculate the moisture content of the sampled flue gas.
 - Clean each of the first three impingers, the filter support, the back half of the filter housing, and connecting glassware by thoroughly rinsing with exactly 100 ml of 0.1 N HNO₃. Mark the height of the fluid level, seal and label the contents.
 - See Figure 2.1
- Container Nos.4A (0.1 N HNO₃)
 - Measure the volume 0.5 ml of impinger No 4
 - Place the liquid in Container No 4A. Rinse the impinger with exactly 100 ml of 0.1 N HNO₃. Place this rinse into the same Container No 4A.
- 4B (KMnO₄ /H₂ SO₄ absorbing solution)
 - Pour all the solution of 5th & 6th impinger into the container No 4B. measure the volume to within 0.5 ml
 - Rinse the impingers (5th & 6th) with exactly 100 ml of fresh acidifying KMnO₄ solution into for all rinses (Approximately 33 ml per rinse).
 - Similarly, use 100 ml distilled water for the rinsing of 5th & 6th impingers and connecting glass minimum three times, pour this rinses into the container No 4B.
 - Don't fill these bottle completely, Take precaution to relive excess pressure.
- 4C (8 N HCl rinse and dilution)
 - Remove the residue of Impinger No 5th & 6th with exactly 25 ml 8N HCl.
 - Place this wash into different container ie 4C which contain 200 ml of water.
 - Mark the container for fluid level.
 - See Figure – 2.2
- Container No. 5 (Silica Gel).
 - Transfer the silica gel from its impinger to its original container and seal it.
 - If a balance is available in the field, record the weight of the spent silica gel (or silica gel plus impinger) to the nearest 0.5 g.
- Container No. 6A (0.1 N HNO₃ Blank).
- Container No. 6B (Water Blank).
- Container No. 7 (5 Percent HNO₃ /10 Percent H₂O₂ Blank).
- Container No. 8 (Acidified KMnO₄ Blank).
- Container No. 9 (8 N HCl Blank).
- Container No. 10 (Sample Filter Blank).

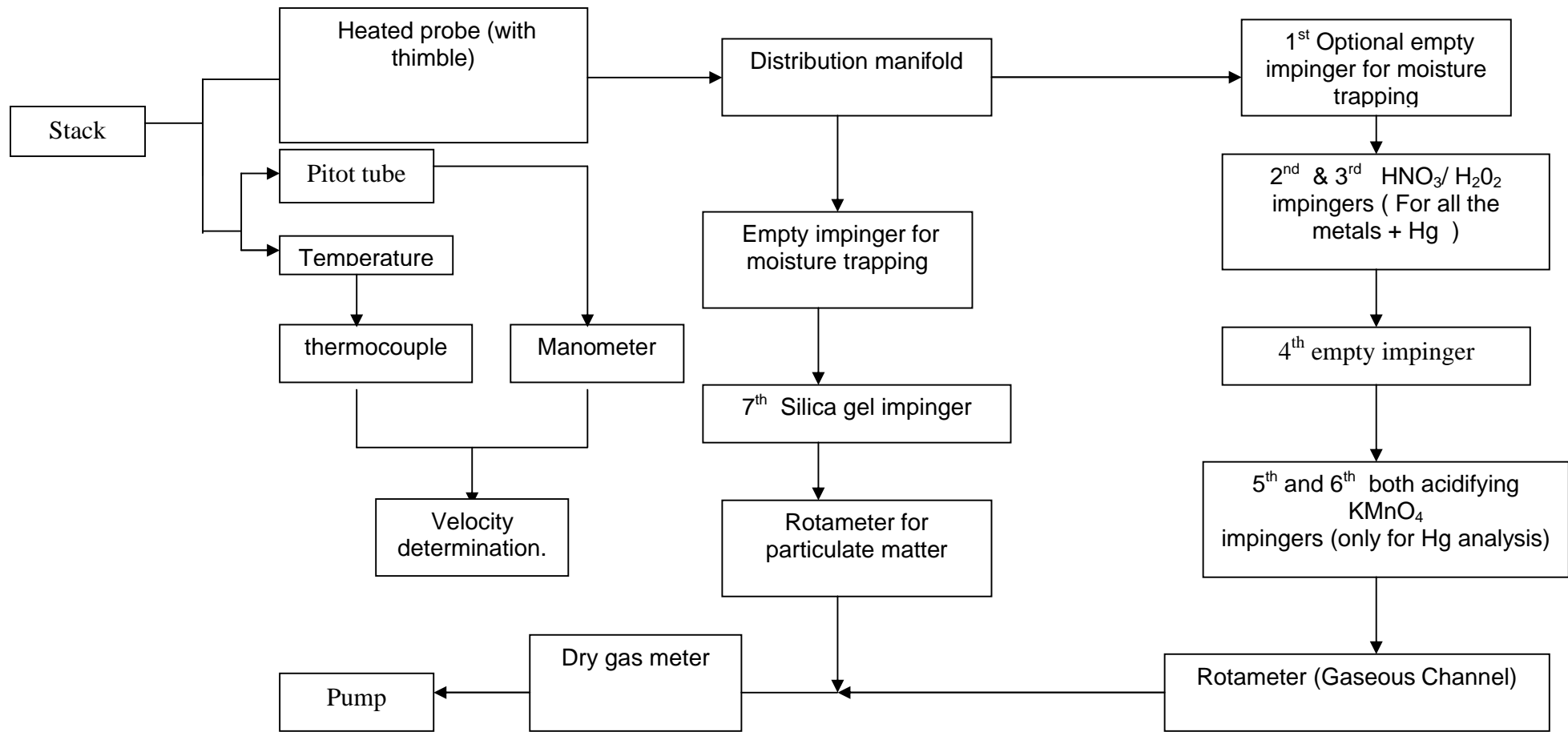

Figure - 1: Sampling Train for Metals and Non Metals

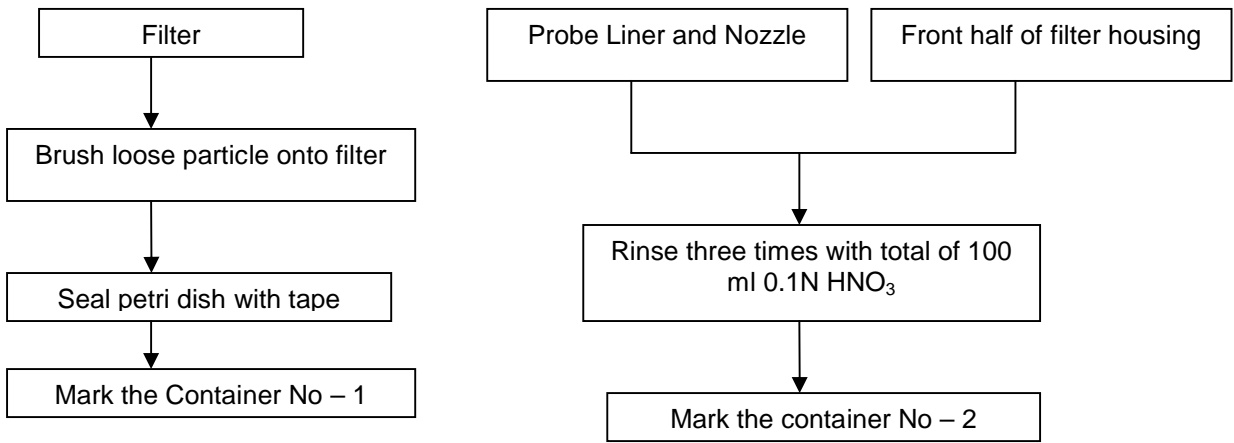

Figure -2: Sample Recovery Scheme for Sample filter, Probe rinse, Front half the filter housing

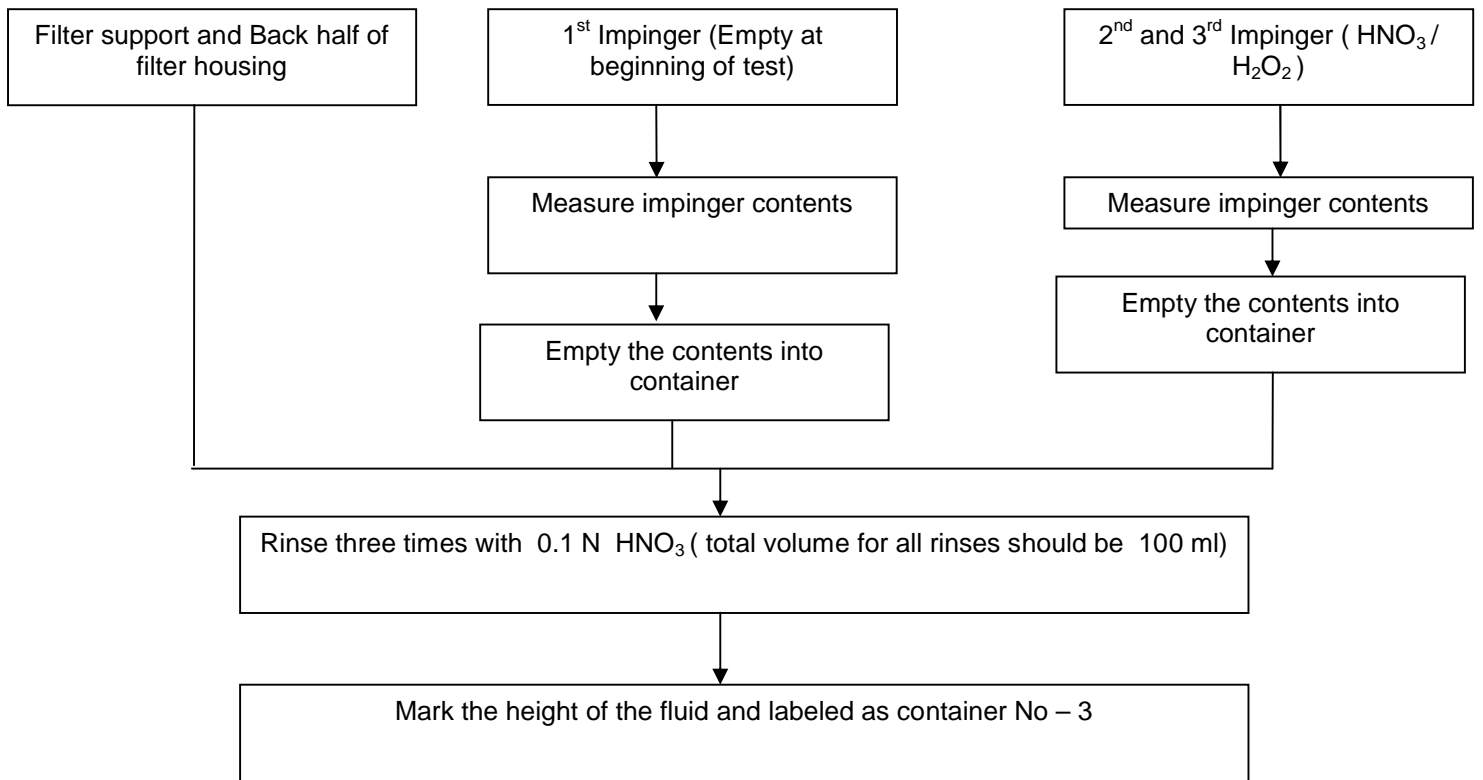

Figure -2.1: Sample Recovery Scheme for Filter support and Back half of filter housing, 1st(Empty) , 2nd ,3rd Impinger (HNO₃ /H₂O₂)

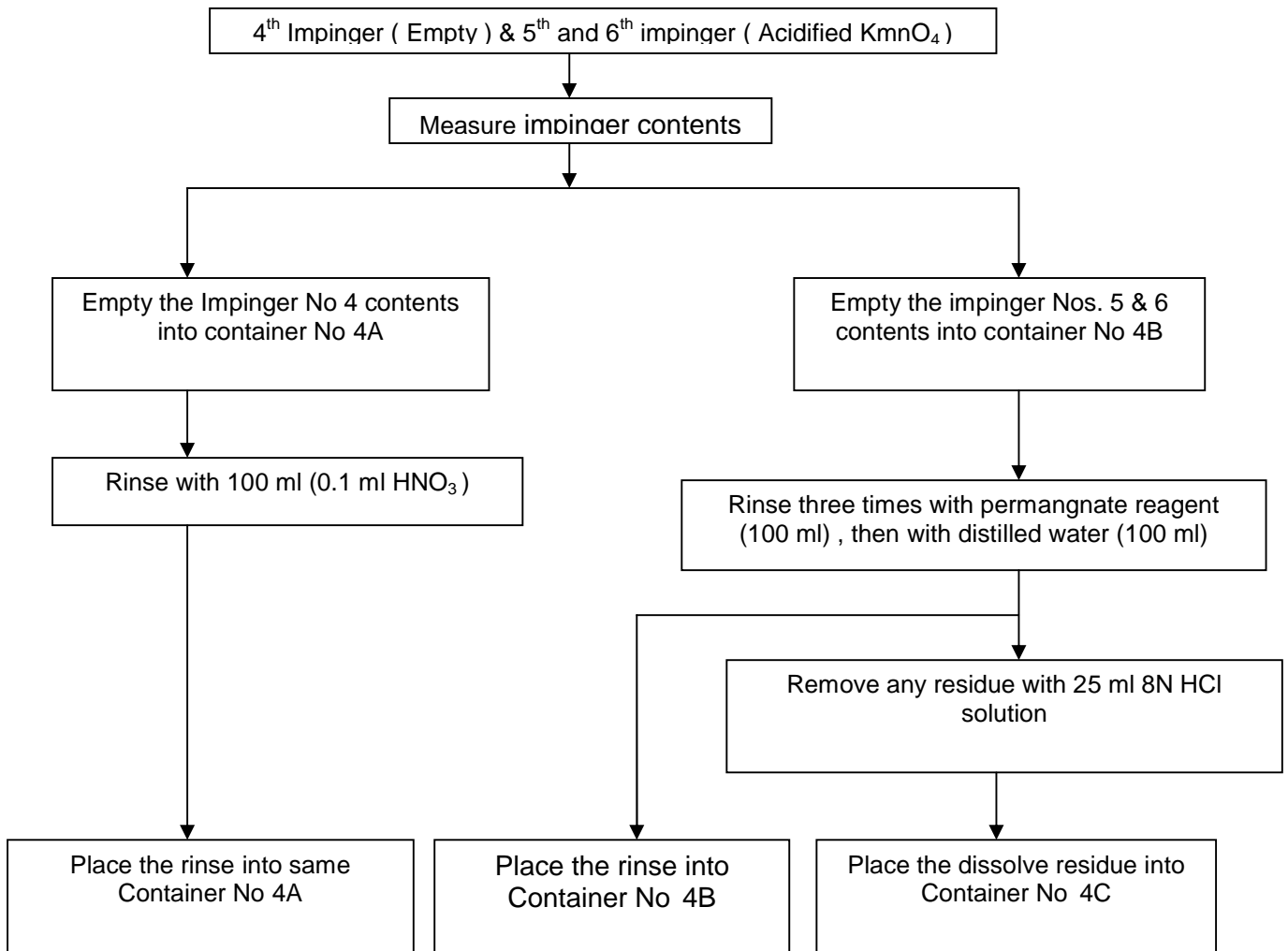

Figure – 2.2: Sample Recovery Scheme 4th Impinger (Empty) & 5th and 6th Impinger (Acidified KmnO₄)

Table – 2
Sample detail sheet

Industry Name & Address:
Date & Time of Sampling:

Container No	Sample Information	Volume / weight of the sample	Remarks
Container No. 1	Filter and any particulate matter or filter fiber that adhere to the filter holder gasket keep them into container no 1.		
Container No. 2	Rinse probe nozzle and fitting, liner and nozzle, front half of filter housing by 100ml of 0.1N HNO ₃ Place this rinses in Container no 2		
Container No 3	Solutions of 1 through 3 impingers pour it in container 3. Clean each of the first three impingers, the filter support, the back half of the filter housing, and connecting glassware by thoroughly rinsing with exactly 100 ml of 0.1N HNO ₃ , pour this rinses in the same container.		
Container No. 4A	Liquid of impinger No 4 as well as rinsing solution (100 ml of 0.1N HNO ₃ .) of the same impinger keep in the container No 4A.		
4B	It contains solution of both the 5 th & 6 th Impingers (Acidifying permanganate impinger) as well as rinsing solution (100 ml of fresh acidified KMnO ₄ & 100 ml of distilled water) of same impingers.		
4C	If deposits remain in the 5 th & 6 th Impingers, wash them with exactly 25 ml 8N HCl & pour this washing liquid into container No 4C containing 200 ml of water.		
Container No. 5	Note the color of the indicating silica gel and transfer the silica gel from its impinger to container No 5.		
Container No. 6A	Keep blank of 0.1 N HNO ₃ (used in the sample recovery process) into container No 6A.		
Container No. 6B	Water Blank (water used for the sample recovery): Keep water blank into container No 6B.		
Container No. 7	Keep blank of Nitric acid impinger reagent (5 Percent HNO ₃ /10 Percent H ₂ O ₂) into the Container No 7		
Container No. 8	Blank of Acidified KMnO ₄ impinger solution pour in to container No 8		
Container No. 9	Keep blank of 8 N HCl (sample recovery reagent) in to Container No. 9		
Container No. 10	Sample Filter Blank i.e unused filter from the same lot as the sampling filters.		

Note: volume of the blank subjected, to be decided according to the volume of sample (to be considered for the analysis).

**Table - 3
Field Data Sheet**

Name & Address
Date & time of Sampling
Ambient Temperature °C
Barometric Pressure (mm mercury column)
Moisture in the flue gas (%) flue gas composition (CO₂ %, O₂ %, N₂)
Filter No and weight (Initial as well as Final)

Travers Point	Δ P (mm)	Ts (°K)	Ps	Us (m/s)	Qs (m ³ /hr)	Rs (LPM)	P _m		Rm (LPM)	Time (min)	DGM (m ³)		Vstd (Nm ³)
							P _{m0}	P _{m1}			Initial	Final	

Δ P = Stack Gas Velocity Pressure, (mm water column), Ts = Stack temperature (°K),
Ps= Static pressure (mm water column), Us = Velocity of stack gas (m/s),
Qs = Volumetric Flow Rate/ Discharge, Rs = Flow at nozzle (LPM),
P_m = Vacuum Pressure Drop (mm mercury column),
Rm = Determination of sampling rate at gas meter. (LPM),
Vstd = Determination of volume of Gas Sampled

Other required information:

- Feed rate of hazardous waste
- The nature, composition and quantity of the material being incinerated during monitoring
- Installed and operating capacity of the incinerator
- No of sampling ports
- Internal diameter of the stack
- Nozzle size selected for sampling
- Pitot tube constant
- ID fan capacity
- Pollution control equipment installed and its status
- House keeping

Signature of sample collector

Verified by

Approved by

**Occupier/
Representative of
the incinerator
facility**

STANDARD OPERATING PROCEDURE (SOP) OF SAMPLE PREPARATION FOR ANALYSIS OF METALS AND NON METALS

1.0 Sample Preparation

Note the level of the liquid in each of the containers and determine if any sample was lost during shipment. A diagram illustrating sample preparation and analysis procedures for each of the sample train components is shown in Figure –3 and Figure – 3.1. By difference in weight and gas sample volume (Field data) calculate Particulate Matter concentration in $\mu\text{g}/\text{Nm}^3$.

Container No. 1 (Sample Filter).

If particulate emissions are being determined, first desiccate the filter and filter catch without added heat (do not heat the filters to speed the drying) and weigh to a constant weight

Option I – Microwave digestion

- Make pieces of filter papers/ thimbles (Do not use metallic scissor).
- Place the pieces of in the analyst's choice of either individual microwave pressure relief vessels or Parr^R Bombs.
- Add 6 ml of concentrated HNO_3 and 4 ml of concentrated HF to each vessel.
- In microwave heat the sample for 2- 3 min, then turn off the microwave for 2 to 3 minutes then heat for 2 – 3 minutes etc
- Continue this alteration until the 12 to 15 minutes.
- This procedure should comprise approximately 24 to 30 minutes at 600 watts.

Option II

- Place the pieces of thimbles in acid cleaned Teflon beaker add about 50 ml distilled water, add 6 ml of concentrated HNO_3 and 4 ml of concentrated HF to it.
- Place it on hot plate under fume extraction hood. Set the Temperature at 70°C . Continue to digest for 12 hrs.

Container No. 2 (Probe Rinse)

- Verify that the pH of this sample is 2 or lower. If it is not, acidify the sample by careful addition with stirring of concentrated HNO_3 to pH 2.
- Use water to rinse the sample into a Teflon beaker, and cover the beaker with a ribbed watch glass. Reduce the sample volume to approximately 20 ml by heating on a hot plate at a temperature below boiling.
- Add 6 ml of concentrated HNO_3 and 4 ml of concentrated HF to it. Place it on hot plate under fume extraction hood. Set the Temperature at 70°C continue the digestion for 12 hrs.
- If the sampling train includes an optional glass cyclone in front of the filter, prepare and digest the cyclone catch by the same way.

- Then combine the resultant sample directly with the acid digested portions of the filter prepared previously, acid rinse concentrate and cyclone catch concentrate (If done).
- Filter the combined sample using Whatman 41 filter paper. Dilute to 300 ml (or the appropriate volume for the expected metals concentration) with water.
- This diluted sample is "Analytical Fraction 1". Measure and record the volume of Analytical Fraction 1 to within 0.1 ml.
- Quantitatively remove a 50-ml aliquot and label as "Analytical Fraction 1B". Label the remaining 250-ml portion as "Analytical Fraction 1A". Analytical Fraction 1A is used for ICAP or AAS analysis for all desired metals except Hg.
- Analytical Fraction 1B is used for the determination of front-half Hg. This fraction should be treated with acid and KMnO_4 at 90°C for 2 hours. Excess KMnO_4 should be removed by using Hydroxylamine Hydrochloride before analysis of Hg.

Container No.3 (Impingers 1-3)

- Measure and record the total volume of this sample to within 0.5 ml, if the leakage found significant make up with fresh distilled water.
- Remove a 75- to 100-ml aliquot for Hg analysis and label the aliquot "Analytical Fraction 3B".
- Label the remaining portion as "Sample Fraction 3A".
- Verify that the pH of Sample Fraction 3A is 2 or lower. If necessary, use concentrated HNO_3 by careful addition and stirring to lower the pH upto 2.
- Use water to rinse Sample Fraction 3A into a beaker and then cover the beaker with a ribbed watch glass.
- Reduce Sample (3A) to approximately 20 ml by heating on a hot plate at a temperature just below boiling. Add 30 ml of 50 percent HNO_3 , and heat for 30 minutes on a hot plate to just below boiling. Add 10 ml of 3 percent H_2O_2 and heat for 10 more minutes. Add 50 ml of hot water, and heat the sample for an additional 20 minutes.
- Cool, filter the sample, and dilute to 150 ml (or the appropriate volume for the expected metals concentrations) with water. Analytical Fraction 3A is analyzed for all metals except Hg.
- Analytical fraction 3B will be digested separately with HCl and KMnO_4 at 90°C for two hours. Excess Permanganate should be removed by Hydroxylamine Hydrochloride before analysis in Cold Vapour AAS.

Container No. 4A (Empty impinger washing liquid with 0.1 N HNO₃), 4B (KMnO₄ /H₂ SO₄ absorbing solution of impinger 5 and 6), and 4C (8 N HCl rinse of impinger 5 and 6 for scaling of MnO₂)

- Keep the samples in Containers Nos. 4A, 4B, and 4C separate from each other. Measure and record the volume of 4A to within 0.5 ml. Concentrate the sample upto 20 ml on hot plate at below boiling temperature. Keep it separate.
- To remove any brown MnO₂ precipitate from the contents of Container No. 4B, filter its contents through Whatman 40 filter paper into a 500 ml volumetric flask, make up the volume with distilled water. This fraction is analytical fraction 4B.
- Save the filter for digestion of the brown MnO₂ precipitate. Place the saved filter into an appropriately sized vented container, which will allow release of any gases including chlorine formed when the filter is digested in a laboratory hood.
- Add 25 ml of 8 N HCl to the filter and allow to digest for a minimum of 24 hours at room temperature.
- Filter the contents of Container No. 4C through a Whatman 40 filter into a 500-ml volumetric flask. Then filter the resultant solution of the digestion of the brown MnO₂ from Container No. 4B through another Whatman 40 filter into the same 500-ml volumetric flask, finally dilute and mix well to volume with water. Discard the Whatman 40 filter. Mark this combined 500-ml dilute HCl solution as Analytical fraction 4C.
- So three samples will be generated in this section for Hg analysis. All these fractions shall be digested and concentrated to desired volume with HCl and KMnO₄ at 90 °C for two hours. Excess Permanganate should be removed by Hydroxylamine Hydrochloride before analysis in Cold Vapour AAS.

5.1 Sample Analysis

For each sampling train sample run, seven individual analytical samples are generated; two (Analytical fraction 1A and 3A) for all desired metals except Hg, and five for Hg (Analytical fraction 1B, 3B, 4A, 4B and 4C). A schematic identifying each sample container and the prescribed analytical preparation and analysis scheme is shown in Figure 3 and Figure 3.1 Blanks for all reagents used should be processed with samples in parallel.

6.0 CALCULATIONS

For Molecular weight determination, Stack gas velocity, Isokinetic Flow rate, Moisture content and parameters required for particulate emission calculation follow the formulae mentioned in method prescribed for particulate matter determination.

Dry Gas Volume. Using the data from this test, calculate $V_{m(std)}$, the dry gas sample volume at standard conditions as outline Correct the sample volume measured by the dry gas meter to standard conditions (25°C, 760 mm Hg or 68°F, 29.92in. Hg) by using following Equation. Where, Y is DGM Calibration Factor.

$$V_{mstd} = V_m Y \left[\frac{T_{std}}{T_m} \right] \left[\frac{P_{bar}}{P_{std}} \right] = K_1 Y V_m \left[\frac{P_{bar}}{T_m} \right]$$

Where:

$$K_1 = 0.3858 \text{ } ^\circ\text{K/mm Hg for metric units,} \\ = 17.64 \text{ } ^\circ\text{C/in. Hg for English units}$$

P_{bar} = Barometric pressure at the exit orifice of the DGM, mm Hg (in. Hg).

P_{std} = Standard absolute pressure, 760 mm Hg (29.92 in. Hg).

T_m = Average DGM absolute temperature, °K (°C).

T_{std} = Standard absolute temperature, 293°K

Y = Dry gas meter calibration factor

$V_{m(std)}$ = Dry gas volume measured by the dry gas meter, corrected to standard conditions, Nm³

V_m = {Sampling rate in gas channel (LPM) X duration (Minutes)} / 1000 m³.

Calculate all the seven fraction (2 for other metals and 5 for mercury) in mass of individual elements following the formula

Metals (Except Hg) in Source Sample.

$$M_x = C_x (\text{ppm}) * D * V_{ds}$$

where:

M_x = Total mass of each metal in μg .

C_x = Concentration of metal in respective Fraction as read from the standard curve in $\mu\text{g/ml}$ (ppm) after respective blank subtraction

D = Dilution Factor

V_{ds} = Total volume of digested sample solution in Analytical Fraction ml.

M_x values calculated for fraction 1A and 3A should be added individually to represent total mass for each metals except Hg. The concentration emitted from stack would be calculated as below.

$$\{M_x(1A) + M_x(3A)\} * 10^{-3} / V_{m(\text{std})} \quad \text{mg/NM}^3$$

Similarly for Hg

$$\{M_x(1B) + M_x(3B) + M_x(4A) + M_x(4B) + M_x(4C)\} * 10^{-3} / V_{m(\text{std})} \quad \text{mg/NM}^3$$

Note: Report the concentration as corrected at 11% O_2 (as mentioned in the method for PM determination)

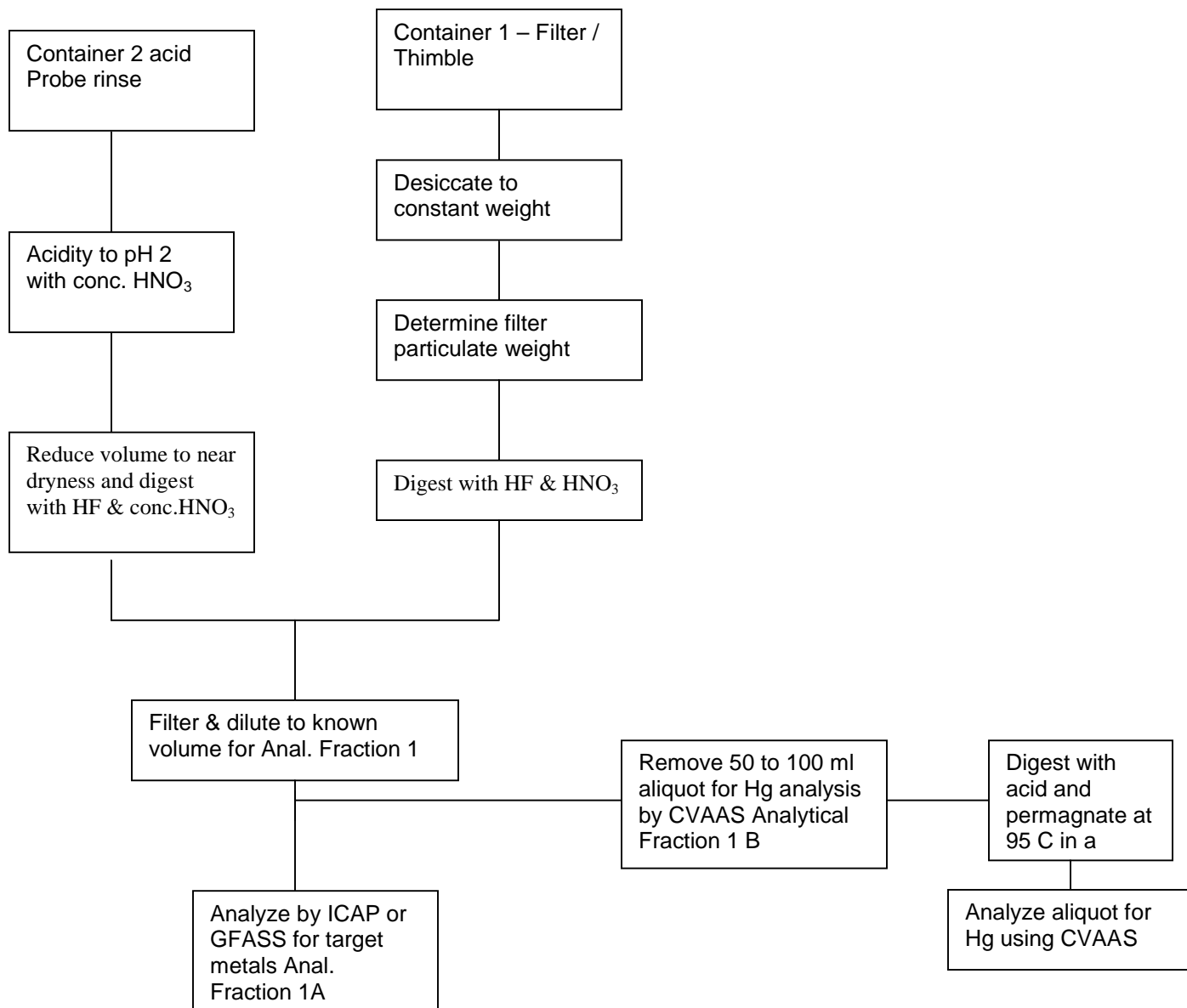

Fig 3: Sample Preparation and Analysis Scheme.

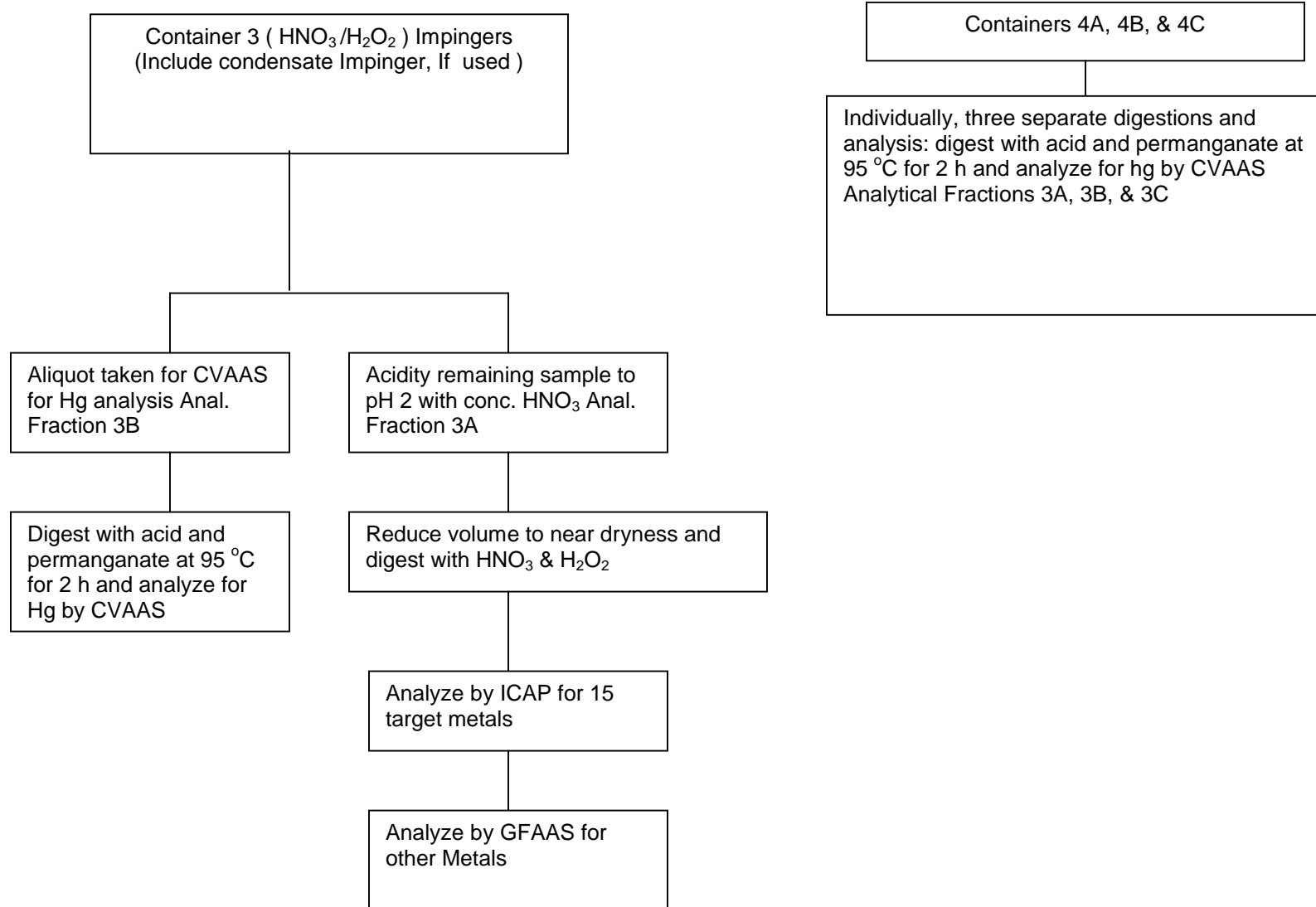

Fig 3.1: Sample Preparation and Analysis Scheme.

7.0 REFERENCES

1. Method 303F in Standard Methods for the Examination of Water Wastewater, 15th Edition, 1980. Available from the American Public Health Association, 1015 18th Street N.W., Washington, D.C. 20036.
2. EPA Methods 6010, 6020, 7000, 7041, 7060, 7131, 7421, 7470, 7740, and 7841, Test Methods for Evaluating Solid Waste: Physical/Chemical Methods. SW-846, Third Edition, November 1986, with updates I, II, IIA and IIB. Office of Solid Waste and Emergency Response, U. S. Environmental Protection Agency, Washington, D.C. 20460.
3. EPA Method 200.7, Code of Federal Regulations, Title 40, Part 136, Appendix C. July 1, 1987.
4. EPA Methods 1 through 5, Code of Federal Regulations, Title 40, Part 60, Appendix A, July 1, 1991.
5. EPA Method 101A, Code of Federal Regulations, Title 40, Part 61, Appendix B, July 1, 1991.

CHAPTER – 7

DETERMINATION OF POLYCHLORINATED DIBENZO-P-DIOXINS AND POLYCHLORINATED DIBENZOFURANS

**Determination of Polychlorinated Dibenzo-p-dioxins and Polychlorinated
Dibenzofurans
(PART- I)**

1.0 PRINCIPLE

A sample is withdrawn isokinetically from the gas stream and collected in the sample probe, on a glass fiber filter, and on a packed column of adsorbent material. The sample cannot be separated into a particle and vapor fraction. The PCDD's and PCDF's are extracted from the sample, separated by high resolution gas chromatography (HRGC), and measured by high resolution mass spectrometry (HRMS).

2.0 APPLICABILITY

This method is applicable to the determination of emissions of polychlorinated dibenzo-p-dioxins (PCDD's) and polychlorinated dibenzofurans (PCDF's) from stationary sources.

3.0 APPARATUS

3.1 Sampling

A schematic of the sampling train is shown in Figure -1. Sealing greases may not be used in assembling the train.

Table- 1: Apparatus for sampling

S. No	Apparatus	Description
1	Probe	Glass probe or stainless steel probe with glass liner
2	Nozzle	The nozzle shall be made of nickel, nickel-plated stainless steel, quartz, or borosilicate glass.
3	Sample Transfer Lines	The sample transfer lines, if needed, shall be heat traced, heavy walled TFE (½ in. OD with 1/8 in. wall) with connecting fittings that are capable of forming leak free, vacuum-tight connections without using sealing greases. The line shall be as short as possible and must be maintained at 120°C.
4	Condenser	Glass, coil type with compatible fittings. A schematic diagram is shown in Figure –2
5	Water Bath	Thermostatically controlled to maintain the gas temperature exiting the condenser at 20 - 25°C. Ice water with a recirculation pump may also be used to bring down the temperature at desired level
6	Adsorbent Module	Glass container to hold the solid adsorbent. A schematic diagram is shown in Figure - 2. Other physical configurations

		<p>of the resin trap/condenser assembly are also acceptable. The connecting fittings shall form leak-free, vacuum tight seals. No sealant greases shall be used in the sampling train. A coarse glass frit is included to retain the adsorbent.</p>
--	--	---

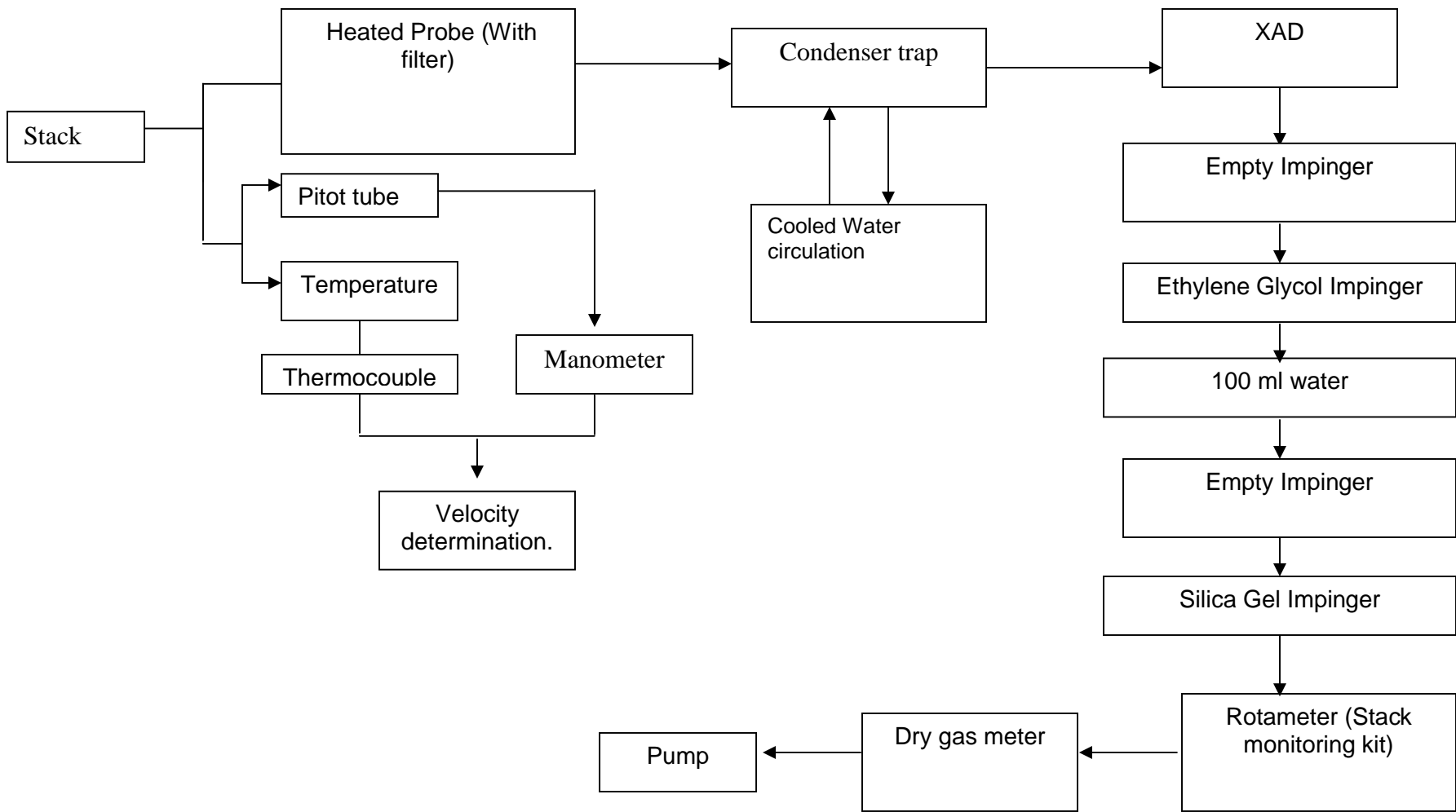

Figure 1: Proposed sampling train of Dioxins and Furans

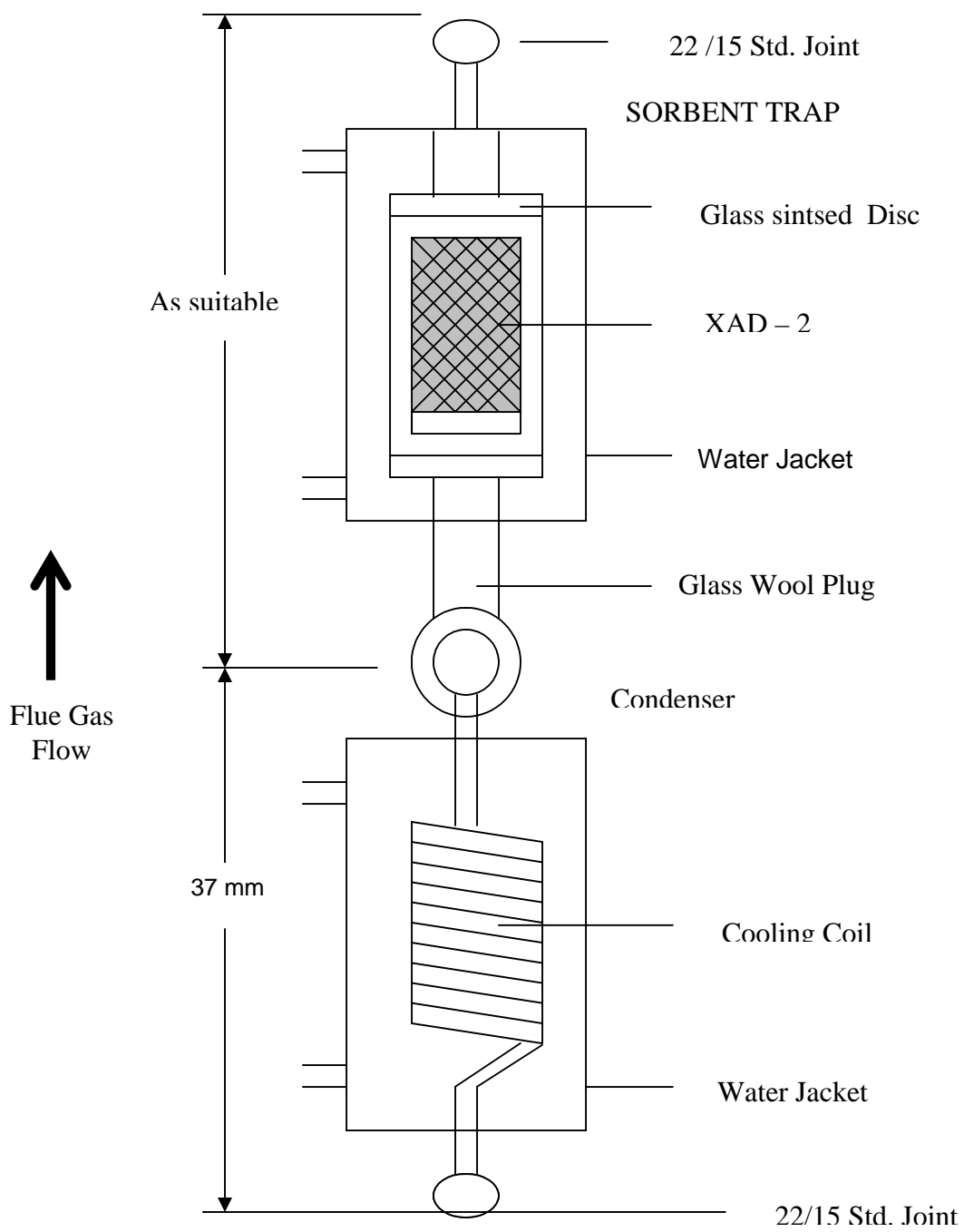

Figure 2: Condenser and Absorbent Trap

3.2 Materials for Pre-sampling laboratory activities

- Soxhlet Extraction Apparatus - Capable of holding 43 x 123 mm extraction thimbles.
- Extraction Thimble - Glass, precleaned cellulosic, or glass fiber.
- Pasteur Pipettes - For preparing liquid chromatographic columns.
- Reactive-vials - Amber glass, 2-mL, silanized prior to use.
- Rotary Evaporator - Buchi/Brinkman RF-121 or equivalent.
- Nitrogen Evaporative Concentrator - N-Evap Analytical Evaporator Model III or equivalent
- Hot air Oven- At least two (1 upto 250 °C and 1 upto 400 °C)
- Analytical Balance To measure within 0.1 mg.

4.0A REAGENT (for sampling)

4.1 Filters Glass fiber filters (Thimbles), without organic binder

4.1.1 Precleaning

All filters shall be cleaned before their initial use. Place a glass extraction thimble and 1 g of silica gel and a plug of glass wool into a Soxhlet apparatus, charge the apparatus with toluene, and reflux for a minimum of 3 hours. Remove the toluene and discard it, but retain the silica gel. Place no more than 50 filters in the thimble onto the silica gel bed and top with the cleaned glass wool. Charge the Soxhlet with toluene and reflux for 16 hours. After extraction, allow the Soxhlet to cool, remove the filters, and dry them under a clean nitrogen (N₂) stream. Store the filters in a glass petri dish sealed with Teflon tape.

4.2 Adsorbent resin - Amberlite XAD-2 resin.

4.2.1 Cleaning

Procedure may be carried out in a giant Soxhlet extractor. An all-glass filter thimble containing an extra-coarse frit is used for extraction of XAD-2. The frit is recessed 10-15 mm above a crenelated ring at the bottom of the thimble to facilitate drainage. The resin must be carefully retained in the extractor cup with a glass wool plug and a stainless steel ring because it floats on methylene chloride. This process involves sequential extraction in the following order.

Table - 2: Cleaning reagent

S. No	Solvent	Procedure
1	Water	Initial Rinse: Place resin in a beaker, rinse once with water, and discard. Fill with water, let stand overnight, and discard.
2	Water	Extract with water for 8 hours.
3	Methanol	Extract for 22 hours.
4	Methylene Chloride	Extract for 22 hours.
5	Toluene	Extract for 22 hours

4.2.2 Drying column - Pyrex pipe, 10.2 cm ID by 0.6 m long, with suitable retainers.

4.2.2.1 Procedure

The adsorbent must be dried with clean inert gas. Liquid nitrogen from a standard commercial liquid nitrogen cylinder has proven to be a reliable source for large volumes of gas free from organic contaminants. Connect the liquid nitrogen cylinder to the column by a length of cleaned copper tubing, 0.95 cm ID, coiled to pass through a heat source. A convenient heat source is a water-bath heated from a steam line. The final nitrogen temperature should only be warm to the touch and not over 40°C. Continue flowing nitrogen through the adsorbent until all the residual solvent is removed. The flow rate should be sufficient to gently agitate the particles, but not so excessive as to cause the particles to fracture.

4.2.3 Quality control check - The adsorbent must be checked for residual toluene prior to use.

4.2.3.1 Extraction - Weigh a 1.0 g sample of dried resin into a small vial, add 3 mL of toluene, cap the vial, and shake it well.

4.2.3.2 Analysis - Inject a 2 :l sample of the extract into a gas chromatograph operated under the following conditions:
Column: 6 ft x 1/8 in stainless steel containing 10 percent OV-101™ on 100/120 Supelcoport.
Carrier Gas: Helium at a rate of 30 mL/min.
Detector: Flame ionization detector operated at a sensitivity of 4 x 10⁻¹¹ A/mV.
Injection Port Temperature: 250°C.
Detector Temperature: 305°C.
Oven Temperature: 30°C for 4 min; programmed to rise at 40°C/min until it reaches 250°C; return to 30°C after 17 minutes.

Compare the results of the analysis to the results from the reference solution. Prepare the reference solution by injecting 2.5 :l of methylene chloride into 100 mL of toluene. This corresponds to 100 :g of methylene chloride per g of adsorbent. The maximum acceptable concentration is 1000 :g/g of adsorbent. If

the adsorbent exceeds this level, drying must be continued until the excess methylene chloride is removed.

4.2.4 Storage - The adsorbent must be used within 4 weeks of cleaning. After cleaning, the adsorbent may be stored in a wide mouth amber glass container with a Teflon-lined cap or placed in glass adsorbent modules tightly sealed with glass stoppers. If precleaned adsorbent is purchased in sealed containers, it must be used within 4 weeks after the seal is broken.

4.3 Glass Wool - Cleaned by sequential immersion in three aliquots of methylene chloride, dried in a 110°C oven, and stored in a methylene chloride-washed glass container with a Teflon-lined screw cap.

4.0 B REAGENT (for sample recovery)

- Solvents and Chemicals
- Acetone - Pesticide quality.
- Methylene Chloride - Pesticide quality.
- Toluene - Pesticide quality.
- Hexane - Pesticide grade.
- Methylene Chloride - Pesticide grade.
- Benzene - Pesticide grade.
- Ethyl Acetate
- Ethylene Glycol
- Methanol - Pesticide grade.
- Toluene - Pesticide grade.
- Nonane - Pesticide grade.
- Cyclohexane - Pesticide Grade.
- Nitrogen - Ultra high purity.
- Hydrogen - Ultra high purity.
- Surrogate (Sampling) Standard Solution - Prepare a stock mixed standard solution containing the isotopically labelled PCDF's listed in Table 1. Perform spiking desired mass of these congeners considering 10 m³ dry gas volume resulting 0.1 ng TEQ/m³ in XAD – 2 adsorbent cartridges. The possible volume and mass of labelled congeners are shown in Table - 3

Table - 3: Surrogate (Sampling) Standards

Labelled Isomers	Minimum spiking volume	Maximum mass in picograms
¹³ C ₁₂ -1,2,3, 7,8-PeCDF	100 µL	400
¹³ C ₁₂ -1,2,3, 7,8,9-HxCDF		400
¹³ C ₁₂ -1,2,3,4, 7,8,9-HpCDF		800

5.0 PROCEDURE

5.1 Pre-Sampling Preparation

- **Cleaning Glassware** - All glass components of the train upstream of and including the adsorbent module, shall be cleaned as described in Section 3A of the "Manual of Analytical Methods for the Analysis of Pesticides in Human and Environmental Samples." Special care shall be devoted to the removal of residual silicone grease sealants on ground glass connections of used glassware. Any residue shall be removed by soaking the glassware for several hours in a chromic acid cleaning solution prior to cleaning as described above.
- **Loading of Adsorbent Trap** - The traps must be loaded in a clean area to avoid contamination. They may not be loaded in the field. Fill a trap with 20 to 40 g of XAD-2. Follow the XAD-2 with glass wool and tightly cap both ends of the trap. Add 100 µL of the surrogate standard solution to each trap.
- **Sampling Train** - It is suggested that all components (glass parts) be maintained according to the procedure described in APTD-0576.
- **Silica Gel** - Weigh several 200 to 300 g portions of silica gel in air tight containers to the nearest 0.5 g. Record the total weight of the silica gel plus container, on each container. As an alternative, the silica gel may be weighed directly in its impinger or sampling holder just prior to sampling.
- **Filter / Thimbles** Check each filter against light for irregularities and flaws or pinhole leaks. Pack the filters/thimbles in a clean glass container.

5.2 Sampling

For source emission monitoring of dioxins and furans, an intricate flue gas sampling train and procedures are required to be adopted. The integrated stack gas sampling is iso- kinetically withdrawn from selected traverse points along the stack cross-section. Semi- volatile organic compounds associated with particulate matter are collected in the front- half components of the sampling train. Semi- volatile organic compounds not collected by high efficiency glass or quartz fiber are adsorbed on porous, polymeric resin, Amberlite XAD-2. The borosilicate or quartz liner, encased in a stainless steel tube is required to perform stack monitoring. This stainless steel tube is capable of maintaining the exit gas temperature at 120 ± 14°C or at required

temperature necessary to prevent condensation during sampling. The complexity of this method is such that, in order to obtain reliable results, testers and analysts should be trained and experienced with the procedures.

5.2.1 Preliminary Determinations

Determine the stack pressure, temperature, leak check and isokinetic velocity, volumetric flow rate, flow at nozzle as well as calculate sampling rate at the gas meter, volume of gas sampled during sampling as described in the SOP of the particulate matter

5.2.2 Sampling train components

- Probe assembly – The borosilicate or quartz liner, encased in a stainless steel tube is required to perform stack monitoring. This stainless steel tube is capable of maintaining the exit gas temperature at $120 \pm 14^{\circ}\text{C}$ or at required temperature necessary to prevent condensation during sampling.
- Condenser with condensate trap.
- Adsorbent Trap - The trap must be loaded in a clean area to avoid contamination. They may not be loaded in the field. Fill a trap with 20 to 40 g of XAD.
- Silica Gel - Weigh several 200 to 300 g portions of silica gel in air tight containers to the nearest 0.5 g. Record the total weight of the silica gel plus container, on each container. As an alternative, the silica gel may be weighed directly in its impinger or sampling holder just prior to sampling.
- Filter - Check each filter against light for irregularities and flaws or pinhole leaks.
- Pack the filters flat in a clean glass container.

5.2.3 Preparation of Collection Train

During preparation and assembly of the sampling train, keep all train openings where contamination can enter, sealed until sampling is about to begin.

Place approximately 100 mL of ethylene glycol and 100 ml water in the second and third impingers respectively, leave the first and fourth impingers empty, and transfer approximately 200 to 300 g of preweighed silica gel from its container to the fifth impinger.

Place the silica gel container in a clean place for later use in the sample recovery. Alternatively, the weight of the silica gel plus the fifth impinger may be determined to the nearest 0.5 g and recorded.

Assemble the sampling train as shown in Figure- 1

Turn on the adsorbent module and condenser coil recirculating pump and begin monitoring the adsorbent module gas entry temperature. Ensure proper sorbent gas entry temperature before proceeding and before sampling is initiated. It is extremely important that the XAD-2 adsorbent resin temperature never exceed

50°C because thermal decomposition will occur. During testing, the XAD-2 temperature must not exceed 20°C for efficient capture of the PCDD's and PCDF's.

5.3 Sample Recovery

Proper cleaning procedure begins as soon as the probe is removed from the stack at the end of the sampling period. Seal the nozzle end of the sampling probe with Teflon tape or aluminum foil. When the probe can be safely handled, wipe off all external particulate matter near the tip of the probe. Remove the probe from the train and close off both ends with aluminum foil. Seal off the inlet to the train with Teflon tape, a ground glass cap, or aluminum foil.

Transfer the probe and impinger assembly to the cleanup area. This area shall be clean and enclosed so that the chances of losing or contaminating the sample are minimized. Smoking, which could contaminate the sample, shall not be allowed in the cleanup area.

Inspect the train prior to and during disassembly and note any abnormal conditions, e.g., broken filters, colored impinger liquid, etc. Treat the samples as follows:

- Container No. 1 - Either seal the filter holder or carefully remove the filter from the filter holder and place it in its identified container. Do not place the filter in aluminum foil. Use a pair of cleaned tweezers to handle the filter. If it is necessary to fold the filter, do so such that the particulate cake is inside the fold. Carefully transfer to the container any particulate matter and filter fibers which adhere to the filter holder gasket, by using a dry inert bristle brush and a sharp-edged blade. Seal the container.
- Adsorbent Module - Remove the module from the train, tightly cap both ends, label it, and store it on ice for transport to the laboratory.
- Container No. 2 - Quantitatively recover material deposited in the nozzle, probe transfer lines, the front half of the filter holder, and the cyclone, if used, first, by brushing while rinsing three times with acetone and then, by rinsing the probe three times with methylene chloride. Collect all the rinses in Container No. 2. Rinse the back half of the filter holder three times with acetone. Rinse the connecting line between the filter and the condenser three times with acetone. Soak the connecting line with three separate portions of methylene chloride for 5 minutes each. If using a separate condenser and adsorbent trap, rinse the condenser in the same manner as the connecting line. Collect all the rinses in Container No. 2 and mark the level of the liquid on the container.
- Container No. 3 - Repeat the methylene chloride-rinsing followed by toluene rinse. Collect the rinses in Container No. 3 and mark the level of the liquid on the container.
- Container No. 4 – Liquid of Ethylene glycol trap is collected in 4th container with methylene chloride wash

- Impinger Water - Measure the liquid in the first four impingers to within 1 mL by using a graduated cylinder or by weighing it to within 0.5 g by using a balance. Record the volume or weight of liquid present. This information is required to calculate the moisture content of the effluent gas. Discard only the water fraction after measuring and recording the volume or weight.
- Silica Gel - Note the color of the indicating silica gel to determine if it has been completely spent and make a mention of its condition. Transfer the silica gel from the fifth impinger to its original container and seal.

6.0 CALCULATIONS

For Molecular weight determination, Stack gas velocity, Isokinetic Flow rate, Moisture content and parameters required for particulate emission calculation follow the formulae mentioned in method prescribed Particulate matter determination.

Dry Gas Volume. Using the data from this test, calculate V , the dry gas sample volume at standard conditions $m(std)$ as outline Correct the sample volume measured by the dry gas meter to standard conditions (25°C, 760 mm Hg or 68°F, 29.92in. Hg) by using following equation. Where, Y is DGM Calibration Factor.

$$V_{mstd} = V_m Y \left[\frac{T_{std}}{T_m} \right] \left[\frac{P_{bar}}{P_{std}} \right] = K_1 Y V_m \left[\frac{P_{bar}}{T_m} \right]$$

Where:

K_1 = 0.3858 °K/mm Hg for metric units,
= 17.64 °C/in. Hg for English units

P_{bar} = Barometric pressure at the exit orifice of the DGM, mm Hg (in. Hg).

P_{std} = Standard absolute pressure, 760 mm Hg (29.92 in. Hg).

T_m = Average DGM absolute temperature, °K (°c).

T_{std} = Standard absolute temperature, 293°K

Y = Dry gas meter calibration factor

$V_{m(std)}$ = Dry gas volume measured by the dry gas meter, corrected to standard conditions, Nm^3

V_m = {Sampling rate in gas channel (LPM) X duration (Minutes)} / 1000 m^3 .

(PART- II)

Analysis of pcdds and pcdfs

1.0 ANALYSIS

Total number of isomers in PCDDs and PCDFs family is 210. Among which 17 congeners are toxic having TEF (Toxic Equivalent Factors) values. It is not always possible for a Low resolution Mass Spectrometer to distinguish slight variation in mass of two ions generated from different isomers. For this reason High Resolution Mass Spectrometry with 10000 resolution is used for PCDDs and PCDFs analysis by which a change in mass at 4th decimal place can also be easily separated and identified. Ultra trace level analysis of dioxin and furans is based on isotopic dilution technique. It has unique quality control protocol and final results are always compensated for any loss during pre-treatment of sample.

1.1 Glassware Cleaning

All glassware shall be cleaned as required for any ultra trace organic analysis. All samples must be extracted within 30 days of collection and analyzed within 45 days of extraction.

1.2 Sample Extraction

Extraction System - Place an extraction thimble 1 g of silica gel, and a plug of glass wool into the Soxhlet apparatus, charge the apparatus with toluene, and reflux for a minimum of 3 hours. Remove the toluene and discard it, but retain the silica gel. Remove the extraction thimble from the extraction system and place it in a glass beaker to catch the solvent rinses.

Sample extraction:

1.2.1 XAD-2 Resin

- a) Outside XAD cartridge is wiped with Solvent Soaked paper
- b) About 500 ml solvent mixture (Toluene: Acetone 80 %+ 20%) is taken in a 1000 ml RB Boiling flask
- c) Teflon boiling chips are added in the flask.
- d) Two small glass tubes are placed at the bottom of Soxhlet separator.
- e) Insert the XAD upright.
- f) Spiked with 50 µL Internal Standard (Extraction Standard) on XAD-2 (Table – 4)
- g) XAD tube is plugged with glass stopper inside Soxhlet to prevent spill over.
- h) Flask and soxhlet are placed on heating mantle.
- i) Connect the same with condenser.
- j) Perform extraction for at least 20 hrs.
- k) Parallel Blank was taken without XAD tubes but with thimbles.

1.2.2 Filter / Thimble

- a) After completion of XAD extraction the filter part of the sample is taken. The glass cartridge is wiped with solvent soaked paper from outside if particulates are collected on glass wool.
- b) XAD Tubes are unloaded and archived until analysis is complete.
- c) Filter tubes are placed in same Soxhlet tube (in case of glass wool filter). Otherwise place the thimble in soxhlet tube.
- d) Add 10 ml HCL in 2% Ethylene-glyco-monoether to dissolve the inorganic part. Volume may vary depending on particulate load in sample.
- e) Spiked with 50 μ L Internal Standard (Extraction Standard).
- d) Plugged with glass stopper at the top to prevent spill over.
- e) Attached to the same solvent flask of previous day extract (XAD-2)
- F) Attached to condenser and extracted for 24 hrs.
- g) After extraction the sample (wool/ filter) was squeezed by forceps rinsed with Acetone (4 to five times) finally squeezed and removed. The tube is marked and archived.
- h) Flask is detached from soxhlet.

1.2.3 Liquid Condensate and rinses

- a) The liquid part of emission samples (Condensate and train rinsing samples) are extracted with solvent (liquid- liquid extraction)
- b) The samples are transferred to a separating funnel.
- c) First rinse was provided by sample rinse (Collected infield)
- d) Second rinse of each bottle with Acetone (100 ml)
- e) Third rinse of each bottle with Toluene (100 ml).
- f) Same volume of water including Acetone rinse volume is taken for blank extraction.
- g) The whole Solvent from the combined XAD / Filter/ wool is transferred to separator funnel.
- h) Shaken rigorously. Allowed to settle.
- i) Repeated the extraction for 3 times with Acetone + Toluene (20% + 80%)
- j) The whole solvent is taken and concentrated to about 50 ml. Transferred to 100 ml volumetric flask. Made up the volume with Toluene.
- k) 20 - 50 ml is taken for clean up. Rest 50 - 80 ml is archived for crosschecking if found necessary.
- l) This sample will join the pool (QC Sample) sample in next phase of processing i.e., Sample Clean up)

1.3 Sample Clean up

STEP – 1

- a) 20 ml or suitable aliquot is taken in 50 ml conical Rotary flask.
- b) Blank and Pool (Control) should run parallelly.
- c) 4 gms. H_2SO_4 / SiO_2 was added allowed to react for hours. Better to leave overnight.
- d) Prepared Multilayer (Figure- 3) Air gaps removed by N_2 blowing with Hexane.
- f) 100 ml conical Rotary flask taken placed below the column.

- h) Sample ($\text{SiO}_2 / \text{H}_2\text{SO}_4$ treated) are loaded to the column by pasture pipette. The solid parts are transferred first and then Solvent.
- i) 4×3 ml Hexane rinses provided.
- j) Final rinse with 30 ml Hexane.
- k) The collected Solvent is concentrated to 4 -5 ml.
- l) Sample are ready for Tandem/ ALOX clean up in next stage.

Step II

- A) Tandem Column Preparation
 - a) 250 mm Pasteur pipettes taken
 - b) plugged with glass wool(cotton)
 - c) 0.7 gm $\text{SiO}_2 / \text{H}_2\text{SO}_4$ was loaded.
 - d) 0.3 gm SiO_2 / Cs was loaded on top
- B) Alex Column Preparation
 - a) prepared Alex (Aluminum Oxide) column
 - b) 3.65- 3.70 gm Alumina oxide (hot) is loaded in plugged column.
 - c) Little (1.0 gm) Na_2SO_4 added on top
 - d) Both the column washed with Hexane under N_2 purging to remove air gaps
 - e) Tandem was placed at top of the Alex column.
 - f) Sample loaded directly on the top of tandem column.
 - g) 4 times rinse with 2ml Hexane in each time.
 - h) Tandem column is removed
 - i) 7 ml Hexane at the top of Alex column.
 - j) 6 ml Hexane: DCM (98 : 2) added on top of alumina column.
 - k) The whole waste discarded and sample collection flask is placed 50 ml conical rotary flask.
 - l) The PCDDs/DFs eluted with 25 ml Hexane.: DCM (1:1)
 - m) The elute is evaporated to dryness.
 - n) The sample is ready for Carbo pack column clean up.

STEP III

- a) 0.5 gm carbopack (Supeleo) was loaded in Carbo pack Column (10mm dia).
- b) Rinsed with Toluene under N_2 Purging.
- c) Washed with mixed Solvent - A (Di chloromethane :Methanol : Toluene : : 75 : 20 : 5)
- d) Washed with Solvent A was added to the Sample flask, Mixed well and Sample Loaded to the column.
- e) 3×2 ml washing with Solvent A.
- f) 1 ml Solvent - A is charged directly on top of the column.
- g) Loaded 0.5 ml DCM : Methanol : Toluene :: 75 :20: 5.
- h) Waste Discarded.
- i) PCDDs /Fs eluted with 60 ml Toluene, Collected in new wasted Rotary flask (100ml). The volume of, Toluene may vary according to the batch of Carbopack.
- j) The eluted Solvent evaporated to dryness.
- k) New Tandem Column Prepared (0.7 gm $\text{SiO}_2 / \text{H}_2\text{SO}_4$ + .39 m Cs/ SiO_2)
- l) Washed with Hexane under N_2 purging.
- m) 2 ml Hexane added in the dried Sample flask.
- n) Sample loaded to the tandem column.

- o) 4 x 2 ml Hexane rinse provided. Elute collected in 25 ml conical rotary flask.
- p) Flask dried under N₂ purging

STEP IV

- a) Vial insert are placed under N₂ Purging system
- b) 200 ml Hexane added to the dried flask.
- c) Sample transferred to insert by micro pipette tips (glass 100 ml)
- d) 3 rinses with 200 ul each provided (Hexane)
- e) Allowed to dry under N₂ Purging.
- f) 25 µL of Recovery (syringe / Injection / performance) Standard (Table- 5) is added to the insert.
- g) Crimped the vials (marked)
- h) Ready for HRGC – HRMS Analysis.

Table - 4: Internal (Extraction) Standards

Labelled Isomers	Minimum Spiking volume	Maximum mass in picograms
¹³ C ₁₂ -2,3, 7,8-TCDF	50 µL (on XAD) + 50 µL (on Filter) = 100 µL	400
¹³ C ₁₂ -2,3, 7,8-TCDD		400
¹³ C ₁₂ -2,3, 4,7,8-PeCDF		400
¹³ C ₁₂ -1,2,3, 7,8-PeCDD		400
¹³ C ₁₂ -1,2,3, 4,7,8 -HxCDF		400
¹³ C ₁₂ -1,2,3, 6,7,8 -HxCDF		400
¹³ C ₁₂ -2,3, 4,6,7,8 -HxCDF		400
¹³ C ₁₂ -1,2,3, 4,7,8 -HxCDD		400
¹³ C ₁₂ -1,2,3, 6,7,8 -HxCDD		400
¹³ C ₁₂ -1,2,3,4, 6,7,8- HpCDF		800
¹³ C ₁₂ -1,2,3,4, 6,7,8- HpCDD		800
¹³ C ₁₂ -OCDF		800
¹³ C ₁₂ -OCDD		800

Table - 5: Recovery (Syringe / Injection / Performance) Standards

Labelled Isomers	Spiking volume	Maximum mass in picograms
¹³ C ₁₂ -1,2,3, 4 TCDD	25 µL	400
¹³ C ₁₂ -1,2,3, 7,8,9 -HxCDD		400

2.0 Analysis

Analyze the sample with a High Resolution Gas chromatograph coupled to a High Resolution Mass Spectrometer (HRGC-HRMS). 1-3 µL Sample extracts are first analyzed using the DB-5 capillary column to determine the concentration of each isomer of PCDD's and PCDF's (tetra-through octa-). If tetrachlorinated dibenzofurans are detected in this analysis, then analyze another aliquot of the sample in a separate run, using the DB-225 column to measure the 2,3,7,8 tetra-chloro

dibenzofuran isomer. Other column systems may be used, provided that the user is able to demonstrate using calibration and performance checks that the column system is able to meet the specifications.

(A) General Gas Chromatograph Operating Conditions.

- Injector - Configured for capillary column, splitless, 250 °C.
- Carrier Gas - Helium, 1-2 ml/min.
- Oven - Initially at 150 °C. Rise by at least 40 °C/min to 190 °C and then by a suitable ramp (X °C/min) up to 300 °C.

(B) High Resolution Mass Spectrometer.

- Resolution - 10,000 m/e.
- Ionization Mode - Electron impact.
- Source Temperature - 270°C (for Polar column)
- 280 °C (for non polar column)

Monitoring Mode - Selected ion monitoring. A list of the various ions to be monitored is presented in Table- 6 a (non polar column) and b (for polar column).

Table - 6a: Masses of ions monitored for determination using non-polar column

Group 1		Group 2		Group 3	
Ions	Mass in ME	Ions	Mass in ME	Ions	Mass in ME
TCDF	303.9016	PeCDF	339.8598	HxCDF	373.8208
TCDF	305.8988	PeCDF	341.8569	HxCDF	375.8179
TCDF- ¹³ C ₁₂	315.9419	PeCDF- ¹³ C ₁₂	351.9000	Lock Mass	380.9760
Lock Mass	316.9824	PeCDF- ¹³ C ₁₂	353.8970	check	3809760
check	316.9824	PeCDD	355.8547	Lock Mass	385.8610
Lock Mass	317.9389	PeCDD	357.8518	HxCDF- ¹³ C ₁₂	387.8581
TCDF - ¹³ C ₁₂	319.8965	Lock Mass	366.9792	HxCDF- ¹³ C ₁₂	389.8157
TCDD	321.8937	check	366.9792	HxCDD	391.8128
TCDD	331.9368	Lock Mass	367.8949	HxCDD	401.8559
TCDD - ¹³ C ₁₂	333.9339	PeCDD- ¹³ C ₁₂	369.8920	HxCDD- ¹³ C ₁₂	403.8530
TCDD - ¹³ C ₁₂		PeCDF- ¹³ C ₁₂		HxCDF- ¹³ C ₁₂	

...Continued Table - 6 a

Group 4		Group 5	
Ions	Mass in ME	Ions	Mass in ME
HpCDF	407.7818	OCDF	441.7428
HpCDF	409.7789	OCDF	443.7399
HpCDF- ¹³ C ₁₂	419.8220	OCDF - ¹³ C ₁₂	453.7831
HpCDF- ¹³ C ₁₂	421.8191	Lock Mass check	454.9728
HpCDD	423.7767	Lock Mass	454.9728
HpCDD	524.7739	OCDF - ¹³ C ₁₂	455.7801
Lock Mass check	430.9728	OCDD	457.7377
Lock Mass	430.9728	OCDD	459.7349
HpCDD- ¹³ C ₁₂	435.8169	OCDD - ¹³ C ₁₂	469.7780
HpCDD- ¹³ C ₁₂	437.8140	OCDD - ¹³ C ₁₂	471.7750

Table - 6b: Masses of ions monitored for determination using polar column

Group 1		Group 2	
Ions	Mass in ME	Ions	Mass in ME
TCDF	303.9016	HxCDF	373.8208
TCDF	305.8988	HxCDF	375.8179
TCDF- ¹³ C ₁₂	315.9419	HxCDF- ¹³ C ₁₂	385.8610
TCDF - ¹³ C ₁₂	317.9389	HxCDF- ¹³ C ₁₂	387.8581
TCDD	319.8965	HpCDF	407.7818
TCDD	321.8937	HpCDF	409.7789
TCDD - ¹³ C ₁₂	331.9368	HpCDF- ¹³ C ₁₂	419.8220
TCDD - ¹³ C ₁₂	333.9339	HpCDF- ¹³ C ₁₂	421.8191
PeCDF	339.8598	HpCDD	423.7767
PeCDF	341.8569	HpCDD	425.7739
PeCDF- ¹³ C ₁₂	351.9000	Lock Mass check	430.9728
PeCDF- ¹³ C ₁₂	353.8970	Lock Mass	430.9728
PeCDD	355.8547	HpCDD- ¹³ C ₁₂	435.8169
PeCDD	357.8518	HpCDD- ¹³ C ₁₂	437.8140
Lock Mass check	366.9792		441.7428
Lock Mass	366.9792	OCDF	443.7399
PeCDD- ¹³ C ₁₂	367.8949	OCDF	453.7831
PeCDD- ¹³ C ₁₂	369.8920	OCDF - ¹³ C ₁₂	455.7801
HxCDF	373.8208	OCDF - ¹³ C ₁₂	457.7377
HxCDF	375.8179	OCDD	459.7349
HxCDF- ¹³ C ₁₂	385.8610	OCDD	469.7780
HxCDF- ¹³ C ₁₂	387.8581	OCDD - ¹³ C ₁₂	471.7750
HxCDD	389.8157	OCDD - ¹³ C ₁₂	
HxCDD	391.8128		
HxCDD- ¹³ C ₁₂	401.8559		
HxCDF- ¹³ C ₁₂	403.8530		

Identification Criteria –The following identification criteria shall be used for the characterization of polychlorinated dibenzodioxins and dibenzofurans. The mass fragmentograms furnish both qualitative and quantitative information. A congener is characterised by mole mass, isotope ratio and retention time. The qualitative alignment of the measurement signals (peaks) is carried out by comparing retention times of those of internal reference substances and with the correct isotpoe ratio at a given mole mass M⁺, (M + 2)⁺ and (M + 4)⁺. The peak areas are in proportion to the injected mass of the substances.

1. The integrated ion-abundance ratio (M/M+2 or M+2/M+4) shall be within 15 percent of the theoretical value. The acceptable ion-abundance ratio should ranges (+15%) for the identification of chlorine-containing compounds.
2. The retention time for the analytes must be within 3 seconds of the corresponding ¹³C labeled internal standard or surrogate standard.
3. The monitored ions, for a given analyte, shall reach their maximum within 2 seconds of each other.
4. The identification of specific isomers that do not have corresponding ¹³C-labeled standards is done by comparison of the relative retention time (RRT) of the analyte to the nearest internal standard retention time with reference (i.e., within 0.005 RRT units) to the comparable RRT's found in the continuing calibration.
5. The signal to noise ratio for all monitored ions must be greater than 2.5.

6. The confirmation of 2, 3, 7, 8-TCDF shall satisfy all of the above identification criteria.

2.1 Quantification – The quantitative determination is performed according to the isotope dilution method. A known mass of extraction standard is added to the sample prior to the sample preparation. In the mass fragmentogram the areas of signals from the ¹³C₁₂ labelled internal standard are correlated with corresponding substances to be determined.

$$m_{i\ 12C} = \frac{m_{i\ 13C} * F_{i\ 12C}}{RRF_i * F_{i\ 13C}}$$

Where:

$m_{i\ 12C}$ – mass of native congener i

$m_{i\ 13C}$ – mass of corresponding ¹³C₁₂ labelled standard (congener) i added to the sample

$F_{i\ 12C}$ – Area of the peak of the native congener i (1 ion or sum of better two ions)

$F_{i\ 13C}$ – Area of the peak of the corresponding ¹³C₁₂ labelled standard (congener) i added to the sample

RRF_i – Relative Response Factor of the native congener i relative to the corresponding ¹³C₁₂ labelled congener i.

For some native congeners corresponding ¹³C₁₂ labelled congeners are used as sampling or recovery standards and so can not be used for calculation of RRF. In these cases a congener with similar properties are used. The quantification scheme for PCDDs/PCDFs in emission samples is presented in Table – 7

Table - 7: Quantitation Scheme for PCDDs and PCDFs

Target Analyte having TEF	Corresponding Extraction (Internal) Standards
2,3, 7,8-TCDD	¹³ C ₁₂ -2,3, 7,8-TCDD
1,2,3, 7,8-PeCDD	¹³ C ₁₂ -1,2,3, 7,8-PeCDD
1,2,3, 4,7,8 –HxCDD	¹³ C ₁₂ -1,2,3, 4,7,8 -HxCDD
1,2,3, 6,7,8 –HxCDD	¹³ C ₁₂ -1,2,3, 6,7,8 -HxCDD
1,2,3, 7,8,9 -HxCDD	¹³ C ₁₂ -1,2,3, 6,7,8 -HxCDD
1,2,3,4, 6,7,8-HpCDD	¹³ C ₁₂ -1,2,3,4, 6,7,8-HpCDD
OCDD	¹³ C ₁₂ -OCDD
2,3, 7,8-TCDF	¹³ C ₁₂ -2,3, 7,8-TCDF
1,2,3, 7,8-PeCDF	¹³ C ₁₂ -2,3, 4,7,8-PeCDF
2,3, 4,7,8-PeCDF	¹³ C ₁₂ -2,3, 4,7,8-PeCDF
1,2,3, 4,7,8 –HxCDF	¹³ C ₁₂ -1,2,3, 4,7,8 -HxCDF
1,2,3, 6,7,8 –HxCDF	¹³ C ₁₂ -1,2,3, 6,7,8 –HxCDF
1,2,3, 7,8,9 –HxCDF	¹³ C ₁₂ -2,3, 4,6,7,8 –HxCDF
2,3, 4,6,7,8 –HxCDF	¹³ C ₁₂ -2,3, 4,6,7,8 –HxCDF
1,2,3,4, 6,7,8-HpCDF	¹³ C ₁₂ -1,2,3,4, 6,7,8-HpCDF
1,2,3,4, 7,8,9-HpCDF	¹³ C ₁₂ -1,2,3,4, 6,7,8-HpCDF
OCDF	¹³ C ₁₂ -OCDF

2.2 CALIBRATION

The instrument calibration standards shall contain all congeners of native standards (target analytes), Internal (Extraction) Standards, Surrogate (Sampling / Recovery standards) and Recovery (Syringe / Performance / Injection Standard)

2.2.1 Initial Calibration

Calibrate the GC/MS system using the set of five standards shown in Table - 8 The signal to noise ratio for the GC signal present in every selected ion current profile shall be greater than or equal to 2.5. The ion abundance ratios shall be within the control limits.

Table - 8: Mixed Calibration standard

Calibration mixture I	¹² C congener's concentration ng/μL	¹³ C congener's concentration ng/μL (in Sampling, Internal, Syringe Standard)
1,2,3,4 – TCDD (Recovery/Syringe Standard)	----	10
2,3, 7,8-TCDD	0.5	10
1,2,3, 7,8-PeCDD	0.5	10
1,2,3, 4,7,8 –HxCDD	0.5	10
1,2,3, 6,7,8 –HxCDD	0.5	10
1,2,3, 7,8,9 -HxCDD	0.5	10
1,2,3,4, 6,7,8-HpCDD	1.0	20
OCDD	1.0	20
2,3, 7,8-TCDF	0.5	10
1,2,3, 7,8-PeCDF	0.5	10
2,3, 4,7,8-PeCDF	0.5	10
1,2,3, 4,7,8 –HxCDF	0.5	10
1,2,3, 6,7,8 –HxCDF	0.5	10
1,2,3, 7,8,9 –HxCDF	0.5	10
2,3, 4,6,7,8 –HxCDF	0.5	10
1,2,3,4, 6,7,8-HpCDF	1.0	20
1,2,3,4, 7,8,9-HpCDF	1.0	20
OCDF	1.0	20
Calibration mixture II	¹² C congener's concentration ng/μL	¹³ C congener's concentration ng/μL (in Sampling, Internal, Syringe Standard)
1,2,3,4 – TCDD (Recovery/Syringe Standard)	----	10
2,3, 7,8-TCDD	2.0	10
1,2,3, 7,8-PeCDD	2.0	10

1,2,3, 4,7,8 –HxCDD	2.0	10
1,2,3, 6,7,8 –HxCDD	2.0	10
1,2,3, 7,8,9 -HxCDD	2.0	10
1,2,3,4, 6,7,8-HpCDD	4.0	20
OCDD	4.0	20
2,3, 7,8-TCDF	2.0	10
1,2,3, 7,8-PeCDF	2.0	10
2,3, 4,7,8-PeCDF	2.0	10
1,2,3, 4,7,8 –HxCDF	2.0	10
1,2,3, 6,7,8 –HxCDF	2.0	10
1,2,3, 7,8,9 –HxCDF	2.0	10
2,3, 4,6,7,8 –HxCDF	2.0	10
1,2,3,4, 6,7,8-HpCDF	4.0	20
1,2,3,4, 7,8,9-HpCDF	4.0	20
OCDF	4.0	20
Calibration mixture III	¹² C congener's concentration ng/μL	¹³ C congener's concentration ng/μL (in Sampling, Internal, Syringe Standard)
1,2,3,4 – TCDD (Recovery/Syringe Standard)	----	10
2,3, 7,8-TCDD	10.0	10
1,2,3, 7,8-PeCDD	10.0	10
1,2,3, 4,7,8 –HxCDD	10.0	10
1,2,3, 6,7,8 –HxCDD	10.0	10
1,2,3, 7,8,9 -HxCDD	10.0	10
1,2,3,4, 6,7,8-HpCDD	20.0	20
OCDD	20.0	20
2,3, 7,8-TCDF	10.0	10
1,2,3, 7,8-PeCDF	10.0	10
2,3, 4,7,8-PeCDF	10.0	10
1,2,3, 4,7,8 –HxCDF	10.0	10
1,2,3, 6,7,8 –HxCDF	10.0	10
1,2,3, 7,8,9 –HxCDF	10.0	10
2,3, 4,6,7,8 –HxCDF	10.0	10
1,2,3,4, 6,7,8-HpCDF	20.0	20
1,2,3,4, 7,8,9-HpCDF	20.0	20
OCDF	20.0	20
Calibration mixture IV	¹² C congener's concentration ng/μL	¹³ C congener's concentration ng/μL (in Sampling, Internal, Syringe Standard)
1,2,3,4 – TCDD (Recovery/Syringe Standard)	----	10
2,3, 7,8-TCDD	30.0	10
1,2,3, 7,8-PeCDD	30.0	10

1,2,3, 4,7,8 –HxCDD	30.0	10
1,2,3, 6,7,8 –HxCDD	30.0	10
1,2,3, 7,8,9 -HxCDD	30.0	10
1,2,3,4, 6,7,8-HpCDD	60.0	20
OCDD	60.0	20
2,3, 7,8-TCDF	30.0	10
1,2,3, 7,8-PeCDF	30.0	10
2,3, 4,7,8-PeCDF	30.0	10
1,2,3, 4,7,8 –HxCDF	30.0	10
1,2,3, 6,7,8 –HxCDF	30.0	10
1,2,3, 7,8,9 –HxCDF	30.0	10
2,3, 4,6,7,8 –HxCDF	30.0	10
1,2,3,4, 6,7,8-HpCDF	60.0	20
1,2,3,4, 7,8,9-HpCDF	60.0	20
OCDF	60.0	20
Calibration mixture V	¹² C congener's concentration ng/μL	¹³ C congener's concentration ng/μL (in Sampling, Internal, Syringe Standard)
1,2,3,4 – TCDD (Recovery/Syringe Standard)	----	10
2,3, 7,8-TCDD	100.0	10
1,2,3, 7,8-PeCDD	100.0	10
1,2,3, 4,7,8 –HxCDD	100.0	10
1,2,3, 6,7,8 –HxCDD	100.0	10
1,2,3, 7,8,9 -HxCDD	100.0	10
1,2,3,4, 6,7,8-HpCDD	200.0	20
OCDD	200.0	20
2,3, 7,8-TCDF	100.0	10
1,2,3, 7,8-PeCDF	100.0	10
2,3, 4,7,8-PeCDF	100.0	10
1,2,3, 4,7,8 –HxCDF	100.0	10
1,2,3, 6,7,8 –HxCDF	100.0	10
1,2,3, 7,8,9 –HxCDF	100.0	10
2,3, 4,6,7,8 –HxCDF	100.0	10
1,2,3,4, 6,7,8-HpCDF	200.0	20
1,2,3,4, 7,8,9-HpCDF	200.0	20
OCDF	200.0	20

2.3 Daily Performance Check

- Calibration Check - Inject any level standard to the system. Calculate the relative response factor (RRF) for each compound and compare each RRF to the corresponding mean RRF obtained during the initial calibration. The analyzer performance is acceptable if the measured RRF's for the labeled and unlabeled compounds for the daily run are within the limits of the mean values of the method. In addition, the ion-abundance ratios shall be within the allowable control limits also. Next day calibration check is performed with next level

calibration standard and thus all the calibration levels are updated during routine run.

- Column Separation Check - Inject a solution of a mixture of PCDD's and PCDF's that documents resolution between 2,3,7,8-TCDD and other TCDD isomers. Resolution is defined as a valley between peaks that is less than 25 percent of the lower of the two peaks. Identify and record the retention time windows for each homologous series. Perform a similar resolution check on the confirmation column to document the resolution between 2,3,7,8 TCDF and other TCDF isomers.
- Lock Channels - Set mass spectrometer lock channels. Monitor the quality control check channels to verify instrument stability during the analysis.
- Recovery Rates – For the determination of recovery rates defined quantities of two ¹³C₁₂-labelled recovery (Injection/Syringe/performance) standards are added after cleanup and prior to injection. The recovery rates of remaining standards are determined via the response factor of appropriate standards which are externally quantified.
- Sampling Train Collection Efficiency Check – The purpose of ¹³C₁₂ labelled Recovery (Surrogate / Sampling) standards addition prior to the sampling is to check the possible presence of any apparatus or handling errors. The recovery rates of these standards generally lie between 50 – 100% independent of any type of plant. Less than 50% efficiency suspect systematic errors. The results shall never be corrected to 100% in any case for sampling standards. It is only performed for quality assurance in sampling.

The Surrogate (Sampling) standards are quantified against the appropriate extraction standards as given in Table – 9a following the calculation as

$$R_{i\ sa} = \frac{100 * m_{i\ ex} * Q_{i\ sa}}{RRF_i * m_{i\ sa} * Q_{i\ ex}}$$

Where:

- R_{i sa} – Recovery rate of the sampling standard i, in percent
- m_{i ex} – mass of extraction standard i added to the sample
- m_{i sa} – mass of sampling standard i added to the sample
- Q_{i sa} / Q_{i ex} – Response ratio of sampling standard i and relevant extraction standard in the sample
- RRF_i – Relative Response Factor of the sampling standard i relative to the corresponding extraction (internal) standard i.

Table - 9a: Calculation Scheme for the recovery rates of Surrogate (Sampling) Standards

Surrogate (Sampling) Standards	Internal (Extraction)
¹³ C ₁₂ -1,2,3, 7,8-PeCDF	¹³ C ₁₂ -2,3, 4,7,8-PeCDF
¹³ C ₁₂ -1,2,3, 7,8,9-HxCDF	¹³ C ₁₂ -2,3, 4,6,7,8 –HxCDF
¹³ C ₁₂ -1,2,3,4, 7,8,9-HpCDF	¹³ C ₁₂ -1,2,3,4, 6,7,8-HpCDF

Internal Standard Percent Recoveries - A group carbon-labeled PCDDs and PCDFs representing the tetra- through octachlorinated homologues, is added to every sample prior to extraction. The role of the internal standards is to quantify the native PCDD's and PCDF's present in the sample as well as to determine the overall method efficiency. Recoveries of the internal standards must be between 40 to 130 percent for the tetra-through hexachlorinated compounds while the range is 25 to 130 percent for the hepta- and octachlorinated homologues.

The Extraction (Internal) standards are quantified against the appropriate Recovery (Syringe / Injection / Performance) standards as given in Table - 9b following the calculation as

$$R_{i\text{ ex}} = \frac{100 * m_{i\text{ sy}} * Q_{i\text{ ex}}}{RRF_i * m_{i\text{ ex}} * Q_{i\text{ sy}}}$$

Where:

- $R_{i\text{ ex}}$ – Recovery rate of the extraction standard i, in percent
- $m_{i\text{ ex}}$ – mass of individual extraction standard i added to the sample
- $m_{i\text{ sy}}$ – mass of recovery (Syringe / Injection) standard i added to the sample
- $Q_{i\text{ ex}} / Q_{i\text{ sy}}$ – Response ratio of extraction standard i and relevant recovery (Syringe / Injection) standard in the sample
- RRF_i – Relative Response Factor of the extraction (internal) standard i relative to the corresponding recovery (Syringe / Injection) standard i.

Table - 9b: Calculation Scheme for the recovery rates of Internal (Extraction) Standards

Internal (Extraction) Standards	Quantitative relative (Syringe/Injection/Performance) Standards	Recovery
$^{13}\text{C}_{12}\text{-}2,3, 7,8\text{-TCDF}$ $^{13}\text{C}_{12}\text{-}2,3, 7,8\text{-TCDD}$	$^{13}\text{C}_{12}\text{-}1,2,3, 4\text{ TCDD}$ $^{13}\text{C}_{12}\text{-}1,2,3, 4\text{ TCDD}$	
$^{13}\text{C}_{12}\text{-}2,3, 4,7,8\text{-PeCDF}$ $^{13}\text{C}_{12}\text{-}1,2,3, 7,8\text{-PeCDD}$	$^{13}\text{C}_{12}\text{-}1,2,3, 4\text{ TCDD}$ $^{13}\text{C}_{12}\text{-}1,2,3, 4\text{ TCDD}$	
$^{13}\text{C}_{12}\text{-}1,2,3, 4,7,8\text{-HxCDF}$ $^{13}\text{C}_{12}\text{-}1,2,3, 6,7,8\text{-HxCDF}$ $^{13}\text{C}_{12}\text{-}2,3, 4,6,7,8\text{-HxCDF}$ $^{13}\text{C}_{12}\text{-}1,2,3, 4,7,8\text{-HxCDD}$ $^{13}\text{C}_{12}\text{-}1,2,3, 6,7,8\text{-HxCDD}$	$^{13}\text{C}_{12}\text{-}1,2,3, 7,8,9\text{-HxCDD}$ $^{13}\text{C}_{12}\text{-}1,2,3, 7,8,9\text{-HxCDD}$ $^{13}\text{C}_{12}\text{-}1,2,3, 7,8,9\text{-HxCDD}$ $^{13}\text{C}_{12}\text{-}1,2,3, 7,8,9\text{-HxCDD}$ $^{13}\text{C}_{12}\text{-}1,2,3, 7,8,9\text{-HxCDD}$	
$^{13}\text{C}_{12}\text{-}1,2,3,4, 6,7,8\text{-HpCDF}$ $^{13}\text{C}_{12}\text{-}1,2,3,4, 6,7,8\text{-HpCDD}$	$^{13}\text{C}_{12}\text{-}1,2,3, 7,8,9\text{-HxCDD}$ $^{13}\text{C}_{12}\text{-}1,2,3, 7,8,9\text{-HxCDD}$	
$^{13}\text{C}_{12}\text{-OCDF}$ $^{13}\text{C}_{12}\text{-OCDD}$	$^{13}\text{C}_{12}\text{-}1,2,3, 7,8,9\text{-HxCDD}$ $^{13}\text{C}_{12}\text{-}1,2,3, 7,8,9\text{-HxCDD}$	

2.4 Final Calculation

Absolute values (ng) for all the target congeners are calculated considering every volumetric dilution factors. These individual absolute masses are divided by volume of Air collected during sampling to get individual concentrations (ng/Nm³) in flue gas. Finally individual concentrations of all the 17 toxic congeners are multiplied by respective I -TEF (International- Toxic Equivalent Factors) as mentioned in Table – 10 to derive I – TEQ (International- Toxic Equivalent). These individual I-TEQ values are then sum up to get Total I - TEQ value for the sample expressed as ng I-TEQ/NM³

Note: Report the concentration as corrected at 11% O₂

Table - 10: I-TEF (International- Toxic Equivalent Factors) for PCDDs and PCDFs

Target Toxic Congeners	I-TEQ values
2,3, 7,8-TCDD	1.0
1,2,3, 7,8-PeCDD	0.5
1,2,3, 4,7,8 –HxCDD	0.1
1,2,3, 6,7,8 –HxCDD	0.1
1,2,3, 7,8,9 -HxCDD	0.1
1,2,3,4, 6,7,8-HpCDD	0.01
OCDD	0.001
2,3, 7,8-TCDF	0.1
1,2,3, 7,8-PeCDF	0.05
2,3, 4,7,8-PeCDF	0.5
1,2,3, 4,7,8 –HxCDF	0.1
1,2,3, 6,7,8 –HxCDF	0.1
1,2,3, 7,8,9 –HxCDF	0.1
2,3, 4,6,7,8 –HxCDF	0.1
1,2,3,4, 6,7,8-HpCDF	0.01
1,2,3,4, 7,8,9-HpCDF	0.01
OCDF	0.001

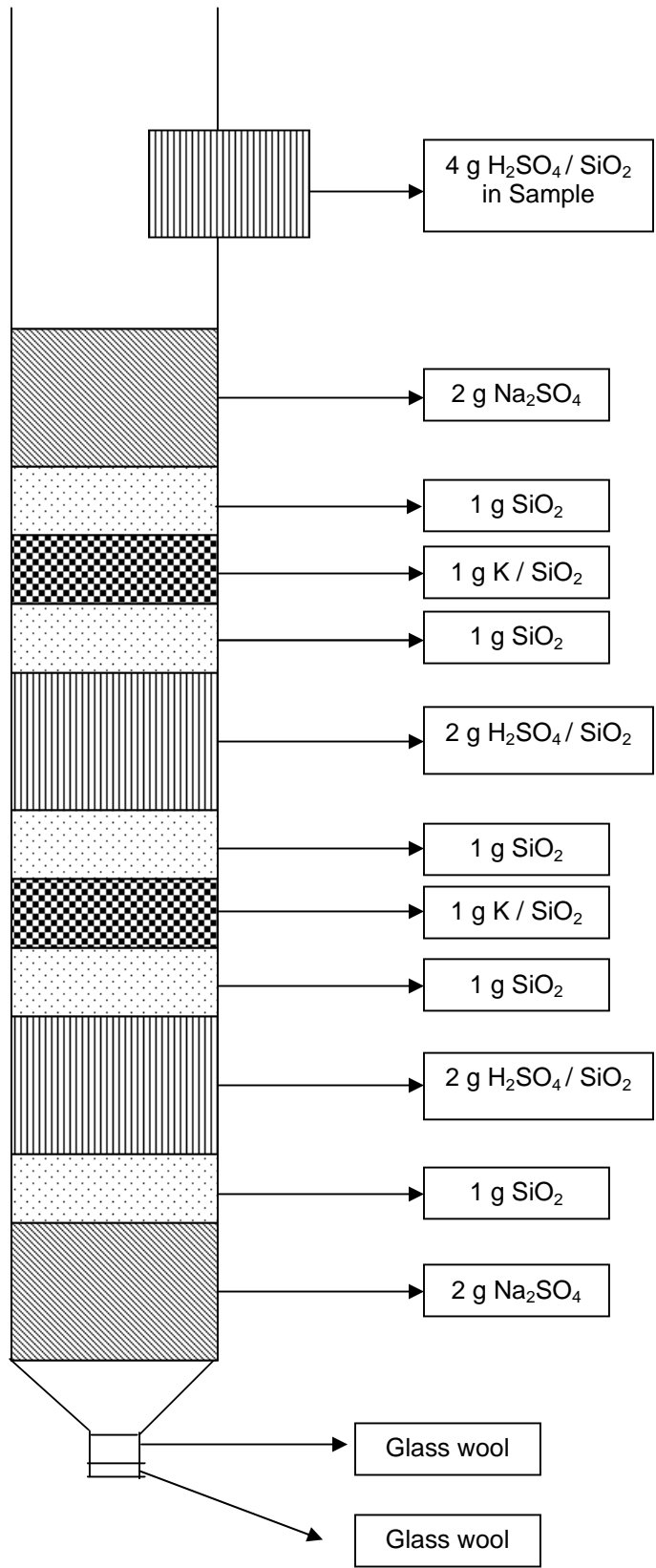

Figure - 3: Multilayer Cleanup Column

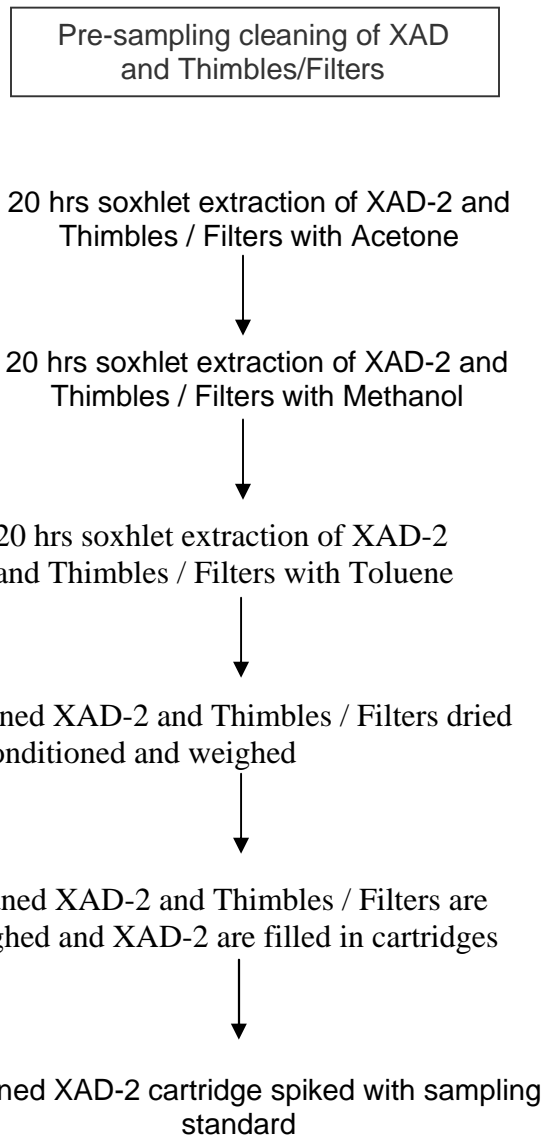

Figure - 4: Pre-Sampling activities

EMISSION SAMPLE EXTRACTION

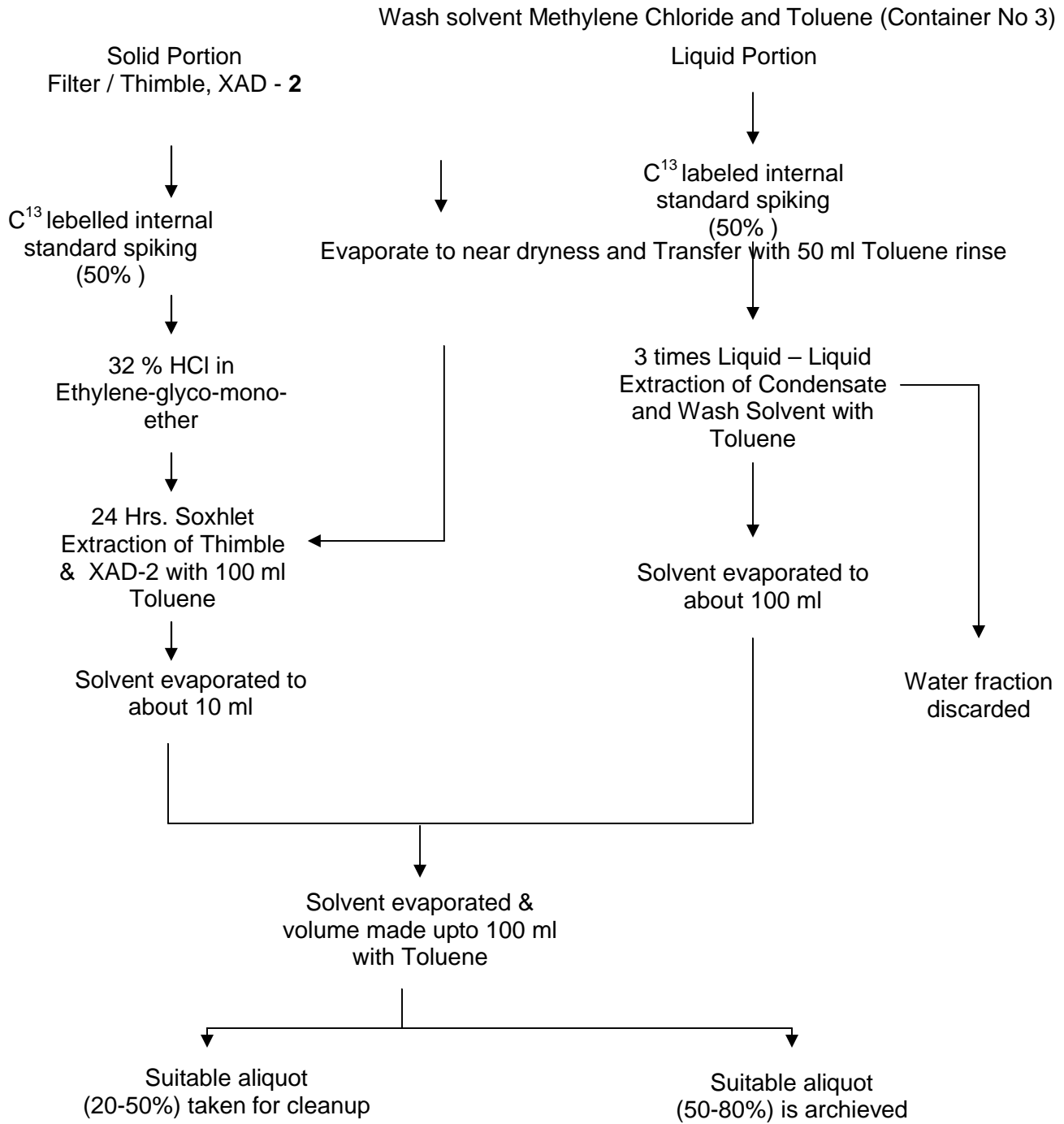

Figure - 5: Schematic Sample Extraction Process

SAMPLE CLEAN UP DIOXINS & FURANS

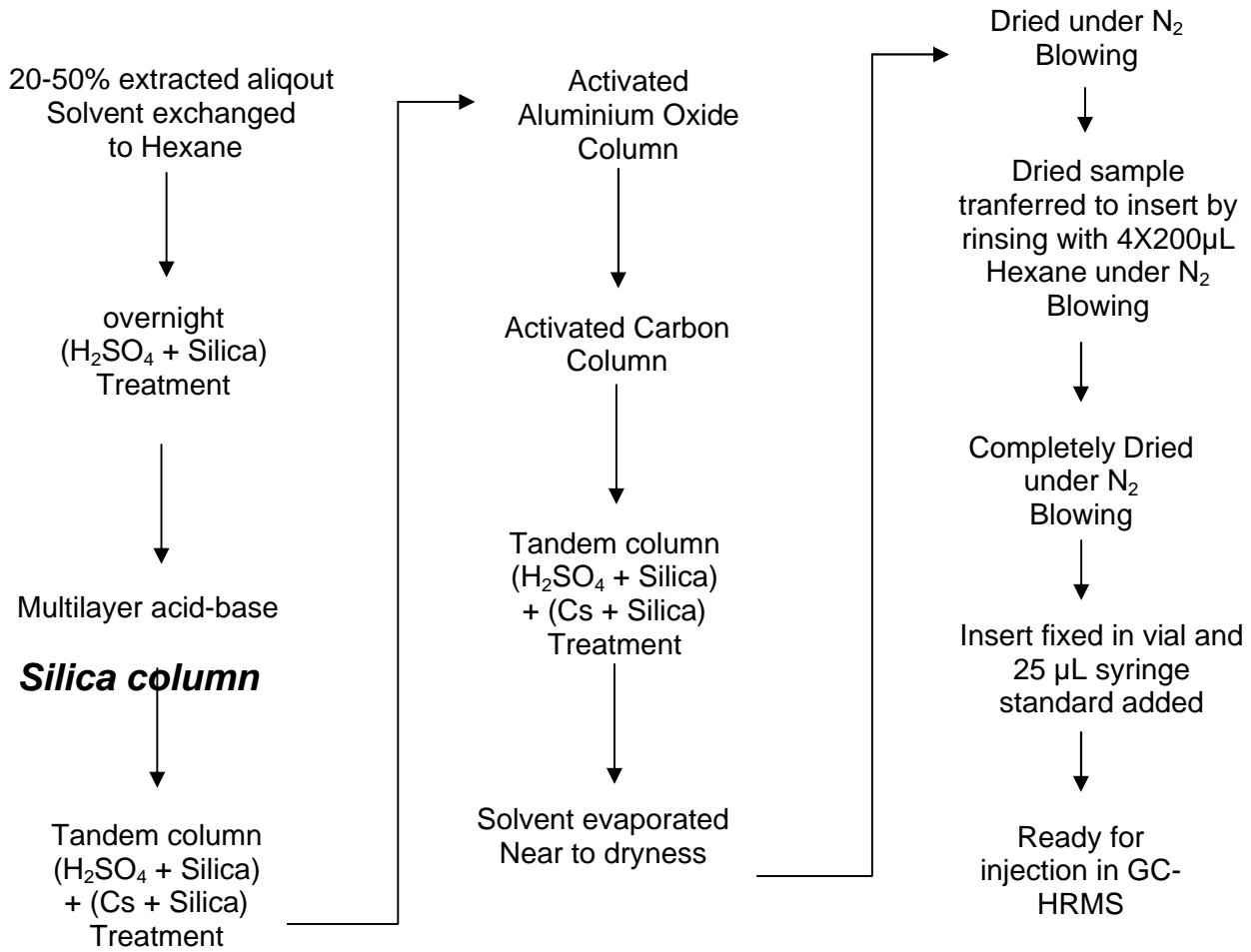

Figure - 6: Schematic Sample Cleanup Process

10. REFERENCES

1. American Society of Mechanical Engineers. Sampling for the Determination of Chlorinated Organic Compounds in Stack Emissions. Prepared for U.S. Department of Energy and U.S. Environmental Protection Agency. Washington DC. December 1984. 25 p.
2. American Society of Mechanical Engineers. Analytical Procedures to Assay Stack Effluent Samples and Residual Combustion Products for Polychlorinated Dibenzo-p-Dioxins (PCDD) and Polychlorinated Dibenzofurans (PCDF). Prepared for the U.S. Department of Energy and U.S. Environmental Protection Agency. Washington, DC. December 1984. 23 p.
3. Thompson, J. R. (ed.). Analysis of Pesticide Residues in Human and Environmental Samples. U.S. Environmental Protection Agency. Research Triangle Park, NC. 1974.
4. Triangle Laboratories. Case Study: Analysis of Samples for the Presence of Tetra Through Octachloro-p-Dibenzodioxins and Dibenzofurans. Research Triangle Park, NC. 1988. 26 p.
5. U.S. Environmental Protection Agency. Method 8290 - The Analysis of Polychlorinated Dibenzo-p-dioxin and Polychlorinated Dibenzofurans by High-Resolution Gas Chromatography/High-Resolution Mass Spectrometry. In: Test Methods for Evaluating Solid Waste. Washington, DC. SW-846.
6. DIN EN 1948
7. VDI 3499, PAR – I

CHAPTER – 8

Standard Operating Procedure for **Sampling** of
Polychlorinated Dibenzo-p-dioxins and Polychlorinated
Dibenzofurans

Standard Operating Procedure for **Analysis** of
Polychlorinated Dibenzo-p-dioxins and Polychlorinated
Dibenzofurans

Disclaimer:

These Standard Operating Procedures (SOPs) are only guidelines for sampling and analysis of metals and non metals in incinerator stack emissions. Concerned Institutes/ Organizations/ laboratories may modify the analytical part according to their need; infrastructure and men power training involved maintaining the QA/QC protocol as required by the method.

Standard Operating Procedure for Sampling of Polychlorinated Dibenzo-p-dioxins and Polychlorinated Dibenzofurans

1.0 PRINCIPLE AND APPLICABILITY

A sample is withdrawn isokinetically from the gas stream and collected in the sample probe, on a glass fiber filter, and on a packed column of adsorbent material. The sample cannot be separated into a particle and vapor fraction. The PCDD's and PCDF's are extracted from the sample, separated by high resolution gas chromatography (HRGC), and measured by high resolution mass spectrometry (HRMS).

2.0 APPLICABILITY

This method is applicable to the determination of emissions of polychlorinated dibenzo-p-dioxins (PCDD's) and polychlorinated dibenzofurans (PCDF's) from stationary sources.

3.0 APPARATUS

3.1 Sampling

A schematic of the sampling train is shown in Figure-1. Sealing greases may not be used in assembling the train.

Table - 1: Apparatus for sampling

S. No	Apparatus	Description
1	Probe	Glass probe or stainless steel probe with glass liner
2	Nozzle	The nozzle shall be made of nickel, nickel-plated stainless steel, quartz, or borosilicate glass.
3	Sample Transfer Lines	The sample transfer lines, if needed, shall be heat traced, heavy walled TFE (½ in. OD with 1/8 in. wall) with connecting fittings that are capable of forming leak free, vacuum-tight connections without using sealing greases. The line shall be as short as possible and must be maintained at 120°C.
4	Condenser	Glass, coil type with compatible fittings. A schematic diagram is shown in Figure – 2
5	Water Bath	Thermostatically controlled to maintain the gas temperature exiting the condenser at 20 - 25°C. Ice water with a recirculation pump may also be used to bring down the temperature at desired level.
6	Adsorbent Module	Glass container to hold the solid adsorbent. A schematic diagram is shown in Figure - 2. Other physical configurations of the resin trap/condenser assembly are also acceptable.

		The connecting fittings shall form leak-free, vacuum tight seals. No sealant greases shall be used in the sampling train. A coarse glass frit on glass wool plug may include retain the adsorbent.
--	--	--

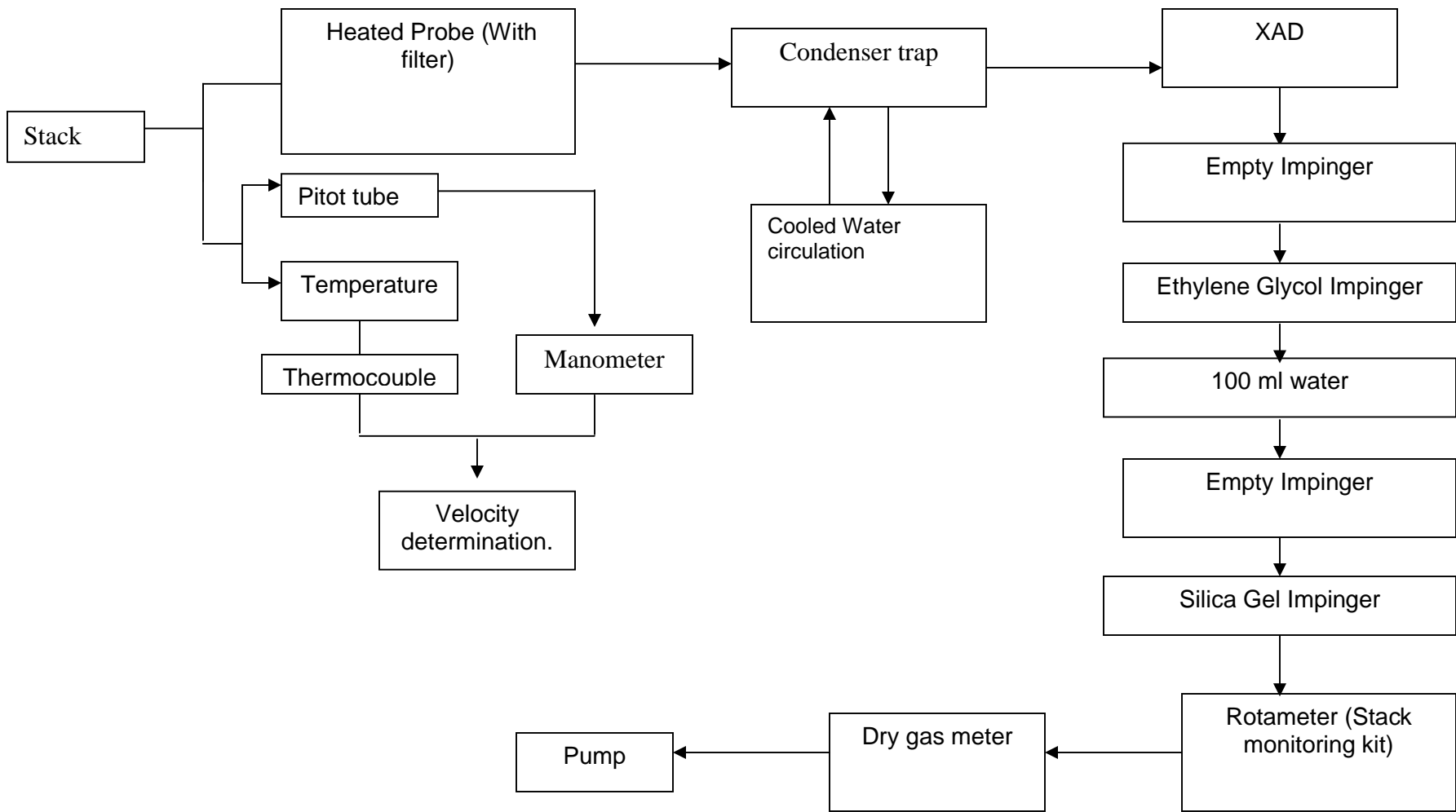

Figure 1: Proposed sampling train of Dioxins and Furans

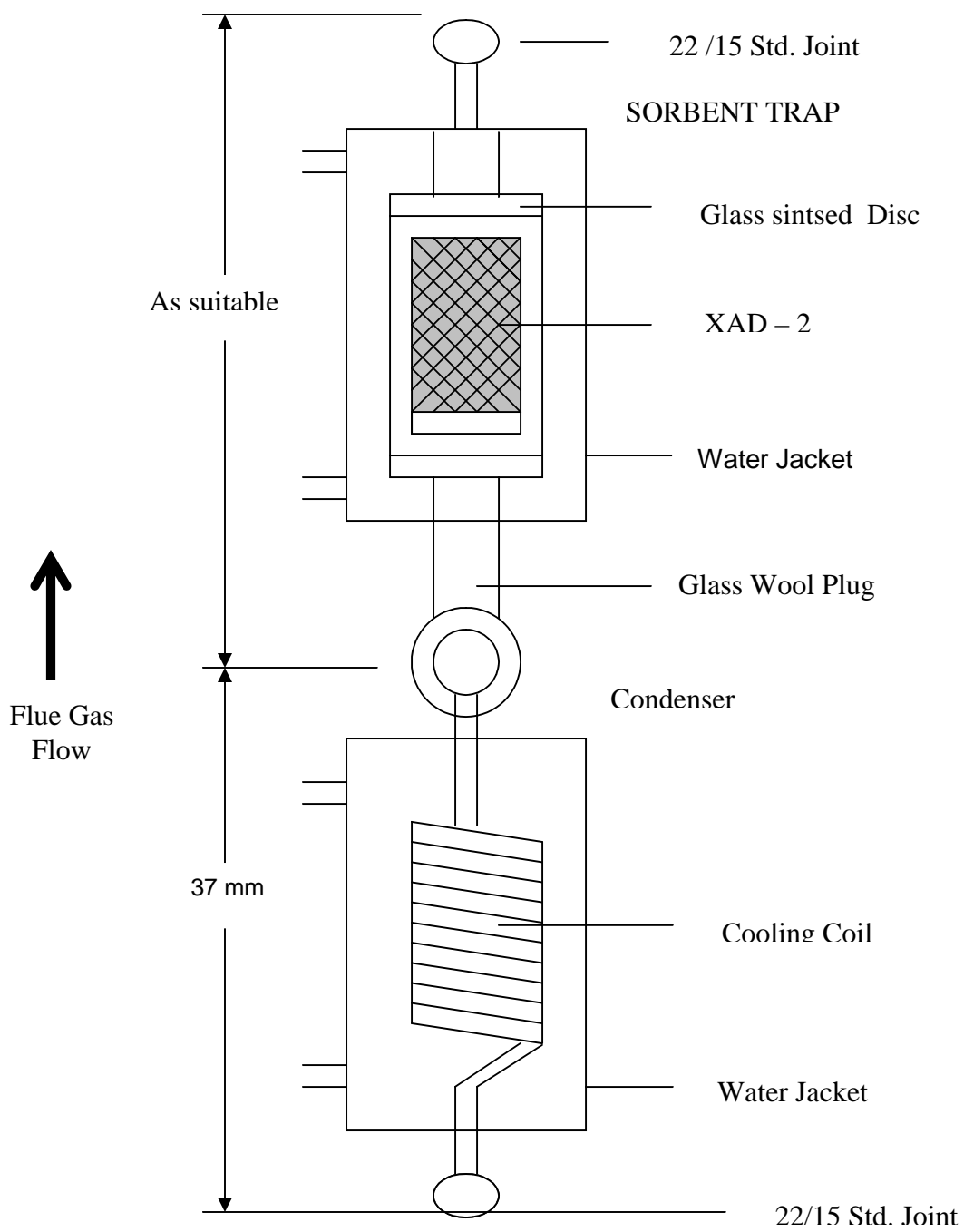

Figure 2: Condenser and Absorbent Trap

3.2 Materials for Pre-sampling laboratory activities

- Soxhlet Extraction Apparatus - Capable of holding 43 x 123 mm extraction thimbles.
- Extraction Thimble - Glass, precleaned cellulosic, or glass fiber.
- Micro pipettes 50 – 100 µl for Std. Spiking
- Reactive-vials - Amber glass, 2-mL, silanized prior to use.
- Rotary Evaporator - Buchi/Brinkman RF-121 or equivalent.
- Nitrogen Evaporative Concentrator - N-Evap Analytical Evaporator Model III or equivalent
- Hot air Oven- At least two (1 upto 250 °C and 1 upto 400 °C)
- Analytical Balance to measure within 0.1 mg.
- Solvents – DCM, Hexane, Toluene, Acetone

4.0 Sampling requirements

4.1 Filters Glass fiber filters (Thimbles), without organic binder

4.2 Adsorbent resin - Amberlite XAD-2 resin.

Note: See method of “Determination of Polychlorinated Dibenzo-p-dioxins and Polychlorinated Dibenzofurans” for the cleaning procedure.

5.0 SAMPLE RECOVERY REAGENT

Solvents and Chemicals

- Acetone - Pesticide quality.
- Methylene Chloride - Pesticide quality.
- Toluene - Pesticide quality.
- Hexane - Pesticide grade.
- Methylene Chloride - Pesticide grade.
- Benzene - Pesticide grade.
- Ethyl Acetate

- Ethylene Glycol
- Methanol - Pesticide grade.
- Toluene - Pesticide grade.
- Nonane - Pesticide grade.
- Cyclohexane - Pesticide Grade.
- Nitrogen - Ultra high purity.
- Hydrogen - Ultra high purity.
- Surrogate (Sampling) Standard Solution

Note: See method of "Determination of Polychlorinated Dibenzo-p-dioxins and Polychlorinated Dibenzofurans" for the preparation of surrogate Standard

6.0 SAMPLING

6.1 Sampling Train components

- Probe assembly – The borosilicate or quartz liner, encased in a stainless steel tube is required to perform stack monitoring. This stainless steel tube is capable of maintaining the exit gas temperature at $120 \pm 14^{\circ}\text{C}$ or at required temperature necessary to prevent condensation during sampling.
- Condenser with condensate trap
- Adsorbent Trap - The trap must be loaded in a clean area to avoid contamination. They may not be loaded in the field. Fill a trap with 20 to 40 g of XAD.
- Silica Gel - Weigh several 200 to 300 g portions of silica gel in air tight containers to the nearest 0.5 g. Record the total weight of the silica gel plus container, on each container. As an alternative, the silica gel may be weighed directly in its impinger or sampling holder just prior to sampling.
- Filter - Check each filter against light for irregularities and flaws or pinhole leaks.
- Pack the filters flat in a clean glass container

6.2 Pre – Sampling Preparation

- Cleaning Glassware - All glass components of the train upstream of and including the adsorbent module shall be cleaned. Special care shall be devoted to the removal of residual silicone grease sealants on ground glass connections of used glassware. Any residue shall be removed by soaking the

glassware for several hours in a chromic acid cleaning solution prior to cleaning as described above

- Loading of Adsorbent Trap - The traps must be loaded in a clean area to avoid contamination. They may not be loaded in the field. Fill a trap with 20 to 40 g of XAD-2. Follow the XAD-2 with glass wool and tightly cap both ends of the trap. Add 100:1 of the surrogate standard solution to each trap.
- Semi-volatile organic compounds associated with particulate matter are collected in the front-half components of the sampling train.
- Semi-volatile organic compounds not collected by high efficiency glass or quartz fiber are adsorbed on porous, polymeric resin, Amberlite XAD-2.
- The borosilicate or quartz liner, encased in a stainless steel tube is required to perform stack monitoring. This stainless steel tube is capable of maintaining the exit gas temperature at $120 \pm 14^{\circ}\text{C}$ or at required temperature necessary to prevent condensation during sampling.
- In order to obtain reliable results, testers and analysts should be trained and experienced with the procedures.

6.3 Preliminary Determinations

Determine the stack pressure, temperature, leak check and isokinetic velocity, volumetric flow rate, flow at nozzle and also calculate sampling rate at the gas meter, volume of gas sampled during sampling as described in the SOP of the particulate matter.

6.4 Preparation of Collection Train

During preparation and assembly of the sampling train, keep all train openings where contamination can enter, sealed until sampling is about to begin.

- Place approximately 100 mL of ethylene glycol and 100 ml water in the second and third impingers respectively, leave the first and fourth impingers empty, and transfer approximately 200 to 300 g of preweighed silica gel from its container to the fifth impinger.
- Place the silica gel container in a clean place for later use in the sample recovery. Alternatively, the weight of the silica gel plus the fifth impinger may be determined to the nearest 0.5 g and recorded.

Assemble the sampling train as shown in Figure - 1

- Turn on the adsorbent module and condenser coil recirculation pump and begin monitoring the adsorbent module gas entry temperature.
- Ensure proper sorbent gas entry temperature before proceeding and before sampling is initiated. It is extremely important that the XAD-2 adsorbent resin temperature never exceed 50°C because thermal decomposition will occur.

(During testing, the XAD-2 temperature must not exceed 20°C for efficient capture of the PCDD's and PCDF's).

7.0 Sample Recovery

- Remove probe from the stack. Seal the nozzle end of the sampling probe with Teflon tape or aluminum foil.
- When the probe can be safely handled, wipe off all external particulate matter near the tip of the probe. Remove the probe from the train and close off both ends with aluminum foil. Seal off the inlet to the train with Teflon tape, a ground glass cap, or aluminum foil.
- Transfer the probe and impinger assembly to the cleanup area. Make sure that any contamination should not take place during handling of sample.
- Inspect the train prior to and during disassembly and note any abnormal or abnormal conditions, e.g., broken filters, colored impinger liquid, etc. treat the samples as follows:
 - Container No. 1 - Either seal the filter holder or carefully remove the filter from the filter holder and place it in its identified container. Do not place the filter in aluminum foil. Use a pair of cleaned tweezers to handle the filter. If it is necessary to fold the filter, do so such that the particulate cake is inside the fold. Carefully transfer to the container any particulate matter and filter fibers which adhere to the filter holder gasket, by using a dry inert bristle brush and a sharp-edged blade. Seal the container.
 - Adsorbent Module - Remove the module from the train, tightly cap both ends, label it, and store it on ice for transport to the laboratory.
 - Container No. 2 - Quantitatively recover material deposited in the nozzle, probe transfer lines, the front half of the filter holder, and the cyclone, if used, first, by brushing while rinsing three times with acetone and then, by rinsing the probe three times with methylene chloride. Collect all the rinses in Container No. 2. Rinse the back half of the filter holder three times with acetone. Rinse the connecting line between the filter and the condenser three times with acetone. Soak the connecting line with three separate portions of methylene chloride for 5 minutes each. If using a separate condenser and adsorbent trap, rinse the condenser in the same manner as the connecting line. Collect all the rinses in Container No. 2 and mark the level of the liquid on the container.
 - Container No. 3 - Repeat the methylene chloride-rinsing followed by toluene rinse. Collect the rinses in Container No. 3 and mark the level of the liquid on the container.

- Container No. 4 – Liquid of Ethylene glycol trap is collected in 4th container with methylene chloride wash
- Impinger Water - Measure the liquid in the first four impingers to within 1 mL by using a graduated cylinder or by weighing it to within 0.5 g by using a balance. Record the volume or weight of liquid present. This information is required to calculate the moisture content of the effluent gas. Discard only the water fraction after measuring and recording the volume or weight.
- Silica Gel - Note the color of the indicating silica gel to determine if it has been completely spent and make a mention of its condition. Transfer the silica gel from the fifth impinger to its original container and seal.

8.0 CALCULATIONS

For Molecular weight determination, Stack gas velocity, Isokinetic Flow rate, Moisture content and parameters required for particulate emission calculation follow the formulae mentioned in method prescribed Particulate matter determination.

Dry Gas Volume. Using the data from this test, calculate V , the dry gas sample volume at standard conditions $m(\text{std})$ as outline Correct the sample volume measured by the dry gas meter to standard conditions (25°C, 760 mm Hg or 68°F, 29.92in. Hg) by using following Equation. Where, Y is DGM Calibration Factor.

$$V_{m(\text{std})} = V_m Y \left[\frac{T_{\text{std}}}{T_m} \right] \left[\frac{P_{\text{bar}}}{P_{\text{std}}} \right] = K_1 Y V_m \left[\frac{P_{\text{bar}}}{T_m} \right]$$

Where:

$K_1 = 0.3858 \text{ } ^\circ\text{K}/\text{mm Hg}$ for metric units,
 $= 17.64 \text{ } ^\circ\text{C}/\text{in. Hg}$ for English units

P_{bar} = Barometric pressure at the exit orifice of the DGM, mm Hg (in. Hg).

P_{std} = Standard absolute pressure, 760 mm Hg (29.92 in. Hg).

T_m = Average DGM absolute temperature, °K (°c).

T_{std} = Standard absolute temperature, 293°K

Y = Dry gas meter calibration factor

$V_{m(\text{std})}$ = Dry gas volume measured by the dry gas meter, corrected to standard conditions, Nm^3

V_m = {Sampling rate in gas channel (LPM) X duration (Minutes)} / 1000 m^3 .

9.0 REFERENCES

1. American Society of Mechanical Engineers. Sampling for the Determination of Chlorinated Organic Compounds in Stack Emissions. Prepared for U.S. Department of Energy and U.S. Environmental Protection Agency. Washington DC. December 1984. 25 p.
2. American Society of Mechanical Engineers. Analytical Procedures to Assay Stack Effluent Samples and Residual Combustion Products for Polychlorinated Dibenzo-p-Dioxins (PCDD) and Polychlorinated Dibenzofurans (PCDF). Prepared for the U.S. Department of Energy and U.S. Environmental Protection Agency. Washington, DC. December 1984. 23 p.
3. Thompson, J. R. (ed.). Analysis of Pesticide Residues in Human and Environmental Samples. U.S. Environmental Protection Agency. Research Triangle Park, NC. 1974.
4. Triangle Laboratories. Case Study: Analysis of Samples for the Presence of Tetra Through Octachloro-p-Dibenzodioxins and Dibenzofurans. Research Triangle Park, NC. 1988. 26 p.
5. U.S. Environmental Protection Agency. Method 8290 - The Analysis of Polychlorinated Dibenzo-p-dioxin and Polychlorinated Dibenzofurans by High-Resolution Gas Chromatography/High-Resolution Mass Spectrometry. In: Test Methods for Evaluating Solid Waste. Washington, DC. SW-846.
6. DIN EN 1948
7. VDI 3499, PAR – I

Standard Operating Procedure for analysis of Polychlorinated Dibenzo-p-dioxins and Polychlorinated Dibenzofurans

1.0 ANALYSIS

Total number of isomers in PCDDs and PCDFs family is 210. Among which 17 congeners are toxic having TEF (Toxic Equivalent Factors) values. It is not always possible for a Low Resolution Mass Spectrometer to distinguish slight variation in mass of two ions generated from different isomers. For this reason High Resolution Mass Spectrometry with 10000 resolutions is used for PCDDs and PCDFs analysis by which a change in mass at 4th decimal place can also be easily separated and identified. Ultra trace level analysis of dioxin and furans is based on isotopic dilution technique. It has unique quality control protocol and final results are always compensated for any loss during pre-treatment of sample.

1.1 Glassware Cleaning

All glassware shall be cleaned as required for any ultra trace organic analysis. Samples must be extracted within 30 days of collection and analyzed within 45 days of extraction.

1.2 Sample Extraction

Extraction System - Place an extraction thimble 1 g of silica gel, and a plug of glass wool into the Soxhlet apparatus, charge the apparatus with toluene, and reflux for a minimum of 3 hours. Remove the toluene and discard it, but retain the silica gel. Remove the extraction thimble from the extraction system and place it in a glass beaker to catch the solvent rinses.

Sample extraction:

1.2.1 XAD-2 Resin

- a) Outside XAD cartridge is wiped with Solvent Soaked paper
- b) About 500 ml solvent mixture (Toluene: Acetone 80 %+ 20%) is taken in a 1000 ml RB Boiling flask.
- c) Teflon boiling chips are added in the flask.
- d) Two small glass tubes are placed at the bottom of Soxhlet separator.
- e) Insert the XAD upright.
- f) Spiked with 50 μ L Internal Standard (Extraction Standard) on XAD-2 (Table – 1)
- g) XAD tube is plugged with glass stopper inside Soxhlet to prevent spill over.
- h) Flask and soxhlet are placed on heating mantle
- i) Connect the same with condenser
- j) Perform extraction for at least 20 hrs.
- k) Parallel Blank was taken without XAD tubes but with thimbles.

1.2.2 Filter / Thimble

- a) After completion of XAD extraction the filter part of the sample is taken. The glass cartridge is wiped with solvent soaked paper from outside if particulates are collected on glass wool.
- b) XAD Tubes are unloaded and archived until analysis is complete.
- c) Filter tubes are placed in same Soxhlet tube (in case of glass wool filter). Otherwise place the thimble in soxhlet tube.
- d) Add 10 ml HCL in 2% Ethylene-glyco-monoether to dissolve the inorganic part. Volume may vary depending on particulate load in sample.
- e) Spiked with 50 μ L Internal Standard (Extraction Standard).
- d) Plugged with glass stopper at the top to prevent spill over.
- e) Attached to the same solvent flask of previous day extract (XAD-2)
- F) Attached to condenser and extracted for 24 hrs.
- g) After extraction the sample (wool/ filter) was squeezed by forceps rinsed with Acetone (4 to five times) finally squeezed and removed. The tube is marked and archived.
- h) Flask is detached from soxhlet.

1.2.3 Liquid Condensate and rinses

- a) The liquid part of emission samples (Condensate and train rinsing samples) are extracted with solvent (liquid- liquid extraction)
- b) The samples are transferred to a separating funnel.
- c) First rinse was provided by sample rinse (Collected infield)
- d) Second rinse of each bottle with Acetone (100 ml)
- e) Third rinse of each bottle with Toluene (100 ml).
- f) Same volume of water including Acetone rinse volume is taken for blank extraction.
- g) The whole Solvent from the combined XAD / Filter/ wool is transferred to separator funnel.
- h) Shaken rigorously. Allowed to settle.
- i) Repeated the extraction for 3 times with Acetone + Toluene (20% + 80%)
- j) The whole solvent is taken and concentrated to about 50 ml. Transferred to 100 ml volumetric flask. Made up the volume with Toluene.
- k) 20 - 50 ml is taken for clean up. Rest 50 - 80 ml is archived for crosschecking if found necessary.
- l) This sample will join the pool (QC Sample) sample in next phase of processing i.e., Sample Clean up)

1.3 Sample Clean up

STEP – 1

- a) 20 ml or suitable aliquot is taken in 50 ml conical rotary flask.
- b) Blank and Pool (Control) should run in parallel.
- c) 4 g H_2SO_4 / SiO_2 was added allowed to react for hours. Better to leave overnight.
- d) Prepared Multilayer clean up column as shown in Figure- 1. Air gaps, if any, should be removed by N_2 blowing with Hexane.
- f) 100 ml conical Rotary flask taken placed below the column.
- h) Sample (SiO_2 / H_2SO_4 treated) are loaded to the column by pasture pipette. The solid parts are transferred first and then Solvent.
- i) 4 x 3 ml Hexane rinses provided.
- j) Final rinse with 30 ml Hexane.
- k) The collected Solvent is concentrated to 4 -5 ml.
- l) Samples are ready for Tandem/ ALOX clean up in next stage.

Step II

- A) Tandem Column Preparation
 - a) 250 mm Pasteur pipettes taken
 - b) plugged with glass wool (glass cotton)
 - c) 0.7 gm SiO_2 / H_2SO_4 was loaded.
 - d) 0.3 gm SiO_2 / Cs was loaded on top
- B) Alex Column Preparation
 - a) prepared Alex (Aluminum Oxide) column
 - b) 3.65- 3.70 gm Alumina oxide (hot) is loaded in plugged column.
 - c) Little (1.0 gm) Na_2SO_4 added on top
 - d) Both the column washed with Hexane under N_2 purging to remove air gaps

- e) Tandem was placed at top of the Alex column.
- f) Sample loaded directly on the top of tandem column.
- g) 4 times rinse with 2ml Hexane in each time.
- h) Tandem column is removed
- i) 7 ml Hexane at the top of Alex column.
- j) 6 ml Hexane: DCM (98: 2) added on top of alumina column.
- k) The whole waste discarded and sample collection flask is placed 50 ml conical rotary flask.
- l) The PCDDs/DFs eluted with 25 ml Hexane.: DCM (1:1)
- m) The elute is evaporated to dryness.
- n) The sample is ready for Carbo pack column clean up.

STEP III

- a) 0.5 gm carbopack (Supeleo) was loaded in Carbo pack Column (10mm dia).
- b) Rinsed with Toluene under N₂ Purging.
- c) Washed with mixed Solvent - A (Di chloromethane :Methanol : Toluene : : 75 : 20 : 5)
- d) Washed with Solvent A was added to the Sample flask, Mixed well and Sample Loaded to the column.
- e) 3 × 2 ml washing with Solvent A.
- f) 1 ml Solvent - A is charged directly on top of the column.
- g) Loaded 0.5 ml DCM : Methanol : Toluene :: 75 :20: 5.
- h) Waste Discarded.
- i) PCDDs /Fs eluted with 60 ml Toluene, Collected in new wasted Rotary flask (100ml). The volume of, Toluene may vary according to the batch of Carbopack.
- j) The eluted Solvent evaporated to dryness.
- k) New Tandem Column Prepared (0.7 gm SiO₂/ H₂SO₄ + .39 m Cs/ SiO₂)
- l) Washed with Hexane under N₂ purging.
- m) 2 ml Hexane added in the dried sample flask.
- n) Sample loaded to the tandem column.
- o) 4 × 2 ml Hexane rinse provided. Elute collected in 25 ml conical rotary flask.
- p) Flask dried under N₂ purging

STEP IV

- a) Vial insert are placed under N₂ Purging system
- b) 200 ml Haxane added to the dried flask.
- c) Sample transferred to insert by micro pipette tips (glass 100 ml)
- d) 3 rinses with 200 ul each provided (Hexane)
- e) Allowed to dry under N₂ Purging.
- f) 25 µL of Recovery (syringe / Injection / performance) Standard (Table-2) is added to the insert.
- g) Crimped the vials (marked)
- h) Ready for HRGC – HRMS Analysis.

Table 1: Internal (Extraction) Standards

Labelled Isomers	Minimum Spiking volume	Maximum mass in picograms
¹³ C ₁₂ -2,3, 7,8-TCDF		400

¹³ C ₁₂ -2,3, 7,8-TCDD	50 µL (on XAD) + 50 µL (on Filter) = 100 µL	400
¹³ C ₁₂ -2,3, 4,7,8-PeCDF		400
¹³ C ₁₂ -1,2,3, 7,8-PeCDD		400
¹³ C ₁₂ -1,2,3, 4,7,8 -HxCDF		400
¹³ C ₁₂ -1,2,3, 6,7,8 -HxCDF		400
¹³ C ₁₂ -2,3, 4,6,7,8 -HxCDF		400
¹³ C ₁₂ -1,2,3, 4,7,8 -HxCDD		400
¹³ C ₁₂ -1,2,3, 6,7,8 -HxCDD		400
¹³ C ₁₂ -1,2,3,4, 6,7,8-HpCDF		800
¹³ C ₁₂ -1,2,3,4, 6,7,8-HpCDD		800
¹³ C ₁₂ -OCDF	800	
¹³ C ₁₂ -OCDD	800	

Table 2: Recovery (Syringe / Injection / Performance) Standards

Labelled Isomers	Spiking volume	Maximum mass in picograms
¹³ C ₁₂ -1,2,3, 4 TCDD	25 µL	400
¹³ C ₁₂ -1,2,3, 7,8,9 -HxCDD		400

2.0 Analysis

Analyze the sample with a High Resolution Gas chromatograph coupled to a High Resolution Mass Spectrometer (HRGC-HRMS). 1-3 µL sample extracts are first analyzed using the DB-5 capillary column to determine the concentration of each isomer of PCDD's and PCDF's (tetra-through octa-). If tetrachlorinated dibenzofurans are detected in this analysis, then analyze another aliquot of the sample in a separate run, using the DB-225 column to measure the 2,3,7,8 tetra-chloro dibenzofuran isomer. Other column systems may be used, provided that the user is able to demonstrate using calibration and performance checks that the column system is able to meet the specifications.

(A) General Gas Chromatograph Operating Conditions.

- Injector - Configured for capillary column, splitless, 250 °C.
- Carrier Gas - Helium, 1-2 ml/min.
- Oven - Initially at 150 °C. Rise by at least 40 °C/min to 190 °C and then by a suitable ramp (X °C/min) up to 300 °C.

(B) High Resolution Mass Spectrometer.

- Resolution - 10,000 m/e.
- Ionization Mode - Electron impact.
- Source Temperature - 270°C (for Polar column)
- 280 °C (for non polar column)

Monitoring Mode - Selected ion monitoring. A list of the various ions to be monitored is presented in Table 3a (non polar column) and b (for polar column).

Table 3a: Masses of ions monitored for determination using non-polar column

Group 1	Group 2	Group 3
---------	---------	---------

Ions	Mass in ME	Ions	Mass in ME	Ions	Mass in ME
TCDF	303.9016	PeCDF	339.8598	HxCDF	373.8208
TCDF	305.8988	PeCDF	341.8569	HxCDF	375.8179
TCDF- ¹³ C ₁₂	315.9419	PeCDF- ¹³ C ₁₂	351.9000	Lock Mass check	380.9760
Lock Mass check	316.9824	PeCDF- ¹³ C ₁₂	353.8970	Lock Mass	380.9760
Lock Mass	316.9824	PeCDD	355.8547	HxCDF- ¹³ C ₁₂	385.8610
TCDF - ¹³ C ₁₂	317.9389	PeCDD	357.8518	HxCDF- ¹³ C ₁₂	387.8581
TCDD	319.8965	Lock Mass check	366.9792	HxCDD	389.8157
TCDD	321.8937	Lock Mass	366.9792	HxCDD	391.8128
TCDD - ¹³ C ₁₂	331.9368	PeCDD- ¹³ C ₁₂	367.8949	HxCDD- ¹³ C ₁₂	401.8559
TCDD - ¹³ C ₁₂	333.9339	PeCDF- ¹³ C ₁₂	369.8920	HxCDF- ¹³ C ₁₂	403.8530

...Continued Table 3 a

Group 4		Group 5	
Ions	Mass in ME	Ions	Mass in ME
HpCDF	407.7818	OCDF	441.7428
HpCDF	409.7789	OCDF	443.7399
HpCDF- ¹³ C ₁₂	419.8220	OCDF - ¹³ C ₁₂	453.7831
HpCDF- ¹³ C ₁₂	421.8191	Lock Mass check	454.9728
HpCDD	423.7767	Lock Mass	454.9728
HpCDD	524.7739	OCDF - ¹³ C ₁₂	455.7801
Lock Mass check	430.9728	OCDD	457.7377
Lock Mass	430.9728	OCDD	459.7349
HpCDD- ¹³ C ₁₂	435.8169	OCDD - ¹³ C ₁₂	469.7780
HpCDD- ¹³ C ₁₂	437.8140	OCDD - ¹³ C ₁₂	471.7750

Table 3b: Masses of ions monitored for determination using polar column

Group 1		Group 2	
Ions	Mass in ME	Ions	Mass in ME
TCDF	303.9016	HxCDF	373.8208
TCDF	305.8988	HxCDF	375.8179
TCDF- ¹³ C ₁₂	315.9419	HxCDF- ¹³ C ₁₂	385.8610
TCDF - ¹³ C ₁₂	317.9389	HxCDF- ¹³ C ₁₂	387.8581
TCDD	319.8965	HpCDF	407.7818
TCDD	321.8937	HpCDF	409.7789
TCDD - ¹³ C ₁₂	331.9368	HpCDF- ¹³ C ₁₂	419.8220
TCDD - ¹³ C ₁₂	333.9339	HpCDF- ¹³ C ₁₂	421.8191
PeCDF	339.8598	HpCDD	423.7767
PeCDF	341.8569	HpCDD	425.7739
PeCDF- ¹³ C ₁₂	351.9000	Lock Mass check	430.9728
PeCDF- ¹³ C ₁₂	353.8970	Lock Mass	430.9728
PeCDD	355.8547	HpCDD- ¹³ C ₁₂	435.8169
PeCDD	357.8518	HpCDD- ¹³ C ₁₂	437.8140
Lock Mass check	366.9792		
Lock Mass	366.9792	OCDF	441.7428

PeCDD- ¹³ C ₁₂	367.8949	OCDF	443.7399
PeCDD- ¹³ C ₁₂	369.8920	OCDF – ¹³ C ₁₂	453.7831
HxCDF	373.8208	OCDF – ¹³ C ₁₂	455.7801
HxCDF	375.8179	OCDD	457.7377
HxCDF- ¹³ C ₁₂	385.8610	OCDD	459.7349
HxCDF- ¹³ C ₁₂	387.8581	OCDD – ¹³ C ₁₂	469.7780
HxCDD	389.8157	OCDD – ¹³ C ₁₂	471.7750
HxCDD	391.8128		
HxCDD- ¹³ C ₁₂	401.8559		
HxCDF- ¹³ C ₁₂	403.8530		

Identification Criteria –The following identification criteria shall be used for the characterization of polychlorinated dibenzodioxins and dibenzofurans. The mass fragmentograms furnish both qualitative and quantitative information. A congener is characterized by mole mass, isotope ratio and retention time. The qualitative alignment of the measurement signals (peaks) is carried out by comparing retention times of those of internal reference substances and with the correct isotope ratio at a given mole mass M⁺, (M + 2)⁺ and (M + 4)⁺. The peak areas are in proportion to the injected mass of the substances.

1. The integrated ion-abundance ratio (M/M+2 or M+2/M+4) shall be within 15 percent of the theoretical value. The acceptable ion-abundance ratio should ranges (+15%) for the identification of chlorine-containing compounds.
2. The retention time for the analytes must be within 3 seconds of the corresponding ¹³C labeled internal standard or surrogate standard.
3. The monitored ions, for a given analyte, shall reach their maximum within 2 seconds of each other.
4. The identification of specific isomers that do not have corresponding ¹³C-labeled standards is done by comparison of the relative retention time (RRT) of the analyte to the nearest internal standard retention time with reference (i.e., within 0.005 RRT units) to the comparable RRT's found in the continuing calibration.
5. The signal to noise ratio for all monitored ions must be greater than 2.5.
6. The confirmation of 2, 3, 7, 8-TCDF shall satisfy all of the above identification criteria.

2.1 Quantification – The quantitative determination is performed according to the isotope dilution method. A known mass of extraction standard is added to the sample prior to the sample preparation. In the mass fragmentogram the areas of signals from the ¹³C₁₂ labelled internal standard are correlated with corresponding substances to be determined.

$$m_{i\ 12C} = \frac{m_{i\ 13C} * F_{i\ 12C}}{RRF_i * F_{i\ 13C}}$$

Where:

$m_{i\ 12C}$ – mass of native congener i

$m_{i\ 13C}$ – mass of corresponding ¹³C₁₂ labelled standard (congener) i added to the sample

$F_{i\ 12C}$ – Area of the peak of the native congener i (1 ion or sum of better two ions)

$F_{i\ 13C}$ – Area of the peak of the corresponding ¹³C₁₂ labelled standard (congener) i added to the sample

RRF_i – Relative Response Factor of the native congener I relative to the corresponding ¹³C₁₂ labelled congener i.

For some native congeners corresponding ¹³C₁₂ labelled congeners are used as sampling or recovery standards and so can not be used for calculation of RRF. In these cases a congener with similar properties are used. The quantification scheme for PCDDs/PCDFs in emission samples is presented in Table – 4

Table 4: Quantitation Scheme for PCDDs and PCDFs

Target Analyte having TEF	Corresponding Extraction (Internal) Standards
2,3, 7,8-TCDD	¹³ C ₁₂ -2,3, 7,8-TCDD
1,2,3, 7,8-PeCDD	¹³ C ₁₂ -1,2,3, 7,8-PeCDD
1,2,3, 4,7,8 –HxCDD	¹³ C ₁₂ -1,2,3, 4,7,8 -HxCDD
1,2,3, 6,7,8 –HxCDD	¹³ C ₁₂ -1,2,3, 6,7,8 -HxCDD
1,2,3, 7,8,9 -HxCDD	¹³ C ₁₂ -1,2,3, 6,7,8 -HxCDD
1,2,3,4, 6,7,8-HpCDD	¹³ C ₁₂ -1,2,3,4, 6,7,8-HpCDD
OCDD	¹³ C ₁₂ -OCDD
2,3, 7,8-TCDF	¹³ C ₁₂ -2,3, 7,8-TCDF
1,2,3, 7,8-PeCDF	¹³ C ₁₂ -2,3, 4,7,8-PeCDF
2,3, 4,7,8-PeCDF	¹³ C ₁₂ -2,3, 4,7,8-PeCDF
1,2,3, 4,7,8 –HxCDF	¹³ C ₁₂ -1,2,3, 4,7,8 -HxCDF
1,2,3, 6,7,8 –HxCDF	¹³ C ₁₂ -1,2,3, 6,7,8 –HxCDF
1,2,3, 7,8,9 –HxCDF	¹³ C ₁₂ -2,3, 4,6,7,8 –HxCDF
2,3, 4,6,7,8 –HxCDF	¹³ C ₁₂ -2,3, 4,6,7,8 –HxCDF
1,2,3,4, 6,7,8-HpCDF	¹³ C ₁₂ -1,2,3,4, 6,7,8-HpCDF
1,2,3,4, 7,8,9-HpCDF	¹³ C ₁₂ -1,2,3,4, 6,7,8-HpCDF
OCDF	¹³ C ₁₂ -OCDF

2.2 CALIBRATION

The instrument calibration standards shall contain all congeners of native standards (target analytes), Internal (Extraction) Standards, Surrogate (Sampling / Recovery standards) and Recovery (Syringe / Performance / Injection Standard)

2.2.1 Initial Calibration

Calibrate the GC/MS system using the set of five standards shown in Table 5 The signal to noise ratio for the GC signal present in every selected ion current profile shall be greater than or equal to 2.5. The ion abundance ratios shall be within the control limits.

Table 5: Mixed Calibration standard

Calibration mixture I	¹² C congener's concentration ng/μL	¹³ C congener's concentration ng/μL (in Sampling, Internal, Syringe Standard)
1,2,3,4 – TCDD (Recovery/Syringe Standard)	----	10
2,3, 7,8-TCDD	0.5	10
1,2,3, 7,8-PeCDD	0.5	10
1,2,3, 4,7,8 –HxCDD	0.5	10
1,2,3, 6,7,8 –HxCDD	0.5	10
1,2,3, 7,8,9 -HxCDD	0.5	10
1,2,3,4, 6,7,8-HpCDD	1.0	20
OCDD	1.0	20
2,3, 7,8-TCDF	0.5	10
1,2,3, 7,8-PeCDF	0.5	10
2,3, 4,7,8-PeCDF	0.5	10
1,2,3, 4,7,8 –HxCDF	0.5	10
1,2,3, 6,7,8 –HxCDF	0.5	10
1,2,3, 7,8,9 –HxCDF	0.5	10
2,3, 4,6,7,8 –HxCDF	0.5	10
1,2,3,4, 6,7,8-HpCDF	1.0	20
1,2,3,4, 7,8,9-HpCDF	1.0	20
OCDF	1.0	20
Calibration mixture II	¹² C congener's concentration ng/μL	¹³ C congener's concentration ng/μL (in Sampling, Internal, Syringe Standard)
1,2,3,4 – TCDD (Recovery/Syringe Standard)	----	10
2,3, 7,8-TCDD	2.0	10
1,2,3, 7,8-PeCDD	2.0	10
1,2,3, 4,7,8 –HxCDD	2.0	10
1,2,3, 6,7,8 –HxCDD	2.0	10
1,2,3, 7,8,9 -HxCDD	2.0	10
1,2,3,4, 6,7,8-HpCDD	4.0	20
OCDD	4.0	20
2,3, 7,8-TCDF	2.0	10
1,2,3, 7,8-PeCDF	2.0	10
2,3, 4,7,8-PeCDF	2.0	10
1,2,3, 4,7,8 –HxCDF	2.0	10
1,2,3, 6,7,8 –HxCDF	2.0	10
1,2,3, 7,8,9 –HxCDF	2.0	10
2,3, 4,6,7,8 –HxCDF	2.0	10
1,2,3,4, 6,7,8-HpCDF	4.0	20
1,2,3,4, 7,8,9-HpCDF	4.0	20
OCDF	4.0	20
Calibration mixture III	¹² C congener's concentration ng/μL	¹³ C congener's concentration ng/μL (in Sampling, Internal, Syringe Standard)
1,2,3,4 – TCDD (Recovery/Syringe Standard)	----	10
2,3, 7,8-TCDD	10.0	10
1,2,3, 7,8-PeCDD	10.0	10

1,2,3, 4,7,8 –HxCDD	10.0	10
1,2,3, 6,7,8 –HxCDD	10.0	10
1,2,3, 7,8,9 -HxCDD	10.0	10
1,2,3,4, 6,7,8-HpCDD	20.0	20
OCDD	20.0	20
2,3, 7,8-TCDF	10.0	10
1,2,3, 7,8-PeCDF	10.0	10
2,3, 4,7,8-PeCDF	10.0	10
1,2,3, 4,7,8 –HxCDF	10.0	10
1,2,3, 6,7,8 –HxCDF	10.0	10
1,2,3, 7,8,9 –HxCDF	10.0	10
2,3, 4,6,7,8 –HxCDF	10.0	10
1,2,3,4, 6,7,8-HpCDF	20.0	20
1,2,3,4, 7,8,9-HpCDF	20.0	20
OCDF	20.0	20
Calibration mixture IV	¹² C congener's concentration ng/μL	¹³ C congener's concentration ng/μL (in Sampling, Internal, Syringe Standard)
1,2,3,4 – TCDD (Recovery/Syringe Standard)	----	10
2,3, 7,8-TCDD	30.0	10
1,2,3, 7,8-PeCDD	30.0	10
1,2,3, 4,7,8 –HxCDD	30.0	10
1,2,3, 6,7,8 –HxCDD	30.0	10
1,2,3, 7,8,9 -HxCDD	30.0	10
1,2,3,4, 6,7,8-HpCDD	60.0	20
OCDD	60.0	20
2,3, 7,8-TCDF	30.0	10
1,2,3, 7,8-PeCDF	30.0	10
2,3, 4,7,8-PeCDF	30.0	10
1,2,3, 4,7,8 –HxCDF	30.0	10
1,2,3, 6,7,8 –HxCDF	30.0	10
1,2,3, 7,8,9 –HxCDF	30.0	10
2,3, 4,6,7,8 –HxCDF	30.0	10
1,2,3,4, 6,7,8-HpCDF	60.0	20
1,2,3,4, 7,8,9-HpCDF	60.0	20
OCDF	60.0	20
Calibration mixture V	¹² C congener's concentration ng/μL	¹³ C congener's concentration ng/μL (in Sampling, Internal, Syringe Standard)
1,2,3,4 – TCDD (Recovery/Syringe Standard)	----	10
2,3, 7,8-TCDD	100.0	10
1,2,3, 7,8-PeCDD	100.0	10
1,2,3, 4,7,8 –HxCDD	100.0	10
1,2,3, 6,7,8 –HxCDD	100.0	10
1,2,3, 7,8,9 -HxCDD	100.0	10
1,2,3,4, 6,7,8-HpCDD	200.0	20
OCDD	200.0	20
2,3, 7,8-TCDF	100.0	10
1,2,3, 7,8-PeCDF	100.0	10
2,3, 4,7,8-PeCDF	100.0	10

1,2,3, 4,7,8 –HxCDF	100.0	10
1,2,3, 6,7,8 –HxCDF	100.0	10
1,2,3, 7,8,9 –HxCDF	100.0	10
2,3, 4,6,7,8 –HxCDF	100.0	10
1,2,3,4, 6,7,8-HpCDF	200.0	20
1,2,3,4, 7,8,9-HpCDF	200.0	20
OCDF	200.0	20

2.3 Daily Performance Check

- Calibration Check - Inject any level standard to the system. Calculate the relative response factor (RRF) for each compound and compare each RRF to the corresponding mean RRF obtained during the initial calibration. The analyzer performance is acceptable if the measured RRF's for the labeled and unlabeled compounds for the daily run are within the limits of the mean values of the method. In addition, the ion-abundance ratios shall be within the allowable control limits also. Next day calibration check is performed with next level calibration standard and thus all the calibration levels are updated during routine run.
- Column Separation Check - Inject a solution of a mixture of PCDD's and PCDF's that documents resolution between 2,3,7,8-TCDD and other TCDD isomers. Resolution is defined as a valley between peaks that is less than 25 percent of the lower of the two peaks. Identify and record the retention time windows for each homologous series. Perform a similar resolution check on the confirmation column to document the resolution between 2,3,7,8 TCDF and other TCDF isomers.
- Lock Channels - Set mass spectrometer lock channels. Monitor the quality control check channels to verify instrument stability during the analysis.
- Recovery Rates – For the determination of recovery rates defined quantities of two ¹³C₁₂-labelled recovery (Injection/Syringe/performance) standards are added after cleanup and prior to injection. The recovery rates of remaining standards are determined via the response factor of appropriate standards which are externally quantified.
- Sampling Train Collection Efficiency Check – The purpose of ¹³C₁₂ labelled Recovery (Surrogate / Sampling) standards addition prior to the sampling is to check the possible presence of any apparatus or handling errors. The recovery rates of these standards generally lie between 50 – 100% independent of any type of plant. Less than 50% efficiency suspect systematic errors. The results shall never be corrected to 100% in any case for sampling standards. It is only performed for quality assurance in sampling.

The Surrogate (Sampling) standards are quantified against the appropriate extraction standards as given in Table – 6a following the calculation as

$$R_{i\ sa} = \frac{100 * m_{i\ ex} * Q_{i\ sa}}{RRF_i * m_{i\ sa} * Q_{i\ ex}}$$

Where:

- $R_{i\ sa}$ – Recovery rate of the sampling standard i, in percent
- $m_{i\ ex}$ – mass of extraction standard i added to the sample
- $m_{i\ sa}$ – mass of sampling standard i added to the sample
- $Q_{i\ sa} / Q_{i\ ex}$ – Response ratio of sampling standard i and relevant extraction standard in the sample
- RRF_i – Relative Response Factor of the sampling standard i relative to the corresponding extraction (internal) standard i.

Table 6a: Calculation Scheme for the recovery rates of Surrogate (Sampling) Standards

Surrogate (Sampling) Standards	Internal (Extraction)
$^{13}C_{12-1,2,3, 7,8}$ -PeCDF	$^{13}C_{12-2,3, 4,7,8}$ -PeCDF
$^{13}C_{12-1,2,3, 7,8,9}$ -HxCDF	$^{13}C_{12-2,3, 4,6,7,8}$ –HxCDF
$^{13}C_{12-1,2,3,4, 7,8,9}$ -HpCDF	$^{13}C_{12-1,2,3,4, 6,7,8}$ -HpCDF

Internal Standard Percent Recoveries - A group carbon-labeled PCDDs and PCDFs representing the tetra- through octachlorinated homologues, is added to every sample prior to extraction. The role of the internal standards is to quantify the native PCDD's and PCDF's present in the sample as well as to determine the overall method efficiency. Recoveries of the internal standards must be between 40 to 130 percent for the tetra-through hexachlorinated compounds while the range is 25 to 130 percent for the hepta- and octachlorinated homologues.

The Extraction (Internal) standards are quantified against the appropriate Recovery (Syringe / Injection / Performance) standards as given in Table–6b following the calculation as

$$R_{i\ ex} = \frac{100 * m_{i\ sy} * Q_{i\ ex}}{RRF_i * m_{i\ ex} * Q_{i\ sy}}$$

Where:

- $R_{i\ ex}$ – Recovery rate of the extraction standard i, in percent
- $m_{i\ ex}$ – mass of individual extraction standard i added to the sample
- $m_{i\ sy}$ – mass of recovery (Syringe / Injection) standard i added to the sample
- $Q_{i\ ex} / Q_{i\ sy}$ – Response ratio of extraction standard i and relevant recovery (Syringe / Injection) standard in the sample
- RRF_i – Relative Response Factor of the extraction (internal) standard i relative to the corresponding recovery (Syringe / Injection) standard i.

Table 6b: Calculation Scheme for the recovery rates of Internal (Extraction) Standards

Internal (Extraction) Standards	Quantitative relative Recovery (Syringe/Injection/Performance) Standards
¹³ C ₁₂ -2,3, 7,8-TCDF ¹³ C ₁₂ -2,3, 7,8-TCDD	¹³ C ₁₂ -1,2,3, 4 TCDD ¹³ C ₁₂ -1,2,3, 4 TCDD
¹³ C ₁₂ -2,3, 4,7,8-PeCDF ¹³ C ₁₂ -1,2,3, 7,8-PeCDD	¹³ C ₁₂ -1,2,3, 4 TCDD ¹³ C ₁₂ -1,2,3, 4 TCDD
¹³ C ₁₂ -1,2,3, 4,7,8 -HxCDF ¹³ C ₁₂ -1,2,3, 6,7,8 -HxCDF ¹³ C ₁₂ -2,3, 4,6,7,8 -HxCDF ¹³ C ₁₂ -1,2,3, 4,7,8 -HxCDD ¹³ C ₁₂ -1,2,3, 6,7,8 -HxCDD	¹³ C ₁₂ -1,2,3, 7,8,9 -HxCDD ¹³ C ₁₂ -1,2,3, 7,8,9 -HxCDD ¹³ C ₁₂ -1,2,3, 7,8,9 -HxCDD ¹³ C ₁₂ -1,2,3, 7,8,9 -HxCDD ¹³ C ₁₂ -1,2,3, 7,8,9 -HxCDD
¹³ C ₁₂ -1,2,3,4, 6,7,8-HpCDF ¹³ C ₁₂ -1,2,3,4, 6,7,8-HpCDD	¹³ C ₁₂ -1,2,3, 7,8,9 -HxCDD ¹³ C ₁₂ -1,2,3, 7,8,9 -HxCDD
¹³ C ₁₂ -OCDF ¹³ C ₁₂ -OCDD	¹³ C ₁₂ -1,2,3, 7,8,9 -HxCDD ¹³ C ₁₂ -1,2,3, 7,8,9 -HxCDD

2.4 Final Calculation

Absolute values (ng) for all the target congeners are calculated considering every volumetric dilution factors. These individual absolute masses are divided by volume of Air collected during sampling to get individual concentrations (ng/Nm³) in flue gas. Finally individual concentrations of all the 17 toxic congeners are multiplied by respective I -TEF (International- Toxic Equivalent Factors) as mentioned in Table – 7 to derive I – TEQ (International- Toxic Equivalent). These individual I-TEQ values are then sum up to get Total I - TEQ value for the sample expressed as ng I-TEQ/NM³

Note: Report the concentration as corrected at 11 % O₂

Table 7: I-TEF (International- Toxic Equivalent Factors) for PCDDs and PCDFs

Target Toxic Congeners	I-TEQ values
2,3, 7,8-TCDD	1.0
1,2,3, 7,8-PeCDD	0.5
1,2,3, 4,7,8 -HxCDD	0.1
1,2,3, 6,7,8 -HxCDD	0.1
1,2,3, 7,8,9 -HxCDD	0.1
1,2,3,4, 6,7,8-HpCDD	0.01
OCDD	0.001
2,3, 7,8-TCDF	0.1

1,2,3, 7,8-PeCDF	0.05
2,3, 4,7,8-PeCDF	0.5
1,2,3, 4,7,8 -HxCDF	0.1
1,2,3, 6,7,8 -HxCDF	0.1
1,2,3, 7,8,9 -HxCDF	0.1
2,3, 4,6,7,8 -HxCDF	0.1
1,2,3,4, 6,7,8-HpCDF	0.01
1,2,3,4, 7,8,9-HpCDF	0.01
OCDF	0.001

Note: Report the concentration as corrected at 11% O₂ (as mentioned in the method for PM determination)

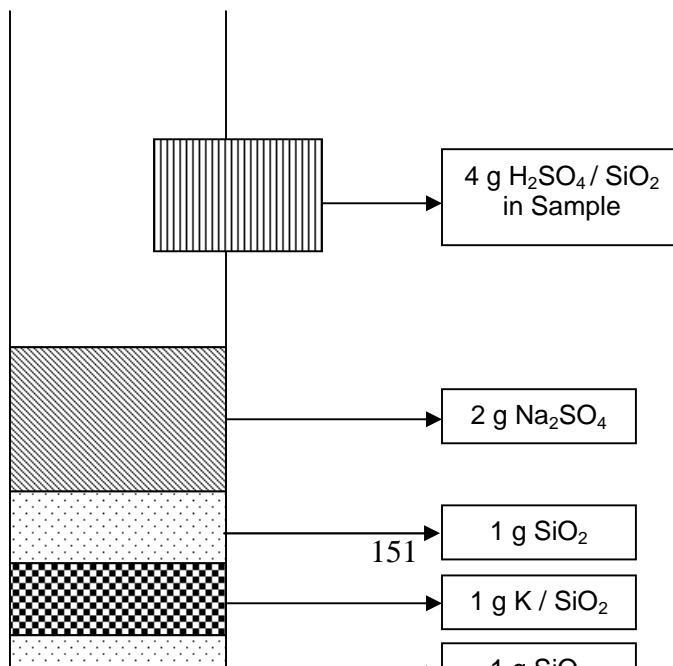

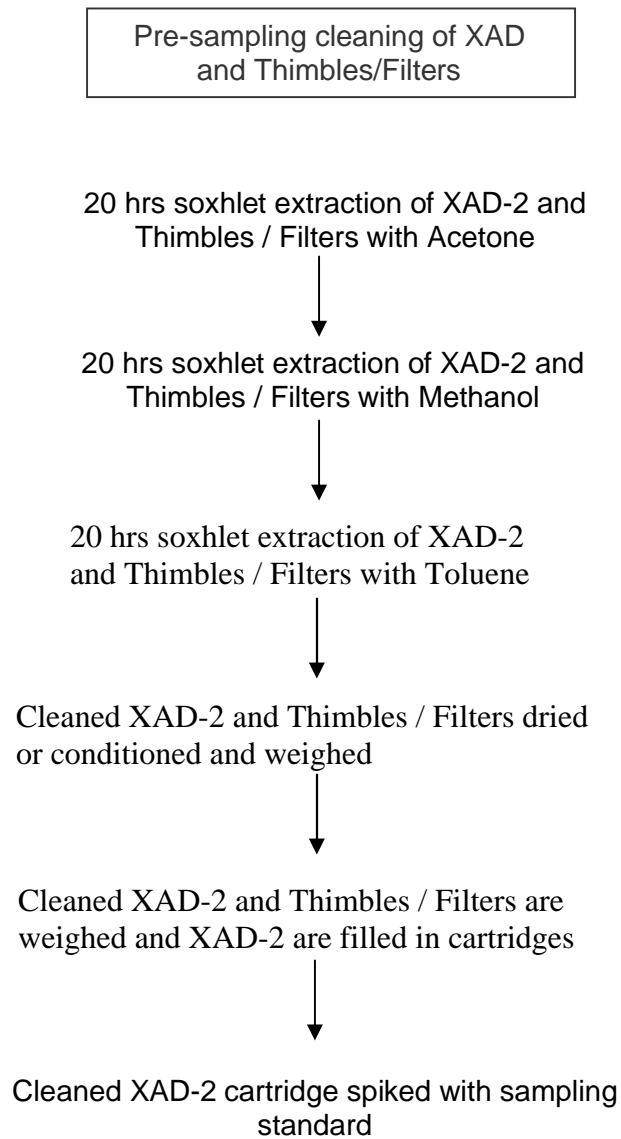

Figure 2: Pre-Sampling activities

EMISSION SAMPLE EXTRACTION

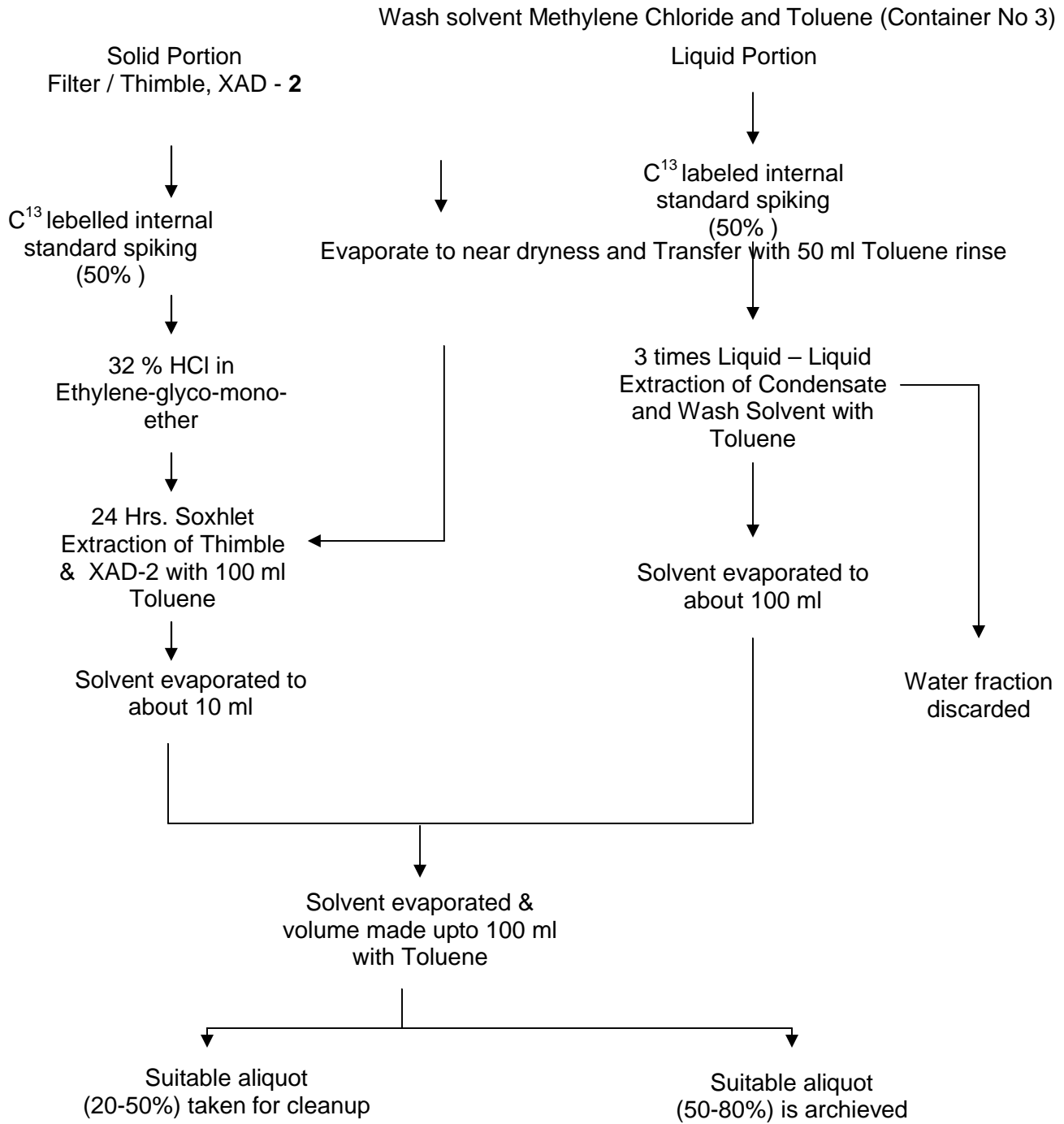

Figure 3: Schematic Sample Extraction Process

SAMPLE CLEAN UP DIOXINS & FURANS

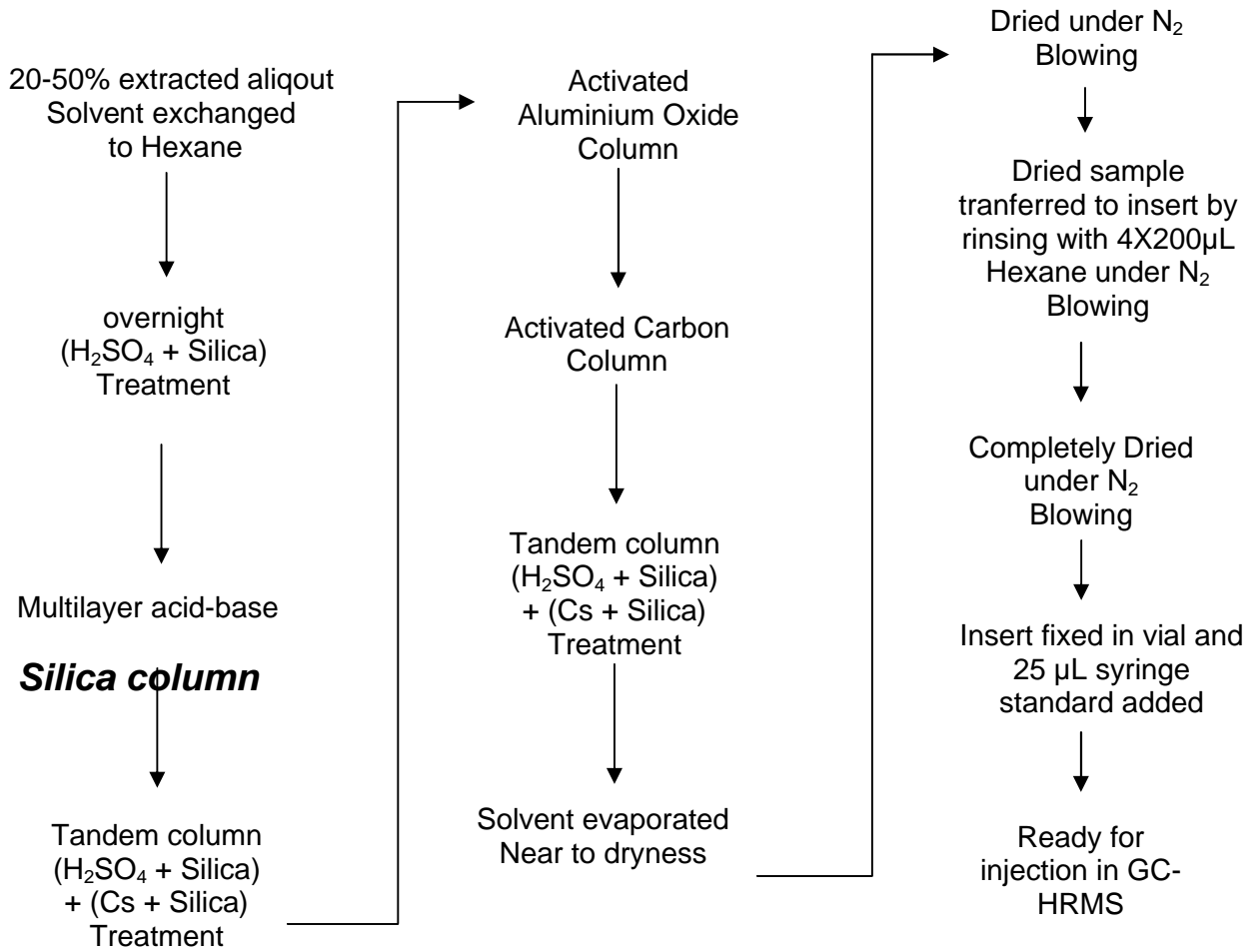

Figure 4: Schematic Sample Cleanup Process

10. REFERENCES

1. American Society of Mechanical Engineers. Sampling for the Determination of Chlorinated Organic Compounds in Stack Emissions. Prepared for U.S. Department of Energy and U.S. Environmental Protection Agency. Washington DC. December 1984. 25 p.
2. American Society of Mechanical Engineers. Analytical Procedures to Assay Stack Effluent Samples and Residual Combustion Products for Polychlorinated Dibenzo-p-Dioxins (PCDD) and Polychlorinated Dibenzofurans (PCDF). Prepared for the U.S. Department of Energy and U.S. Environmental Protection Agency. Washington, DC. December 1984. 23 p.
3. Thompson, J. R. (ed.). Analysis of Pesticide Residues in Human and Environmental Samples. U.S. Environmental Protection Agency. Research Triangle Park, NC. 1974.
4. Triangle Laboratories. Case Study: Analysis of Samples for the Presence of Tetra Through Octachloro-p-Dibenzodioxins and Dibenzofurans. Research Triangle Park, NC. 1988. 26 p.
5. U.S. Environmental Protection Agency. Method 8290 - The Analysis of Polychlorinated Dibenzo-p-dioxin and Polychlorinated Dibenzofurans by High-Resolution Gas Chromatography/High-Resolution Mass Spectrometry. In: Test Methods for Evaluating Solid Waste. Washington, DC. SW-846.
6. DIN EN 1948
7. VDI 3499, PAR – I