

Guidelines for the Measurement of Ambient Air Pollutants

Volume-I



Guidelines for Manual Sampling & Analyses



CENTRAL POLLUTION CONTROL BOARD
Ministry of Environment & Forests

Website: <http://www.cpcb.nic.in>

Guidelines for the Measurement of Ambient Air Pollutants

VOLUME-I



Guidelines for Manual Sampling & Analyses



CENTRAL POLLUTION CONTROL BOARD
Ministry of Environment & Forests
Parivesh Bhawan, East Arjun Nagar, Delhi- 110032
Website: <http://www.cpcb.nic.in>

CPCB, 300 Copies, 2013

Prepared & Published by PR Division, Central Pollution Control Board on behalf of
Sh. J. S. Kamyotra, Member Secretary, CPCB

Printing Supervision and Layout : Shri G. Ganesh, Ms. Anamika Sagar
and Shri Satish Kumar

Printed at Viba Press Pvt. Ltd.C-66/3, Okhla Industrial Area, Phase-II, New Delhi-110020



मीरा महर्षि
अध्यक्ष

MIRA MEHRISHI
Chairman

केन्द्रीय प्रदूषण नियंत्रण बोर्ड

(भारत सरकार का संगठन)
पर्यावरण एवं वन मंत्रालय

Central Pollution Control Board
(A Govt. of India Organisation)
Ministry of Environment & Forests
Phone : 22304948 / 22307233

FOREWORD

Air quality plays a vital role for health, safety and security of mankind and ecology. With increase in urbanization and industrialization, the air quality shows a deteriorating trend that poses threat to survival of many species, service life and aesthetic beauty of materials. Under the provisions of the Air (Prevention & Control of Pollution) Act, 1981, CPCB has notified National Ambient Air Quality Standards (NAAQS) in 2009. The revision aims at implementation of uniform air quality standards across the country, irrespective of the land use pattern.

The measurement methods prescribed in the notification for these parameters include combination of gravimetric, wet-chemical and continuous/real-time instrument techniques. To achieve uniformity in monitoring, quality assurance and quality control, data reporting as prescribed in NAAQS 2009, the CPCB has documented the following guidelines:

- Volume -I: Guidelines for the Measurement of Ambient Air Pollutants (Manual sampling and analyses), and
- Volume-II: Guidelines for the Measurement of Ambient Air Pollutants (Real time sampling and analyses)

Efforts made by the Scientists of Air Laboratory in compiling, collating and documenting these guidelines under the supervision of Dr. D. Saha, Scientist-D & I/c Air Laboratory and guidance of Shri J.S. Kamyotra, Member Secretary, CPCB is duly acknowledged.

I believe that these guidelines would be useful for bringing uniformity in air quality monitoring and data collection and compilation.

(Mira Mehrishi)

May 18, 2012

Contribution

Overall Guidance & Supervision

Sh. J. S. Kamyotra

Dr. D. Saha

Laboratory experiments & Drafting of Guidelines

Air Laboratory

Dr. D. Saha

Dr. S. K. Tyagi

Sh. A. K. Sen

Dr. R. C. Srivastava

Sh. A. Pathak

Sh. M. Satheesh

Sh. Ramesh Chand

Ms. Shaveta Kohli

Instrumentation Laboratory

Dr. Somendra Singh

Sh. B. K. Jena

Data Formats

Dr. D. Saha

Dr. R. C. Srivastava

Sh. M. Satheesh

Editing, Charts & Computer Setting

Dr. D. Saha

Sh. Fasiur Rehman

Ms. Shaveta Kohli

Background

Guidelines for Sampling and Measurement of notified Ambient Air Quality Parameters (NAAQS 2009)

Under the provisions of the Air (Prevention & Control of Pollution) Act, 1981, the CPCB has notified fourth version of National Ambient Air Quality Standards (NAAQS) in 2009. This revised national standard aims to provide uniform air quality for all, irrespective of land use pattern, across the country. There are 12 identified health based parameters, which are to measure at the national level and with a view to have data comparison, need for uniform guidelines for monitoring, sampling, analyses, sample flow chart, data sheet based on standard method has been felt.

The methods prescribed in the notification for respective parameters are the combination of physical method, wet-chemical method and continuous on-line method. Therefore, to meet the NAAQS requirement, a combination of both manual and continuous method is invariably required at each monitoring location, besides good laboratory set up and infrastructure.

In addition to the above, an in house exercise for applicability of all prescribed / recommended analytical methods was also felt necessary. After review and demonstration in the Central Laboratory, Delhi, guidelines are being prepared and documented, as under:

1. Volume -I: Guidelines for manual sampling and analyses (along with sample flow chart and data sheets);
2. Volume-II: Guidelines for continuous sampling and real time analyses

NATIONAL AMBIENT AIR QUALITY STANDARDS (2009)

Pollutants	Time Weighted Average	Concentration in Ambient Air		Methods of Measurement
		Industrial, Residential, Rural and other Areas	Ecologically Sensitive Area (Notified by Central Government)	
Sulphur Dioxide (SO ₂), µg/m ³	Annual *	50	20	-Improved West and Gaeke Method -Ultraviolet Fluorescence
	24 Hours **	80	80	
Nitrogen Dioxide (NO ₂), µg/m ³	Annual *	40	30	-Jacob & Hochheiser modified (NaOH-NaAsO ₂) Method -Gas Phase Chemiluminescence
	24 Hours **	80	80	
Particulate Matter (Size less than 10µm) or PM ₁₀ , µg/m ³	Annual *	60	60	-Gravimetric -TEOM -Beta attenuation
	24 Hours **	100	100	
Particulate Matter (Size less than 2.5µm) or PM _{2.5} , µg/m ³	Annual *	40	40	-Gravimetric -TEOM -Beta attenuation
	24 Hours **	60	60	
Ozone (O ₃) µg/m ³	8 Hours *	100	100	-UV Photometric -Chemiluminescence -Chemical Method
	1 Hour **	180	180	
Lead (Pb) µg/m ³	Annual *	0.50	0.50	-AAS/ICP Method after sampling on EPM 2000 or equivalent filter paper -ED-XRF using Teflon filter
	24 Hours **	1.0	1.0	
Carbon Monoxide(CO), mg/m ³	8 Hours **	02	02	-Non dispersive Infrared (NDIR) Spectroscopy
	1 Hour **	04	04	
Ammonia (NH ₃), µg/m ³	Annual *	100	100	-Chemiluminescence -Indophenol method
	24 Hours **	400	400	
Benzene (C ₆ H ₆), µg/m ³	Annual *	05	05	-Gas Chromatography (GC) based continuous analyzer -Adsorption and desorption followed by GC analysis
Benzo(a)Pyrene (BaP) Particulate phase only, ng/m ³	Annual *	01	01	-Solvent extraction followed by HPLC/GC analysis
Arsenic (As), ng/m ³	Annual *	06	06	-AAS/ICP Method after sampling on EPM 2000 or equivalent filter paper
Nickel (Ni), ng/m ³	Annual *	20	20	-AAS/ICP Method after sampling on EPM 2000 or equivalent filter paper

* Annual Arithmetic mean of minimum 104 measurements in a year at a particular site taken twice a week 24 hourly at uniform intervals.

** 24 hourly or 8 hourly or 1 hourly monitored values, as applicable, shall be complied with 98% of the time in a year. 2% of the time, they may exceed the limits but not on two consecutive days of monitoring.

NOTE: Whenever and wherever monitoring results on two consecutive days of monitoring exceed the limits specified above for the respective category, it shall be considered adequate reason to institute regular or continuous monitoring and further investigations.

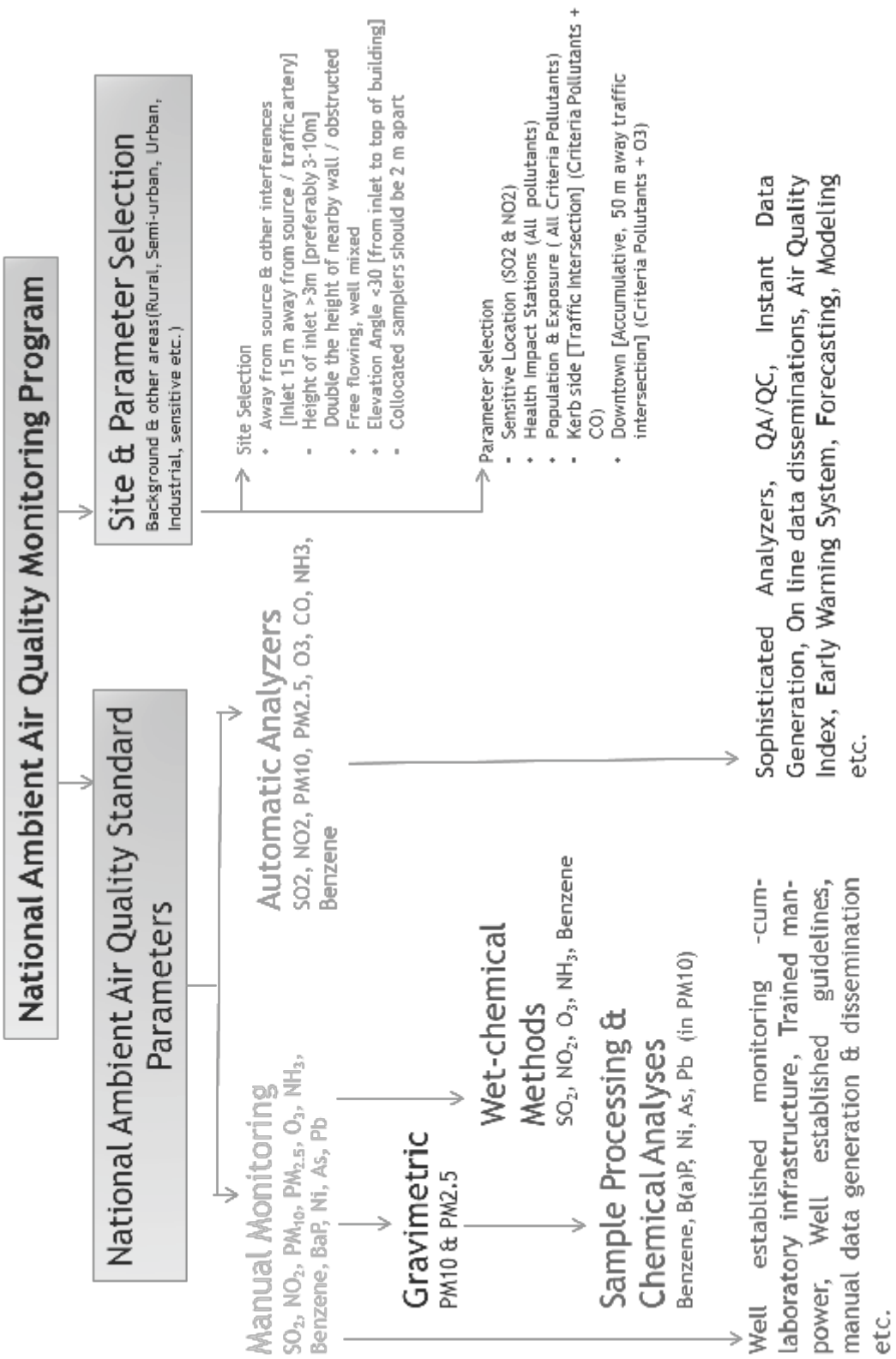

National Ambient Air Quality Monitoring Program

National Ambient Air Quality Standard Parameters & Methods

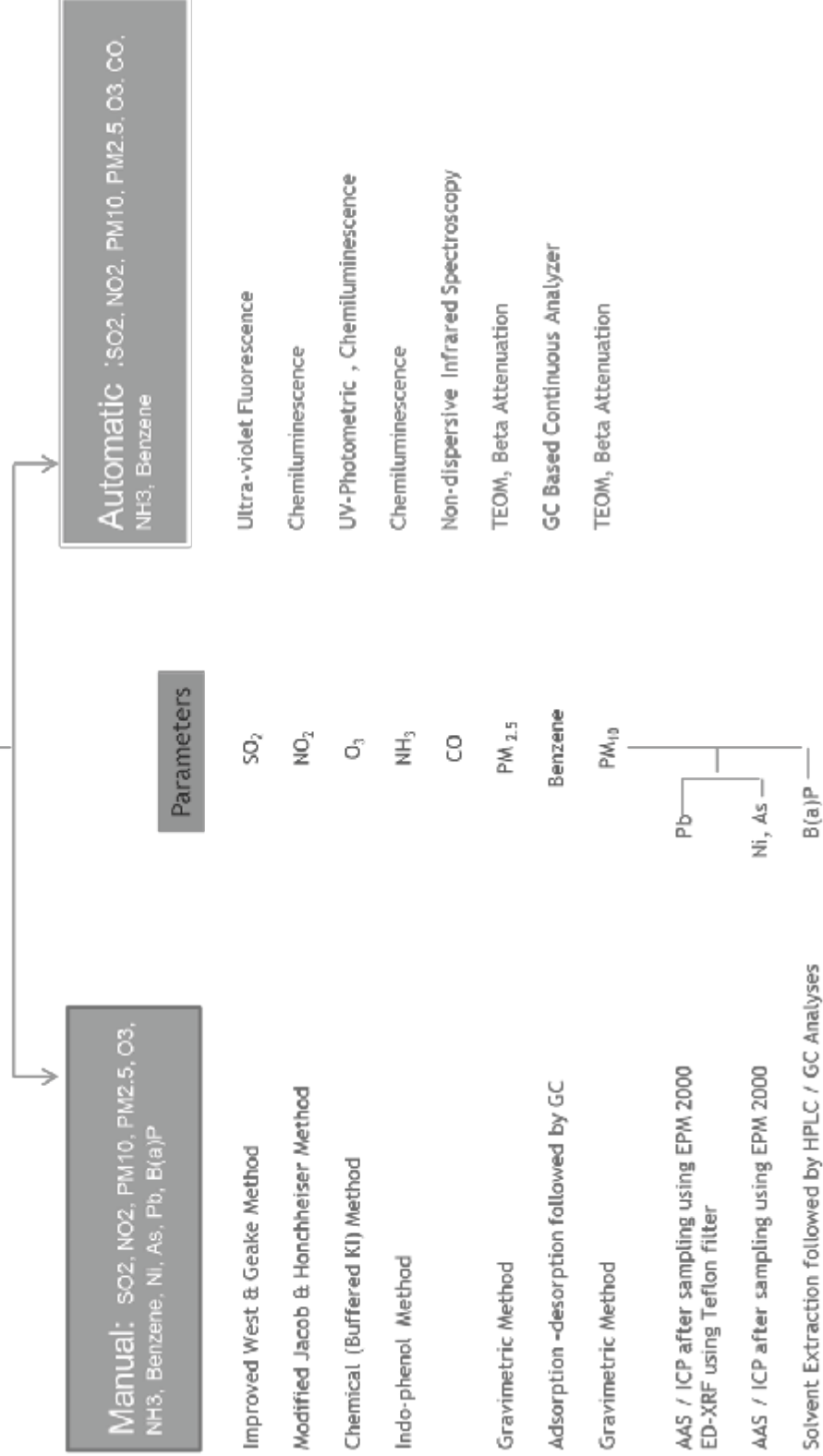

Contents

S.No.		Page
1.	Guidelines for sampling and analysis of sulphur dioxide in ambient air (Imporved Westand Gaeke Method)	1-6
2.	Guidelines for sampling and analysis of Nitrogen dioxide in ambient air (Modified Jacob and Hochheiser Method)	7-10
3.	Guidelines for sampling and analysis of Particulate Matter (PM10) in ambient air (Gravimetric Method)	11-14
4.	Guidelines for determination of PM2.5 in ambient air (Gravimetric Method)	15-30
5.	Guidelines for sampling and analysis protocol for ozone in ambient air (Chemical Method)	31-34
6.	Guidelines for sampling and analysis protocol for ammonia in ambient air (Indophenol Method)	35-39
7.	Guidelines for sampling and Analysis of Benzo(a)pyrene & other PAHs in Ambient Air (Solvent Extraction & GC Analysis)	40-47
8.	Guidelines for sampling and analysis of Lead, Nickel and Arsenic in ambient air (Atomic Absorption Spectrophotometer Method)	48-55
9.	Data sheets	A-P

Guidelines for sampling and analysis of sulphur dioxide in ambient air (Improved West and Gaeke Method)

1. Purpose

The purpose of this protocol is to provide guidelines for monitoring and analysis of sulphur dioxide in ambient air.

2. Standard

The national ambient air quality standards for sulphur dioxide is presented in the table

Pollutant	Time Weighted Average	Concentration in Ambient Air	
		Industrial, Residential, Rural and other Areas	Area (Notified by Central Government)
Sulphur Dioxide (SO ₂), µg/m ³	Annual *	50	20
	24 Hours **	80	80

* Annual Arithmetic mean of minimum 104 measurements in a year, at a particular site, taken twice a week 24 hourly at uniform intervals.

** 24 hourly or 8 hourly or 1 hourly monitored values, as applicable, shall be complied with 98% of the time in a year. 2% of the time, they may exceed the limits but not on two consecutive days of monitoring.

3. Principle of the method

Modified West & Gaeke Method (IS 5182 Part 2 Method of Measurement of Air Pollution: Sulphur dioxide).

Sulphur dioxide from air is absorbed in a solution of potassium tetrachloro-mercurate (TCM). A dichlorosulphitomercurate complex, which resists oxidation by the oxygen in the air, is formed. Once formed, this complex is stable to strong oxidants such as ozone and oxides of nitrogen and therefore, the absorber solution may be stored for some time prior to analysis. The complex is made to react with para-rosaniline and formaldehyde to form the intensely coloured pararosaniline methylsulphonic acid. The absorbance of the solution is measured by means of a suitable spectrophotometer

4. Instrument/Equipment

The following items are necessary to perform the monitoring and analysis of sulphur dioxide in ambient air:

- Analytical balance:

- Vacuum pump : Capable of maintaining an air pressure differential greater than 0.7 atmosphere at the desired flow rate
- Calibrated flow-measuring device to control the airflow from 0.2 to 1 l/min.
- Absorber: all glass midget impinger
- Spectrophotometer: Capable of measuring absorbance at 560 nm equipped with 1 cm path length cells.
- Glass wares: low actinic glassware must be used for analysis

5. Reagents/Chemicals

All the chemicals should meet specifications of Analytical Reagent grade

- Distilled water
- Mercuric chloride
- Potassium chloride / Sodium chloride
- EDTA di sodium salt
- Absorbing Reagent, 0.04 M Potassium Tetrachloro mercurate (TCM) - Dissolve 10.86 g, mercuric chloride, 0.066 g EDTA, and 6.0 g potassium chloride or 4.68 g sodium chloride in water and bring to the mark in a 1 litre volumetric flask. *Caution : highly poisonous if spilled on skin, flush off with water immediately.* The pH of this reagent should be approximately 4.0 but, it has been shown that there is no appreciable difference in collection efficiency over the range of pH 5 to pH 3. The absorbing reagent is normally stable for six months. If, a precipitate forms, discard the reagent after recovering the mercury.
- Sulphamic Acid (0.6%) - Dissolve 0.6 g sulphamic acid in 100 ml distilled water. Prepare fresh daily.
- Formaldehyde (0.2%) - Dilute 5 ml formaldehyde solution (36-38%) to 1 litre with distilled water. Prepare fresh daily.
- Purified Pararosaniline Stock Solution (0.2% Nominal) Dissolve 0.500 gm of specially purified pararosaniline (PRA) in 100 ml of distilled water and keep for 2 days (48 hours).
- Pararosaniline Working Solution - 10 ml of stock PRA is taken in a 250 ml volumetric flask. Add 15 ml conc. HCL and make up to volume with distilled water.
- Stock Iodine Solution (0.1 N) - Place 12.7 g iodine in a 250 ml beaker, add 40 g potassium iodide and 25 ml water. Stir until all is dissolved, then dilute to 1 litre with distilled water.
- Iodine Solution (0.01 N) - Prepare approximately 0.01 N iodine solution by diluting 50 ml of stock solution to 500 ml with distilled water.
- Starch Indicator Solution - Triturate 0.4 gm soluble starch and 0.002 g mercuric iodide preservative with a little water and add the paste slowly to 200 ml boiling water. Continue boiling until the solution is clear, cool, and transfer to a glass-stoppered bottle.
- Potassium iodate

- Stock Sodium Thiosulfate Solution (0.1 N) - Prepare a stock solution by placing 25 g sodium thiosulfate pentahydrate in a beaker, add 0.1 g sodium carbonate and dissolve using boiled, cooled distilled water making the solution up to a final volume of 1 litre. Allow the solution to stand one day before standardizing.

To standardize, accurately weigh to the nearest 0.1 mg, 1.5 g primary standard potassium iodate dried at 180°C, dissolve, and dilute to volume in a 500 ml volumetric flask. Into a 500 ml Iodine flask, transfer 50 ml of iodate solution by pipette. Add 2 g potassium iodide and 10 ml of N hydrochloric acid and stopper the flask. After 5 min, titrate with stock thiosulfate solution to a pale yellow. Add 5 ml starch indicator solution and continue the titration until the blue colour disappears. Calculate the normality of the stock solution.

- Sodium Thiosulphate Titrant (0.01 N) - Dilute 100 ml of the stock thiosulfate solution to 1 litre with freshly boiled and cooled distilled water.
- Standardized Sulphite Solution for Preparation of Working Sulphite-TCM Solution - Dissolve 0.30 g sodium metabisulphite ($\text{Na}_2\text{S}_2\text{O}_5$) or 0.40 g sodium sulphite (Na_2SO_3) in 500 ml of recently boiled, cooled, distilled water. Sulphite solution is unstable; it is, therefore, important to use water of the highest purity to minimize this instability. This solution contains the equivalent of 320-400 $\mu\text{g}/\text{ml}$ of SO_2 .
- Working Sulphite-TCM Solution - Measure 2 ml of the standard solution into a 100 ml volumetric flask by pipette and bring to mark with 0.04 M TCM. Calculate the concentration of sulphur dioxide in the working solution in micrograms of sulphur dioxide per millilitre. This solution is stable for 30 days if kept in the refrigerator at 5°C. If not kept at 5°C, prepare fresh daily.

6. Sampling

Place 30 ml of absorbing solution in an impinger and sample for four hours at the flow rate of 1 L/min. After sampling measure the volume of sample and transfer to a sample storage bottle.

7. Analysis

Replace any water lost by evaporation during sampling by adding distilled water up to the calibration mark on the absorber. Mix thoroughly, pipette out 10/20 ml of the collected sample into a 25 ml volumetric flask. Add 1 ml 0.6% sulphamic acid and allow reacting for 10 minutes to destroy the nitrite resulting from oxides of

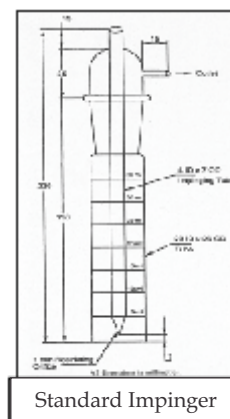

nitrogen. Add 2 ml of 0.2% formaldehyde solution and 2 ml pararosaniline solution and make up to 25 ml with distilled water. Prepare a blank in the same manner using 10 ml of unexposed absorbing reagent. After a 30 min colour development interval and before 60 minutes, measure and record the absorbance of samples and reagent blank at 560 nm. Use distilled water; not the reagent blank, as the optical reference

8. Calibration

The actual concentration of the sulphite solution is determined by adding excess iodine and back titrating with standard sodium thiosulfate solution. To back-titrate, measure, by pipette, 50 ml of the 0.01 N iodine solution into each of two 500 ml iodine flasks A and B. To flask A (blank) add 25 ml distilled water and into flask B (sample) measure 25 ml sulphite solution by pipette. Stopper the flasks and allow to react for 5 minutes. Prepare the working sulphite-TCM solution at the same time iodine solution is added to the flasks. By means of a burette containing standardized 0.01 N thiosulfate, titrate each flask in turn to a pale yellow. Then add 5 ml starch solution and continue the titration until the blue colour disappears.

8.1. Preparation of Standards

Measure 0.5 ml, 1.0 ml, 1.5 ml, 2.0 ml, 2.5 ml, 3.0 ml, 3.5 ml and 4.0 ml of working sulphite TCM solution in 25 ml volumetric flask. Add sufficient TCM solution to each flask to bring the volume to approximately 10 ml. Then add the remaining reagents as described in the procedure for analysis. A reagent blank with 10 ml absorbing solution is also prepared. Read the absorbance of each standard and reagent blank

8.2. Standard Curve

Plot a curve absorbance (Y axis) versus concentration (X axis). Draw a line of best fit and determine the slope. The reciprocal of slope gives the calibration factor (CF).

9. Calculation

Concentration of sulphite solution:

$$C = \frac{(V1-V2) \times N \times K}{V}$$

Where,

C = SO₂ concentration in µg/ml

V1 = Volume of thiosulfate for blank, ml

V2 = Volume of thiosulfate for sample, ml

- N = Normality of thiosulfate
K = 32000 (Milliequivalent weight SO₂/μg)
V = Volume of standard sulphite solution, ml

$$C (\text{SO}_2 \mu\text{g}/\text{m}^3) = (A_s - A_b) \times CF \times V_s / V_a \times V_t$$

Where,

C SO₂ = Concentration of Sulphur dioxide, μg/m³

A_s = Absorbance of sample

A_b = Absorbance of reagent blank

C_F = Calibration factor

V_a = Volume of air sampled, m³

V_s = Volume of sample, ml

V_t = Volume of aliquot taken for analysis, ml

10. Quality Control

Quality Control (QC) is the techniques that are used to fulfill requirements for quality. The QC procedures for the air sampling and monitoring sections of this protocol include preventative maintenance of equipment, calibration of equipment, analysis of field blanks and lab blanks.

11. Reference

IS 5182 Part 2 Method of Measurement of Air Pollution: Sulphur dioxide

FLOW CHART FOR MEASUREMENT OF SULPHUR DIOXIDE

Place 30 ml of absorbing media in an impinger



Connect it to the gas-sampling manifold of gas sampling device (RDS/HVS).



Draw air at a sampling rate of 1 lpm for four hours



Check the volume of sample at the end of sampling and record it



Transfer the exposed samples in storage bottle and preserve



Prepare calibration graph as recommended in method



Take 10/20 ml. aliquot of sample in 25 ml. Vol. Flask



Take 10/20 ml. of unexposed sample in 25 ml. Vol. Flask (blank)



Add 1 ml Sulphamic acid. Keep it 10 minutes



Add 2 ml formaldehyde



Add 2 ml working PRA



Make up to mark (25 ml.) with distilled water.



Keep it 30 minutes for reaction



Set Zero of spectrophotometer with Distilled water



Measure absorbance at 560 nm



Calculate concentration using calibration graph



Calculate concentration of Sulphur dioxide in $\mu\text{g}/\text{m}^3$

Guidelines for sampling and analysis of Nitrogen dioxide in ambient air (Modified Jacob and Hochheiser Method)

1. Purpose

The purpose of this protocol is to provide guidelines for monitoring of nitrogen dioxide in ambient.

2. Standard

The national ambient air quality standard for nitrogen dioxide is presented in the table:

Pollutant	Time Weighted Average	Concentration in Ambient Air	
		Industrial, Residential, Rural and other Areas	Ecologically Sensitive Area (Notified by Central Government)
Nitrogen dioxide (NO ₂), µg/m ₃	Annual *	40	30
	24 Hours **	80	80

* Annual Arithmetic mean of minimum 104 measurements in a year at a particular site taken twice a week 24 hourly at uniform intervals.

** 24 hourly or 8 hourly or 1 hourly monitored values, as applicable, shall be complied with 98% of the time in a year. 2% of the time, they may exceed the limits but not on two consecutive days of monitoring.

3. Principle of the method

Modified Jacob & Hochheiser Method (IS 5182 Part 6 Methods for Measurement of Air Pollution: Oxides of nitrogen).

Ambient nitrogen dioxide (NO₂) is collected by bubbling air through a solution of sodium hydroxide and sodium arsenite. The concentration of nitrite ion (NO₂) produced during sampling is determined colorimetrically by reacting the nitrite ion with phosphoric acid, sulfanilamide, and N-(1-naphthyl)-ethylenediamine dihydrochloride (NEDA) and measuring the absorbance of the highly coloured azo-dye at 540 nm.

4. Instrument/Equipment

The following items are necessary to perform the monitoring and analysis of nitrogen dioxide in ambient air:

- Analytical balance:
- Vacuum pump: Capable of maintaining a vacuum of at least 0.6 atmospheres

across the flow control device. Flow control device capable of maintaining a constant flow of 200-1000 ml per minute through the sampling solution.

- Calibrated flow measuring device: To control the airflow from 0.2 to 1 l/min.
- Absorber: a midjet impinger
- Spectrophotometer: Capable of measuring absorbance at 540 nm equipped with 1 cm path length cells.
- Glass wares: low actinic glassware must be used for analysis

5. Reagents/Chemicals

All the chemicals should meet specifications of ACS Analytical Reagent grade

- Distilled water
- Sodium hydroxide
- Sodium Arsenite
- Absorbing solution (Dissolve 4.0 g of sodium hydroxide in distilled water, add 1.0 g of sodium Arsenite, and dilute to 1,000 ml with distilled water)
- Sulphanilamide - Melting point 165 to 167°C
- N-(1-Naphthyl)-ethylenediamine Di-hydrochloride (NEDA) - A 1% aqueous solution should have only one absorption peak at 320 nm over the range of 260-400 nm. NEDA showing more than one absorption peak over this range is impure and should not be used
- Hydrogen Peroxide - 30%
- Phosphoric Acid - 85%
- Sulphanilamide Solution - Dissolve 20 g of sulphanilamide in 700 ml of distilled water. Add, with mixing, 50 ml of 85% phosphoric acid and dilute to 1,000 ml. This solution is stable for one month, if refrigerated
- NEDA Solution - Dissolve 0.5 g of NEDA in 500 ml of distilled water. This solution is stable for one month, if refrigerated and protected from light
- Hydrogen Peroxide Solution - Dilute 0.2 ml of 30% hydrogen peroxide to 250 ml with distilled water. This solution may be used for one month, if refrigerated and protected from light
- Sodium nitrite - Assay of 97% NaNO_2 or greater
- Sodium Nitrite stock solution (1000 $\mu\text{g NO}_2/\text{ml}$)
- Sodium Nitrite solution (10 $\mu\text{g NO}_2/\text{ml}$)
- Sodium Nitrite working solution (1 $\mu\text{g NO}_2/\text{ml}$) (Dilute with absorbing reagent, prepare fresh daily)

6. Sampling

Place 30 ml of absorbing solution in an impinger and sample for four hour at the flow rate of 0.2 to 1 L/min. After sampling measure the volume of sample and transfer to a sample storage bottle.

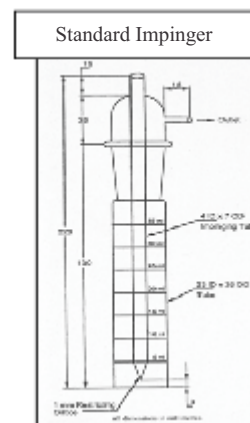

7. Analysis

Replace any water lost by evaporation during sampling by adding distilled water up to the calibration mark on the absorber, mix thoroughly.

Pipette out 10 ml of the collected sample into a 50 ml volumetric flask. Pipette in 1 ml of hydrogen peroxide solution, 10 ml of sulphanilamide solution, and 1.4 ml of NEDA solution, with thorough mixing after the addition of each reagent and make up to 50 ml with distilled water.

Prepare a blank in the same manner using 10 ml of unexposed absorbing reagent.

After a 10 min colour development interval, measure and record the absorbance of samples and reagent blank at 540 nm.

Use distilled water; not the reagent blank, as the optical reference

Samples with an absorbance greater than 1.0 must be re-analyzed after diluting an aliquot of the collected samples with an equal quantity of unexposed absorbing reagent.

A randomly selected 5-10% of the samples should be re-analyzed as apart of an internal quality assurance program.

8. Calibration

8.1. Preparation of Standards

Pipette 1, 2, 3, 4, 5, 6, 7, 8, 9, 10, 12, 15 and 20 ml of working standard solution in to 50 ml volumetric flask. Fill to 20 ml mark with absorbing solution. A reagent blank with 10 ml absorbing solution is also prepared. Add reagents to each volumetric flask as in the procedure for analysis. Read the absorbance of each standard and reagent blank against distilled water reference.

8.2. Standard Curve:

Plot a curve absorbance (Y axis) versus concentration (X axis). Draw a line of best fit and determine the slope. The reciprocal of slope gives the calibration factor (CF).

9. Calculation

$$C (\text{NO}_2 \mu\text{g}/\text{m}^3) = (A_s - A_b) \times \text{CF} \times V_s / V_a \times V_t \times 0.82$$

Where,

C NO₂ = Concentration of Nitrogen dioxide, μg/m³

A_s = Absorbance of sample

A_b = Absorbance of reagent blank

CF = Calibration factor

V_a = Volume of air sampled, m³

V_s = Volume of sample, ml

V_t = Volume of aliquot taken for analysis, ml

0.82 = Sampling efficiency

10. Quality Control

Quality Control (QC) is the techniques that are used to fulfil requirements for quality. The QC procedures for the air sampling and monitoring sections of this protocol include preventative maintenance of equipment, calibration of equipment, analysis of field blanks and lab blanks.

11. Reference

IS 5182 Part 6 Methods for Measurement of Air Pollution: Oxides of Nitrogen

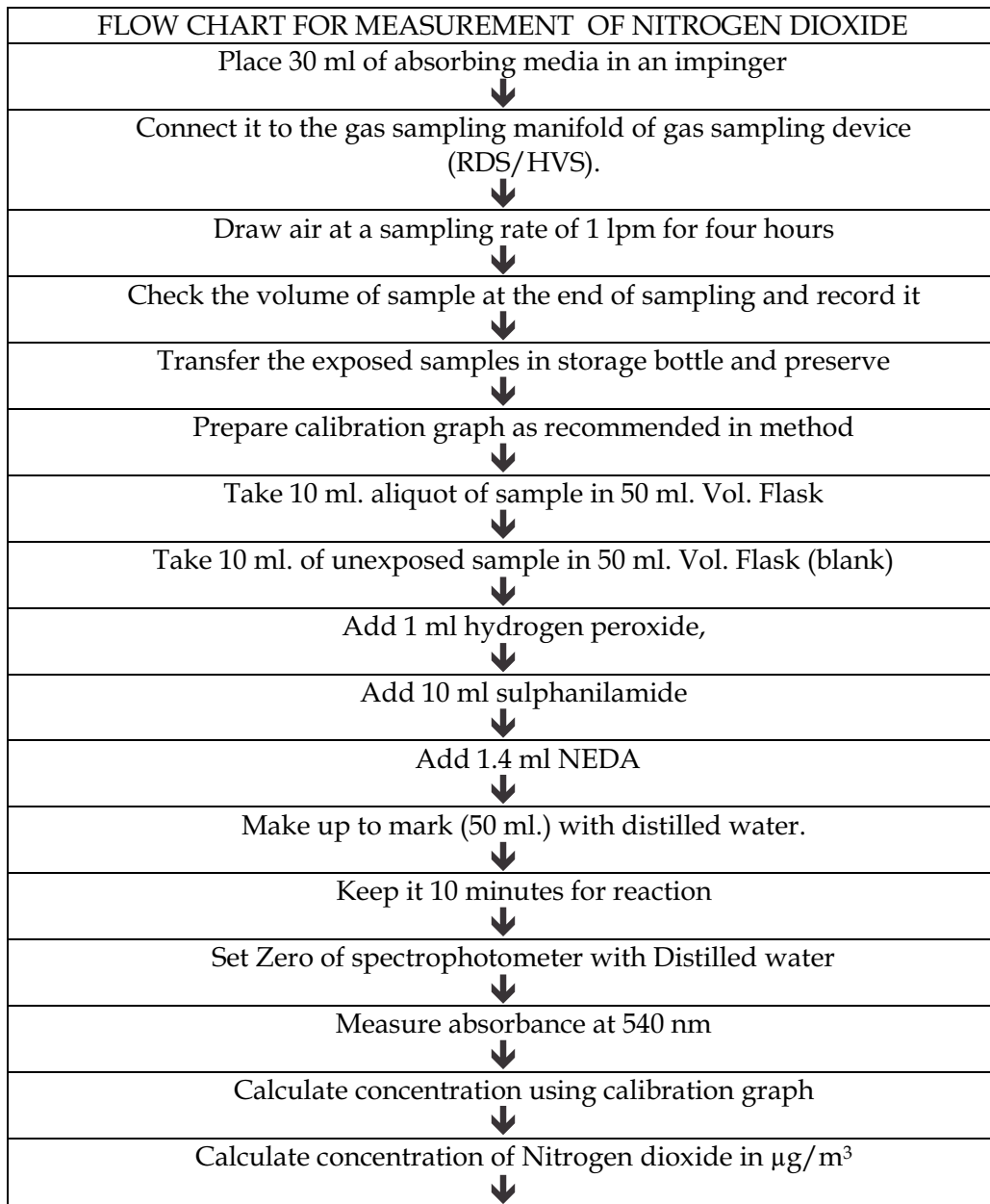

Guidelines for sampling and analysis of Particulate Matter (PM₁₀) in ambient air (Gravimetric Method)

1. Purpose

The purpose of this protocol is to provide guidelines for monitoring and analysis of Particulate Matter PM₁₀ in ambient air.

2. Standard

The national ambient air quality standards for Particulate Matter PM₁₀ is presented in the table

Pollutant	Time Weighted Average	Concentration in Ambient Air	
		Industrial, Residential, Rural and other Areas	Ecologically Sensitive Area (Notified by Central Government)
Particulate Matter, PM ₁₀ , µg/m ³	Annual * 24 Hours **	60	60
		100	100

* Annual Arithmetic mean of minimum 104 measurements in a year at a particular site taken twice a week 24 hourly at uniform intervals.

** 24 hourly or 8 hourly or 1 hourly monitored values, as applicable, shall be complied with 98% of the time in a year. 2% of the time, they may exceed the limits but not on two consecutive days of monitoring.

3. Principle of the method

Air is drawn through a size-selective inlet and through a 20.3 X 25.4 cm (8 X 10 in) filter at a flow rate, which is typically 1132 L/min. Particles with aerodynamic diameter less than the cut-point of the inlet are collected, by the filter. The mass of these particles is determined by the difference in filter weights prior to and after sampling. The concentration of PM₁₀ in the designated size range is calculated by dividing the weight gain of the filter by the volume of air sampled.

4. Instrument/Equipment

The following items are necessary to perform the monitoring and analysis of Particulate Matter PM₁₀ in ambient air:

- Analytical balance:
- Sampler : High Volume Sampler with size selective inlet for PM₁₀ and automatic volumetric flow control
- Calibrated flow-measuring device to control the airflow at 1132 l/min.
- Top loading orifice kit

5. Reagents / Chemicals

Filter Media - A Glass fibre filter of 20.3 X 25.4 cm (8 X 10 in) size

6. Sampling

Field Sampling - Tilt back the inlet and secure it according to manufacturer's instructions. Loosen the faceplate wing nuts and remove the faceplate. Remove the filter from its jacket and centre it on the support screen with the rough side of the filter facing upwards. Replace the faceplate and tighten the wing nuts to secure the rubber gasket against the filter edge. Gently lower the inlet. For automatically flow-controlled units, record the designated flow rate on the data sheet. Record the reading of the elapsed time meter. The specified length of sampling is commonly 8 hours or 24 hours. During this period, several reading (hourly) of flow rate should be taken. After the required time of sampling, record the flow meter reading, take out the filter media from the sampler, and put in a container or envelope.

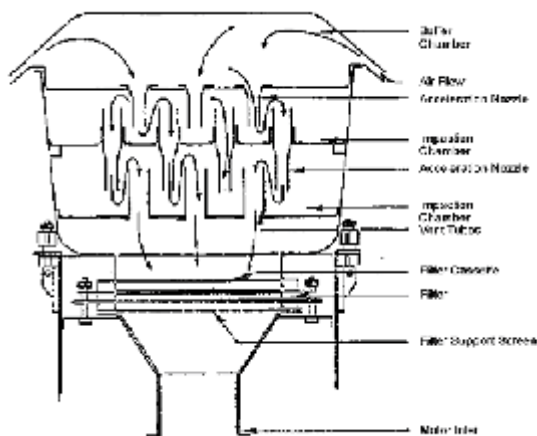

PM₁₀ Sampler (Impaction Inlet)

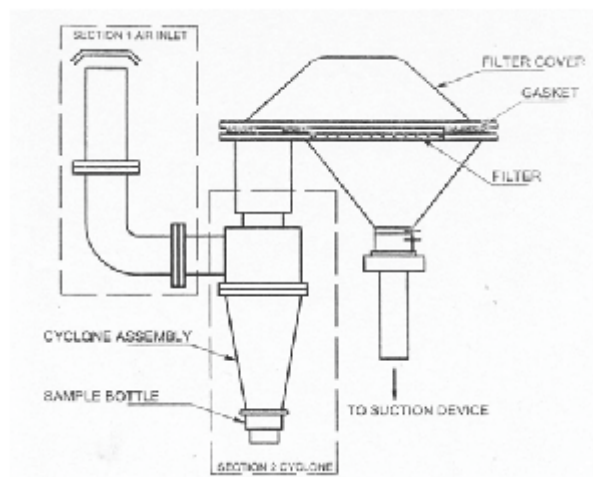

PM₁₀ Sampler (Cyclonic Inlet)

7. Analysis

Filter inspection: Inspect the filter for pin holes using a light table. Loose particles should be removed with a soft brush. Apply the filter identification number or a code to the filter if it is not a numbered. Condition the filter in conditioning room maintained within 20-30°C and 40-50% relative humidity or in an airtight desiccator for 24 hours. Take initial weight of the filter paper (W_i) before sampling. Condition the filter after sampling in conditioning room maintained within 20-30°C and 40-50% relative humidity or in an airtight desiccator for 24 hours. Take final weight of the filter paper (W_f)

8. Calibration

Periodical calibration of the sampler is being done by Orifice Transfer Standard - The PM₁₀ sampler calibration orifice consists of a 3.175 cm (1.25 in) diameter hole in the end cap of 7.62 cm (3 in) diameter by 20.3 cm (8 in) long hollow metal cylinder. This orifice is mounted tightly to the filter support in place of the inlet during calibration. A small tap on the side of the cylinder is provided to measure the pressure drop across the orifice. A flow rate of 1132 L/min through the orifice typically results in a pressure difference of several inches of water. The relationship between pressure difference and flow rate is established via a calibration curve derived from measurements against a primary standard such as a Roots meter at standard temperature and pressure. Flow resistances that simulate filter resistances are introduced at the end of the calibrator opposite the orifice by a set of perforated circular disks.

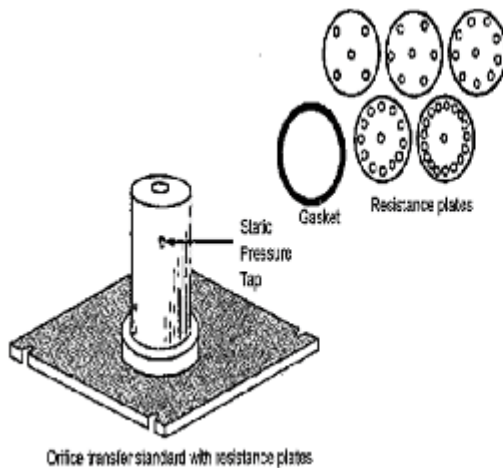

Top loading Orifice kit

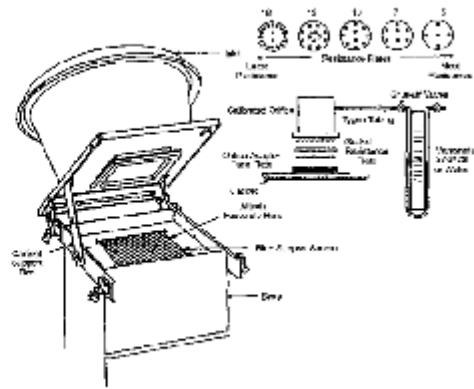

Calibration set up

9. Calculation

$$C_{PM_{10}} \mu\text{g}/\text{m}^3 = (W_f - W_i) \times 10^6 / V$$

Where,

$C_{PM_{10}}$ = Concentration of PM₁₀, $\mu\text{g}/\text{m}^3$

W_f = Initial weight of filter in g

W_i = Initial weight of filter in g

10^6 = Conversion of g to μg

V = Volume of air sampled, m^3

10. Quality Control

Quality Control (QC) is the techniques that are used to fulfill requirements for quality. The QC procedures for the air sampling and monitoring sections of this protocol

include preventative maintenance of equipment, calibration of equipment, analysis of field blanks and lab blanks.

11. Reference

- Method 501, Air Sampling and Analysis, 3rd Edition, Lewis publishers Inc.
- IS 5182 Part 23 Method of Measurement of Air Pollution: Respirable Suspended Particulate Matter (PM₁₀) cyclonic flow technique
- Method IO-2.1 Sampling of Ambient Air for Total Suspended Particulate Matter (SPM) and PM₁₀ Using High Volume (HV) Sampler

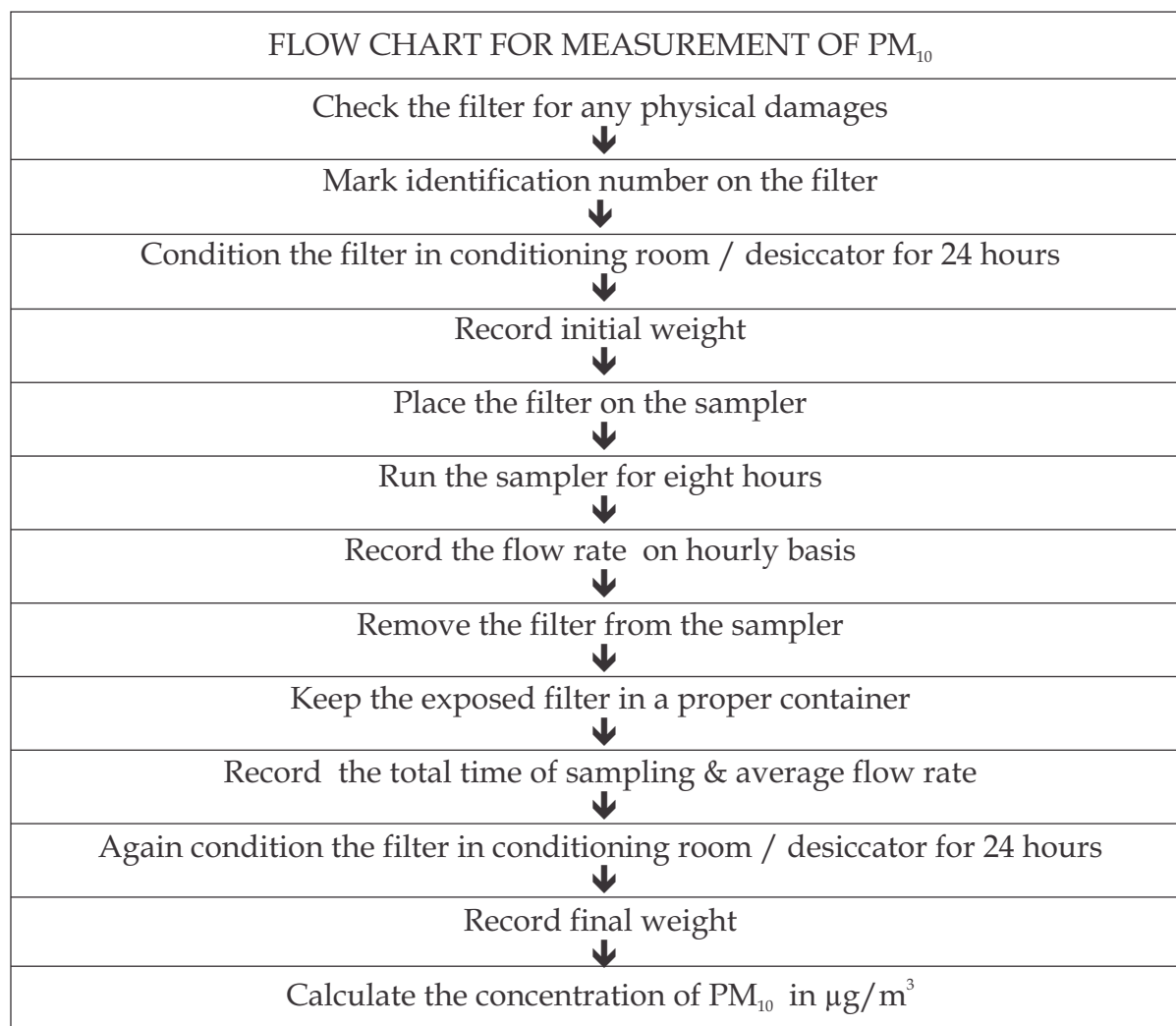

Guidelines for determination of PM_{2.5} in ambient air (Gravimetric Method)

1. Purpose

The purpose of this protocol is to provide guidelines for monitoring and analysis of Particulate Matter PM_{2.5} in ambient air.

2.0 Definition

PM_{2.5} refers to fine particles that are 2.5 micrometers (µm) or smaller in diameter. Ambient air is defined as any unconfined part of the Earth's atmosphere, that the surrounding outdoor air in which humans and other organisms live and breathe.

FRM - Federal Reference Method

FEM - Federal Equivalent Method

3.0 Standard

Pollutant	Time Weighted Average	Concentration in Ambient Air	
		Industrial, Residential, Rural and other Areas	Ecologically Sensitive Area (Notified by Central Government)
Particulate Matter, PM _{2.5} , µg/m ³	Annual *	40	40
	24 Hours **	60	60

* Annual Arithmetic mean of minimum 104 measurements in a year at a particular site taken twice a week 24 hourly at uniform intervals.

** 24 hourly or 8 hourly or 1 hourly monitored values, as applicable, shall be complied with 98% of the time in a year. 2% of the time, they may exceed the limits but not on two consecutive days of monitoring.

4.0 Principle

An electrically powered air sampler draws ambient air at a constant volumetric flow rate (16.7 lpm) maintained by a mass flow / volumetric flow controller coupled to a microprocessor into specially designed inertial particle-size separator (i.e. cyclones or impactors) where the suspended particulate matter in the PM_{2.5} size ranges is separated for collection on a 47 mm polytetrafluoroethylene (PTFE) filter over a specified sampling period. Each filter is weighed before and after sample collection to determine the net gain due to the particulate matter. The mass concentration in the ambient air is computed as the total mass of collected particles in the PM_{2.5} size ranges divided by the actual volume of air sampled, and is expressed in µg/m³. The microprocessor reads averages and stores five-minute averages of ambient temperature, ambient pressure,

filter temperature and volumetric flow rate. In addition, the microprocessor calculates the average temperatures and pressure, total volumetric flow for the entire sample run time and the coefficient of variation of the flow rate.

5.0 Interferences and Artefacts

The potential effect of body moisture or oils contacting the filters is minimized by using non-serrated forceps to handle the filters at all times. This measure also moderates interference due to static electricity.

Teflon filters accumulate a surface electrical charge, which may affect filter weight. Static electricity is controlled by treating filters with a "Static Master" static charge neutralizer prior to weighing. Placement of filters on a "Static Master" unit is required for a minimum of 30 seconds before any filter can be weighed.

Moisture content can affect filter weight. Filters must be equilibrated for a minimum of 24 hours in a controlled environment prior to pre- and post-weighing. The balance room's relative humidity must be maintained at a mean value range of 45 ± 5 % and its air temperature must be maintained at a mean value range of 25.0 ± 2.0 °C.

Airborne particulate can adversely affect accurate mass measurement of the filter. Filters undergoing conditioning should not be placed within an airflow path created by air conditioning ductwork, computer printers, or frequently opened doorways. Cleaning laboratory bench-tops and weighing areas daily, installing "sticky" floor mats at doorway entrances to the balance room and wearing clean lab coats over regular clothing can further minimize dust contamination.

5.1 Precision and Accuracy

The performance segment of the PM_{2.5} FRM specifies strict guidelines for controls that must be observed, as well as the range of precision and accuracy of those controls. The flow rate through the instrument is specified as 16.67 lpm (1 m³/hr). This flow must be volumetrically controlled to a precision of 5% and an accuracy of 2%. The flow control must be upgraded at least every 30 seconds and recorded (logged) every five minutes. Barometric pressure, ambient temperature and filter temperature should be measured on the same schedule. Filter temperature, it must not exceed the ambient temperature by more than 5° C for more than 30 minutes. A fan blowing filtered ambient air through the enclosure provides the necessary cooling effect. It is necessary for the entire apparatus to provide accurate performance over a temperature range of -20 to 50° C. The supporting run-time (interval) data, which are stored in detailed 5-minute intervals in the sampler's microprocessor, as well as 24-hour integrated performance (filter) data, must be capable of being extracted at the completion of a 24-hour run. The FRM mandates the provision of an RS232 port for this purpose. Data may be extracted to a portable computer.

Mass of the filter deposit, flow rate through the filter, and sampling time have typical precision of ± 0.2 mg, ± 5 %, and ± 30 seconds, respectively. These uncertainties combine

to yield a propagated precision of approximately $\pm 5\%$ at $10\ \mu\text{g}/\text{m}^3$ and approximately $\pm 2\%$ at $100\ \mu\text{g}/\text{m}^3$.

6.0 Sitting Requirements

Samplers should be sited to meet the goals of the specific monitoring project. For routine sampling to determine compliance with the National Ambient Air Quality Standards (NAAQS), sampler sitting is described in CPCB guidelines shall apply. The monitoring should be done at outside the zone of influence of sources located within the designated zone of representation for the monitoring site.

Height of the inlet must be 3 - 10 m above the ground level. And at a suitable distance from any direct pollution source including traffic.

Large nearby buildings and trees extending above the height of the monitor may present barriers or deposition surfaces for PM. Distance of the sampler to any air flow obstacle i.e. buildings, must be more than two times the height of the obstacle above the sampler.

There should be unrestricted airflow in three of four quadrants.

Certain trees may also be sources of PM in the form of detritus, pollen, or insect parts. These can be avoided by locating samplers by placing them $> 20\ \text{m}$ from nearby trees.

If collocated sampling has to be performed the minimum distance between two Samplers should be 2 m.

7.0 Apparatus and Materials

- Sampling equipment designated as FRM (Federal Reference Method) or FEM (Federal Equivalent Method)
- Certified Flow Transfer Standard for Flow Calibration
Following established EPA methods and procedures, all calibration transfer standards (i.e. temperature, pressure and flow) must be certified against traceable standards at least once per year. Calibration of these transfer standards will be conducted by the transfer standard manufacturer.
- Certified Standards for Pressure and Temperature (Optional)
- Electronic microbalance with a minimum resolution of 0.001 mg and a precision of $\pm 0.001\ \text{mg}$, supplied with a balance pan. The microbalance must be positioned on a vibration-damping balance support table.
- Calibration weights, utilized as Mass Reference Standards, should be non-corroding, range in weight from 100 mg to 200 mg, and be certified as traceable to NIST mass standards. The weights should be ASTM Class 1 category with a tolerance of 0.025 mg.
- Non-serrated forceps for handling filters.
- Non-metallic, non-serrated forceps for handling weights.
- Digital timer/stopwatch.

- 47 mm Filter: Teflon membrane, 46.2 mm effective diameter with a polypropylene support ring or filters as recommended by FRM / FEM sampler manufacturer.
- Filter support cassettes and covers.
- Filter equilibration racks.
- Relative Humidity / Temperature recorder.
- NIST-certified or ISO traceable Hygrometer for calibration of relative humidity readings.
- NIST-certified ISO traceable Thermometer for calibration of temperature readings.
- Light box.
- Radioactive (alpha particle) Polonium-210 ("Static Master") antistatic strips for static charge neutralization however static charge gives low-moderate interference in stability of reading of balance.
- Antistatic, nitrate-free, phosphate-free, sulphate-free, and powder free vinyl gloves.
- Plastic petri-slide filters containers (Filter Cassette).
- Zip-lock plastic bags, 6" 9".
- Disposable laboratory wipes.
- Filter equilibration cabinets.
- Impactor oil/grease

8.0 Sampling and Analytical Procedure

8.1 Calibration and performance check of Sampler

8.1.1 External Leak Check:

Upon initial installation of the sampler, following sampler repair or maintenance and at least monthly, perform a sampler external leak check according to the manufacturer's guidelines.

8.1.2 Internal Leak Check:

Upon initial installation of the sampler, following sampler repair or maintenance, and at least monthly, perform a sampler internal leak check according to the manufacturer's guidelines

8.1.3 Single-point Ambient Temperature and Filter Temperature Verification Check:

A single-point temperature verification check of both the ambient temperature and filter temperature sensors must be performed at least once every month. The Temperature check is performed following manufacturer's guidelines

8.1.4 Ambient Temperature Calibration:

The ambient temperature calibration is to be performed upon initial installation, yearly after site installation after any major maintenance that might affect the temperature reading, and at any time thereafter when the sampler fails a verification check following manufacturer's guidelines.

8.1.5 Filter Temperature Calibration

The filter temperature calibration is to be performed upon initial installation, yearly after site installation, and at any time thereafter when the sampler fails either a single-point or multi-point temperature verification check. To perform the temperature calibrations of filter follow the manufacturer's instructions.

8.1.6 Pressure Verification Check

Single-point pressure verification must be performed at least once every month. The pressure check is performed following manufacturer's instructions.

8.1.7 Pressure Calibration

The pressure calibration is to be performed upon initial installation, yearly after site installation, and at any time thereafter when the sampler fails a single-point pressure verification check. Pressure calibration shall be performed following manufacturer's instructions.

8.1.8 Single-point Flow Verification Check

A single-point flow verification check must be performed at least every month. The flow check is performed following manufacturer's instructions.

8.1.9 Multi-Point Flow Calibration Procedure

A multi-point flow calibration must be performed upon initial installation and once per year thereafter. In addition, the multi-point calibration must be performed whenever a single-point flow verification check indicates that the sampler flow deviates from the flow transfer standard by more than $\pm 4\%$. The multi-point calibration is performed following manufacturer's instructions.

8.2 Selection and Procurement of Filters

The quality of filter papers to be used should technically meet the desired specifications. It is preferable to prepare the estimate for whole requirement and order the same in bulk with a request to supply the same batch/lot of filters to control analytical quality and blank values. During the selection of filters following points should be considered:

- Mechanical stability;
- Chemical stability;
- Particle or gas sampling efficiency;
- Flow resistance;
- Loading capacity;
- Blank values;
- Artefact formation;
- Compatibility with analysis method; and
- Cost and availability.

47 mm (diameter) Teflon (PTFE) filter paper with Polypropylene support ring manufactured by M/s Whatman or M/s Pall Life Sciences or equivalent having 2 µm pore sizes. The filter papers should have very low background concentrations for ion and elements.

8.2.1 Filter Inspection and Conditioning of Filter Papers

Filter papers selected for different analytical objectives should be conditioned by following steps:

- Inspect all the filter papers for holes or cracks. Reject, if any deformity is found.
- Note down the batch/lot in log sheet.
- Label all the filters following a general lab coding technique, which should be unique to represent a sample.
- Put the marked filters in petri dishes.
- Use always proper (blunt) tweezers/forceps (made of non-reactive material) to handle the filter papers in lab and field as well.
- Prepare a sample-tracking sheet for each filter paper or a batch of filter paper.

8.2.2 Filter Inspection and Stability

To equilibrate, the filters are transferred from their sealed manufacturer's packaging to a filter-handling container such as a plastic petri-slide. The filters are handled with non-serrated forceps. Lab personnel must wear vinyl gloves as secondary when filters are being prepared for conditioning and weighing.

Before any filter is placed in a filter-handling container, it must be inspected for defects. This is done by an examination of the filter on a "light table". A filter must be discarded if any defects are identified. Specific defects to look for are:

- Pinhole - A small hole appearing as a distinct and obvious bright point of light when examined over a light table.
- Separation of ring - Any separation or lack of seal between the filter and the filter support ring.
- Chaff or flashing - Any extra material on the reinforcing ring or on the heat-seal area that would prevent an airtight seal during sampling.
- Loose materials - Any extra loose materials or dirt particles on the filter.
- Discoloration - Any obvious discoloration that might be evidence of contamination.
- Other - A filter with any imperfection not described above, such as irregular surfaces or other results of poor workmanship.

8.2.3 Filter Conditioning

A one-month storage period in a controlled environment, followed by one week equilibration in the weighing environment, found acceptable deviations in reweighing. Gravimetric measurement is the net mass on a filter by weighing the filter before and after sampling with a balance in a temperature and relative humidity controlled environment as described in Standard Operating Procedure. To minimize particle volatilization and aerosol liquid water bias, PM_{2.5} reference methods require that filters be equilibrated for 24 hours at a constant (within $\pm 5\%$) relative humidity 45 % and at a constant (within $\pm 2^\circ\text{C}$) temperature between 25°C . These filter equilibrium conditions are intended to minimize the liquid water associated with soluble compounds and to minimize the loss of volatile species.

8.2.4 Lot Blanks Check

Randomly select three filters as lot blanks from each new lot received and place in individual containers. Equilibrate the exposed filters in a filter equilibration cabinet in the Balance Room that allows air circulation, but still reduces extraneous airborne particles from settling on filters. Weigh lot blanks every 24 hours on a designated balance. Record the lot number, filter number, mass, and dates of the lot blanks in the assigned quality control logbook. Once the mass difference between weighing is less than 0.015 mg for all three lot blanks, the filters have stabilized. Note the time taken from initial exposure of the filters to attainment of mass stability. This information is designated as the minimum equilibration period required before filters from the same lot can be pre-

weighed and used for routine sampling. Once this minimum equilibration period is determined, the lot blanks become lab blanks which are set aside for long-term exposure in the same equilibration cabinet where routine samples, field blanks, and trip blanks are equilibrated prior to pre- or post-weighing.

8.2.5 Laboratory Conditions for Weighing

Gravimetric analysis of the filters needs to be performed with a microbalance. The sensitivity and reliability of the electro-balance is about + 0.001 mg or 1 µg. Though tolerances on re-weights of Teflon-membrane filters are typically ± 0.010 mg, these sensitive balances require isolation from vibration and air currents. Balances placed in laminar flow hoods with filtered air minimize contamination of filters from particles and gases in laboratory air. Electrostatic effects contribute another main interference in gravimetric analysis of filters. It is established that residual charge on a filter could produce an electrostatic discharge between the filter on the pan and the metal casing of the electro balance, which induces non-gravimetric forces. This charge can be removed from most filter media by exposing the filter to a low-level radioactive source (500 Pico curies of polonium210) prior to and during sample weighing.

8.3 Electro Balance Controls and Calibration

Gravimetric mass analysis is performed using single pan electronic balance. If possible, polonium strip ionization units are used to reduce electrostatic effects in the weighing cavity and on individual filters. A segregated laboratory area is used to control human traffic and to stabilize the temperature and relative humidity of the weighing environment. The area is cleaned with a high efficiency vacuum cleaner, and a tacky floor covering is installed at the entrance to the sample handling room to minimize dust artifact. Gravimetric analysis of filters currently uses the difference method to determine the mass of the collected aerosol. The pre weight of each filter is measured prior to being sent into the field for sampling. Once exposed and returned to the sample handling room, the filter is removed petri dishes and the post weight of the filter is measured after conditioning. The mass of the aerosol is determined by calculating the difference between the pre and post weights.

8.3.1 Cleaning and Maintenance of the Sample Handling Room

The requirements for a sample handling room include a reduced dust environment, and, over the twenty-four hour period prior to analysis of exposed filters, temperature in the range of 25° C with variation less than ± 3° C, and relative humidity 45% ±5%. Every last working day, the sample handling room should be thoroughly cleaned, after insuring that all filters have been

protected against contamination. To reduce fugitive dust levels, all surfaces are cleaned with a high efficiency vacuum. The floors are cleaned with a mild cleaning solution, if necessary. Finally, all work surfaces are cleaned with reagent grade alcohol (or another reagent grade solvent, if necessary) and Kimwipes™. This procedure reduces the possibility of contamination if a filter falls to the work surface. Following the Friday cleaning, no analysis shall occur for at least twenty-four hours to reduce the potential for contamination of filters by compounds used in the cleaning process.

8.3.2 Calibration and Maintenance of balance

The balance is cleaned and calibrated every day for ranges at the start of operation. It is also recalibrated if the balance fails a "zero" test that is performed periodically. A calibration log database is maintained for each balance. Significant events concerning the balance and any balance maintenance other than routine procedures are recorded in the log of the lab manager.

8.3.3 Cleaning

Regular cleaning should be performed as following:

- Clean the metal and plastic forceps with ethanol and a Kimwipe™.
- Clean the work surface around the balance with ethanol and a Kimwipe™.
- Clean the top surface and the strips of the anti static ionizing units by gently rubbing with a Kimwipe™ wetted with ethanol. Do not neglect to clean the ionizing unit in the electro balance.
- Replace the clean ionizing unit in the center back of the balance cavity, and close the door on the weighing chamber (if polonium strip is used).

8.3.4 Thorough Calibration of Balance (Once in 6 Months)

- o Allow the balance to stabilize with no weights on the pan. The computer will automatically record the mass to the screen when the balance has stabilized; this is the "zero" mass. It should be within 0.010 mg of 0.000. If not, contact the lab manager (see step 3, section 4.3.2.1 for lab manager procedures).
- o Set the zero on the balance by pressing the tare button on the balance. This forces the "zero" mass to be exactly 0.000.
- o Calibrate the balance. Momentarily ground yourself by touching the balance casing. Use nylon forceps to remove the certified calibration weight from its container. Gently place it in the center and allow the mass reading to stabilize and stop decreasing. Take readings.

- o Use a 200.000 mg or suitable mass of graded Calibration weight.
- o Use a 20.000 mg or suitable mass graded Calibration weight.
- o Remove the calibration weight from the bail, using the nylon forceps, and replace it in its storage container.
- o Check the calibration of the balance using the test weight. Momentarily ground yourself by touching the balance casing. Use the nylon forceps to remove the test weight from its container.
- o Place the test weight in the center of the balance pan and allow the mass reading to stabilize and stop decreasing. The computer will record a reading to the screen when the balance has stabilized. The test weight is an old 50.000 gm calibration weight.
- o Allow the balance to return to "zero." Compare the zero value and the value determined for the 50.000 mg mass to the expected values posted on the balance. If they exceed 02 micrograms, repeat the procedure. If variations greater than 10 micrograms are observed, report to the laboratory manager so that he/she can take appropriate action (section 4.3.2.1 step 3).
- o On a random basis, but at least semiannually, the laboratory supervisor shall request a comparison of the normal calibration standards with a master set of reference standard masses maintained by the laboratory supervisor. After calibration, measure these 200.000, 50.000, and 20.000 mg standards and report their masses to the supervisor. The results are used to verify the integrity of the electro balance and the standard masses used in daily calibrations.
- o The electro balance is available to run controls or for routine determination of mass.
- o Linearity checks (Once in a year otherwise after every repair/shifting of balance). To run a linearity check on the balance (if the balance is suspected to be damaged), utilize the series of four standard weights stored in the lab manager's desk. The four weights, 200 mg, 100 mg, 50 mg, and 20 mg, must be weighed and a regression line developed. Take following steps for performing Linearity checks:
 - o Use the nylon forceps to remove a weight from its container and place it on the weighing pan.
 - o Wait until the balance has stabilized (approximately one minute). Then, record the displayed weight as the 'y' value and the certified mass as the 'x' value.
 - o Remove the weight from the pan, using the plastic forceps, and replace it in its protective container.

- o Repeat steps (i) through (iii) for the other three weights.
- o Linearly regress the 'y' value versus the 'x' value. Calculate the r^2 value.
- o If the R^2 is not better than 0.995, the balance requires maintenance.

8.3.5 Stability Check of Balance (Once in Month)

To check the stability of the balance, reweigh the last 20 archived control filters, and develop a regression line comparing the re-weight values to the original values. Use following steps:

- Reweigh the series of 20 old controls filters on the suspect balance.
- Plot the re-weights versus the original weights.
- Derive the best line fit equation correlating the original weights to the re-weights.
- Calculate the standard deviation and the R^2 of the line fit.
- If the standard deviation is greater than ± 3 micrograms, and the R^2 is not better than 0.995, the balance should be carefully inspected and submitted for maintenance.

8.3.6 Daily Calibration of Balance

Internal Calibration should be performed daily before any Pre- or Post-sampling weighing.

8.3.7 Internal Calibration

Open the draft shield door for at least one minute to allow the balance-weighing chamber to equilibrate to room temperature, then, close the draft shield door. Press the "TARE" key when readout has stabilized to ensure zero-readout. The liquid crystal display (LCD) should display "0.000 mg". Press the key for ensuring the internal calibration.

8.3.8 External Calibration

Open the draft shield door. Place a 100 mg working reference standard calibration weight onto the microbalance pan with non-metallic forceps. Close the draft shield door. Record the date, temperature and relative humidity of the balance room, and mass readout in the quality control logbook assigned to the microbalance. Remove the calibration weight and tare the microbalance as described above. Enter the calibration data into logbook records and assign to

the calibration session in the quality control logbook assigned to the microbalance. External calibration must be performed for each day on which filters are pre-weighed and/or post-weighed.

8.3.9 Weighing of Filters

- o Take out pre-conditioned filters by forceps one by one and weigh properly. Record the mass in data sheet and log books against respective filter numbers or code. Always use gloved hands and blunt tweezers to handle filters.
- o Replace and close the filter container (Petri dishes). Weigh one Control Filters (Archived one) with each batch of ten weighing. Keep separate controls for Pre (Blank filter) and Post (Exposed) sampling filters.
- o Put the values of all control measurement in Quality Control Charts against dates.
- o Put Lab code on from Plastic petri-slide filter containers (Filter Cassette).
- o Take out conditioned filter from Plastic petri-slide filter containers (Filter Cassette).
- o Weigh the preconditioned filter.
- o Record and store it in laboratory coded filter cassette.
- o Follow the same procedure for exposed filter
- o Place the weighed filter into a petri-slide, close tightly, and store at 4°C for at least one year after sampling.

8.4 Shipment of Pre-weighed filters

Put the marked pre-weighed filters in Zip pouch. Transport the filters in a dry clean box (temperature control is optional) to the field.

8.5 Field sampling

- On the Field Data Log, fill in the top portion of the form including: the date/ time of visit, the site identification, sampler identification, site name, filter ID number, sample start and stop dates and times, and field operator initials.
- Perform all necessary pre-sampling procedures as described above.
- Perform QA/QC checks or maintenance, if required.
- Record all maintenance activities in the field log book; include time, date, and any concerns that might affect the quality of the sample.
- Remove the filter to be installed from its protective filter cassette carrier.
- Fix the filter following manufacturer's instructions into place against the bottom of the WINS impactor.
- Check the system clock and make sure it is within 1 min of NIST time.

- Strictly follow operator's manual for setting up the sampling programme (24 hours)
- The Filter Setup Screen shows the start date and time and the end date and time for the next sample. To change the sampling parameters follow the operator's manual
- Start Sampling run
- Wait until the auto diagnosis for all relevant parameters finishes and the sampler automatically switch over to SAMPLING mode. Check flow (16.7LPM) and Sample volume displays rightly on screen.

8.6 Recovering the Sample and Data from a Completed Sample Run

- From the Main Screen, note the current sampler-operating mode (top line, right side of display). If the sampler is in the WAIT mode or the SAMP (sampling) mode, the sampler has not completed the previously scheduled sampling run. Do not disturb the sampler unless necessary.
- If the sampler is in the DONE mode or the ERR mode, press STOP. This allows the sampler to write the final information into storage for the current sample run and must be performed prior to filter exchange. The sampler mode should now indicate STOP.
- Open the filter exchange mechanism by pulling straight back on the black handle. The filter holder will lower away from the WINS impactor.
- Remove the filter carrier from the filter holder.
- Place the filter carrier in the filter cassette case.
- From the Main Screen, access to the Filter Data screen following operator's instruction.
- Using the information displayed on the Filter Data screen, complete the Field Data Log with the following information from the completed sample run:
 - a) Total Sample Volume - from the Vol. field
 - b) Average Flow Rate - from the Ave. Flow field
 - c) Coefficient of Variation - from the %CV field
 - d) Total Run Time - from the Tot field
 - e) Maximum Temperature Difference - from the Temp Diff field
 - f) Minimum, Average and Maximum Ambient Temperatures - from the AmbT fields
 - g) Minimum, Average and Maximum Filter Temperatures - from the FltT fields
 - h) Minimum, Average and Maximum Pressures - from the Pres fields
 - i) If the sampler indicated there was an error, note the error in the field log book and make any repairs as needed. Any fixes should be done prior to the next run date.

8.7 Calculation and Reporting of Mass Concentrations

The equation to calculate the mass of fine particulate matter collected on a Teflon filter is as below:

$$M_{2.5} = (M_f - M_i) \text{ mg} \times 10^3 \mu\text{g}$$

Where,

$M_{2.5}$ = total mass of fine particulate collected during sampling period (μg)

M_f = final mass of the conditioned filter after sample collection (mg)

M_i = initial mass of the conditioned filter before sample collection (mg)

10^3 = unit conversion factor for milligrams (mg) to micrograms (μg)

- Field records of $\text{PM}_{2.5}$ samplers are required to provide measurements of the total volume of ambient air passing through the sampler (V) in cubic meters at the actual temperatures and pressures measured during sampling. Use the following formula if V is not available directly from the sampler:

$$V = Q_{\text{avg}} \times t \times 10^{-3} \text{ m}^3$$

Where,

V = total sample volume (m^3)

Q_{avg} = average flow rate over the entire duration of the sampling period (L/min)

t = duration of sampling period (min)

10^3 = unit conversion factor for liters (L) into cubic meters (m^3)

8.7.1 The equation given below can be used to determine $\text{PM}_{2.5}$ mass concentration:

$$\text{PM}_{2.5} = M_{2.5} / V$$

Where,

$\text{PM}_{2.5}$ = mass concentration of $\text{PM}_{2.5}$ particulates ($\mu\text{g}/\text{m}^3$)

$M_{2.5}$ = total mass of fine particulate collected during sampling period (μg)

V = total volume of air sampled (m^3)

9.0 Reporting

Data reporting should be done in prescribed Format. The Format shall contain all information including calibration. The data sheet must be accompanied by Sample Tracking sheet.

10.0 References

- 1.0 40 CFR Parts 53 and 58 Revised Requirements for Designation of Reference and Equivalent Methods for PM_{2.5} and Ambient Air Quality Surveillance for Particulate Matter; Final Rule
- 2.0 CARBSOP MLD 055
- 3.0 Aerosol Science & Technology: The PM_{2.5} Federal Reference Method (FRM)." 35(4):339-342
- 4.0 Federal Register/Vol. 72, No. 112/Tuesday, June 12, 2007/Rules and Regulations
- 5.0 PM_{2.5} Gravimetric Analysis - Revision 7, August 14, 2003, Page 2 of 24 RTI (Research Triangle Institute, US)

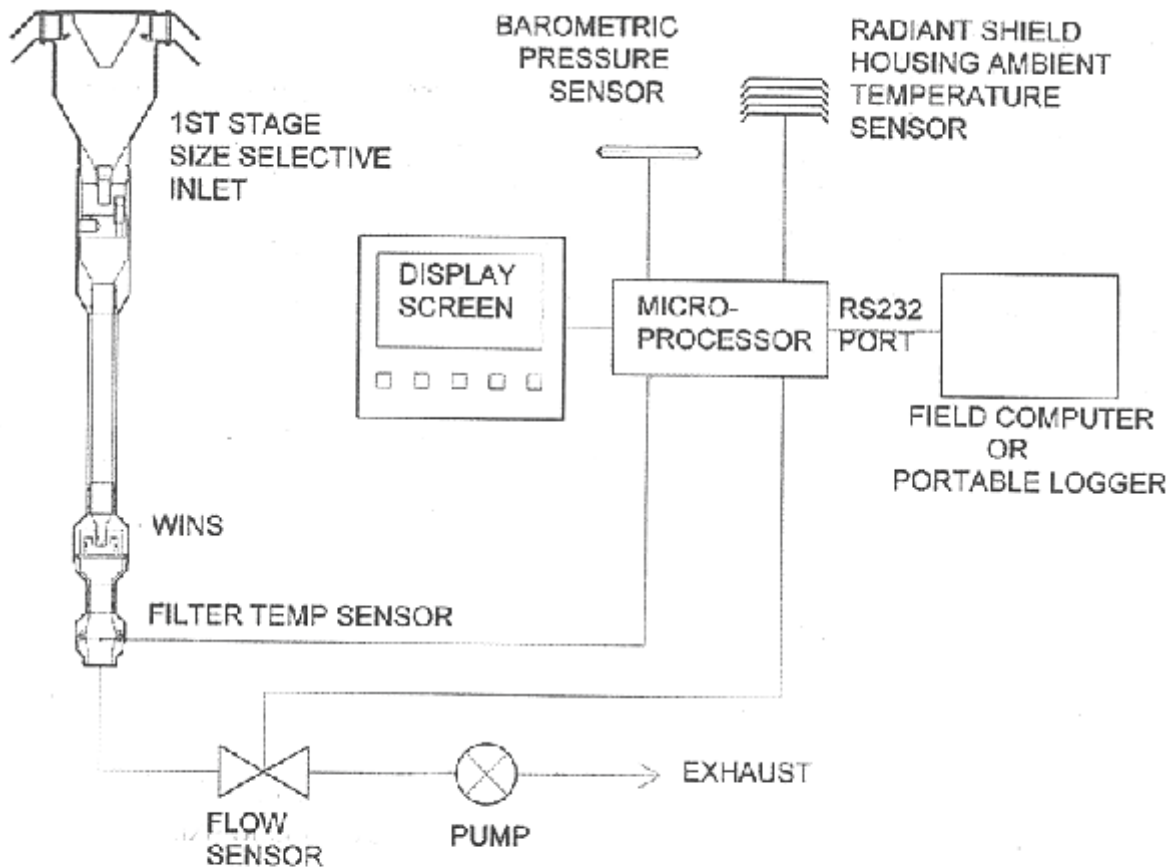

Figure 1. Schematic diagram of a single-channel PM_{2.5} FRM sampler.

FLOW CHART FOR MEASUREMENT OF PM_{2.5}

Check the filter for any physical damages



Mark identification number on the filter



Condition the filter in conditioning room / desiccator for 24 hours



Record initial weight



Place the filter on the sampler



Run the sampler for eight hours



Record the flow rate on hourly basis



Remove the filter from the sampler



Keep the exposed filter in a proper container



Record the total time of sampling & average flow rate



Again condition the filter in conditioning room / desiccator for 24 hours



Record final weight



Calculate the concentration of PM_{2.5} in $\mu\text{g}/\text{m}^3$

Guidelines for sampling and analysis for ozone in ambient air (Chemical Method)

1. Purpose

The purpose of this protocol is to provide guidelines for monitoring of ozone in ambient air.

2. Standard

The national ambient air quality standards for ozone is presented in the table

Pollutant	Time Weighted Average	Concentration in Ambient Air	
		Industrial, Residential, Rural and other Areas	Ecologically Sensitive Area (Notified by Central Government)
Ozone (O ₃), µg/m ³	8 Hours *	100	100
	1 Hour **	180	180

* Annual Arithmetic mean of minimum 104 measurements in a year at a particular site taken twice a week 24 hourly at uniform intervals.

** 24 hourly or 8 hourly or 1 hourly monitored values, as applicable, shall be complied with 98% of the time in a year. 2% of the time, they may exceed the limits but not on two consecutive days of monitoring.

3. Principle of the method

Method 411, Air Sampling and Analysis, 3rd Edition (Determination of oxidizing substances in the atmosphere)

Micro-amounts of ozone and the oxidants liberate iodine when absorbed in a 1% solution of potassium iodine buffered at pH 6.8 + 0.2. The iodine is determined spectrophotometrically by measuring the absorption of tri-iodide ion at 352 nm.

The stoichiometry is approximated by the following reaction:

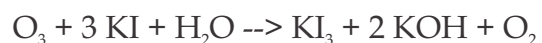

4. Instrument/Equipment

The following items are necessary to perform the monitoring and analysis of ammonia in ambient air:

- Analytical balance:
- Vacuum pump: Any suction pump capable of drawing the required sample flow rate of 1 to 2 litre per minute
- Calibrated flow measuring device to control the air flow from 1 to 2 l/min.
- Absorber: All glass midget impinger

- Spectrophotometer: Capable of measuring absorbance at 352 nm.
- Glass wares: low actinic glassware must be used for analysis

5. Reagents/Chemicals

All the chemicals should meet specifications of ACS Analytical Reagent grade

- Distilled water
- Absorbing Solution (1% KI in 0.1 m Phosphate Buffer) - Dissolve 13.6 g of potassium dihydrogen phosphate (KH_2PO_4), 14.2 g of disodium hydrogen phosphate (Na_2HPO_4) or 35.8 g of the dodecahydrate salt ($\text{Na}_2\text{HPO}_4 \cdot 12 \text{H}_2\text{O}$), and 10.0 g of potassium iodide in sequence and dilute the mixture to 1 L with water. Keep at room temperature for at least 1 day before use. Measure pH and adjust to 6.8 ± 0.2 with NaOH or KH_2PO_4 . This solution can be stored for several months in a glass stoppered brown bottle at room temperature without deterioration. It should not be exposed to direct sunlight.
- Stock Solution 0.025 M I_2 (0.05N) - Dissolve 16 g of potassium iodide and 3.173 g of re-sublimed iodine successively and dilute the mixture to exactly 500 ml with water. Keep at room temperature at least 1 day before use. Standardize shortly before use, against 0.025 M $\text{Na}_2\text{S}_2\text{O}_3$. The sodium thiosulfate is standardized against primary standard bi-iodate [$\text{KH}(\text{IO}_3)_2$] or potassium dichromate ($\text{K}_2\text{Cr}_2\text{O}_7$).
- M I2 Solution - Pipette exactly 4.00 ml of the 0.025 M Stock solution into a 100 ml low actinic volumetric flask and dilute to the mark with absorbing solution. Protect from strong light. Discard after use.

6. Sampling

Place 10 ml of absorbing solution in a standard impinger and sample for one hour at the flow rate of 1 L/min. Do not expose the absorbing reagent to direct sunlight. After sampling measure the volume of sample and transfer to a sample storage bottle.

7. Analysis

If, appreciable evaporation of the absorbing solution occurs during sampling, add water to bring the liquid volume to 10 ml. Within 30 to 60 minutes after sample collection, read the absorbance in a cuvette at 352 nm against a reference cuvette containing distilled water. Measure the absorbance of the unexposed reagent and subtract the value from the absorbance of the sample.

8. Calibration

8.1. Preparation of Standards

Calibrating Iodine Solution - For calibration purposes exactly 5.11 ml of the 0.001 M I₂ solution (or equivalent volume for other molarity) is diluted with absorbing solution just before use to 100 ml (final volume) to make the final concentration equivalent to 1 µl of O₃/ml. This solution preparation accounts for the stoichiometry described in Section 3 at standard conditions of 101.3 kPa and 25°C. Discard this solution after use.

Obtain a range of calibration points containing from 1 µl to 10 µl of ozone equivalent per 10.0 ml of solution. Prepare by individually adding 1.0, 2.0, 4.0, 6.0, 8.0 and 10.0 mL of the calibrating iodine solution to 10.0 ml volumetric flasks.

Bring each to the calibration mark with absorbing reagent.

Read the absorbance of each of the prepared calibration solutions at 352 nm against distilled water reference

8.2. Standard Curve

Plot a curve absorbance (Y axis) versus concentration (X axis). Draw a line of best fit and determine the slope. The reciprocal of slope gives the calibration factor (CF).

9. Calculation

$$C(\text{O}_3 \mu\text{g}/\text{m}^3) = (A_s - A_b) \times \text{CF} \times 1.962 / V_a$$

Where,

C O₃ = Concentration of Ozone in µg/m³

A_s = Absorbance of sample

A_b = Absorbance of reagent blank

CF = Calibration factor

V_a = Volume of air sampled in m³

1.962 = Conversion factor, µl to µg

10. Quality Control

Quality Control (QC) is the techniques that are used to fulfil requirements for quality. The QC procedures for the air sampling and monitoring sections of this protocol include preventative maintenance of equipment, calibration of equipment, analysis of field blanks and lab blanks.

11. Reference

Method 411, Air Sampling and Analysis, 3rd Edition (Determination of oxidizing substances in the atmosphere)

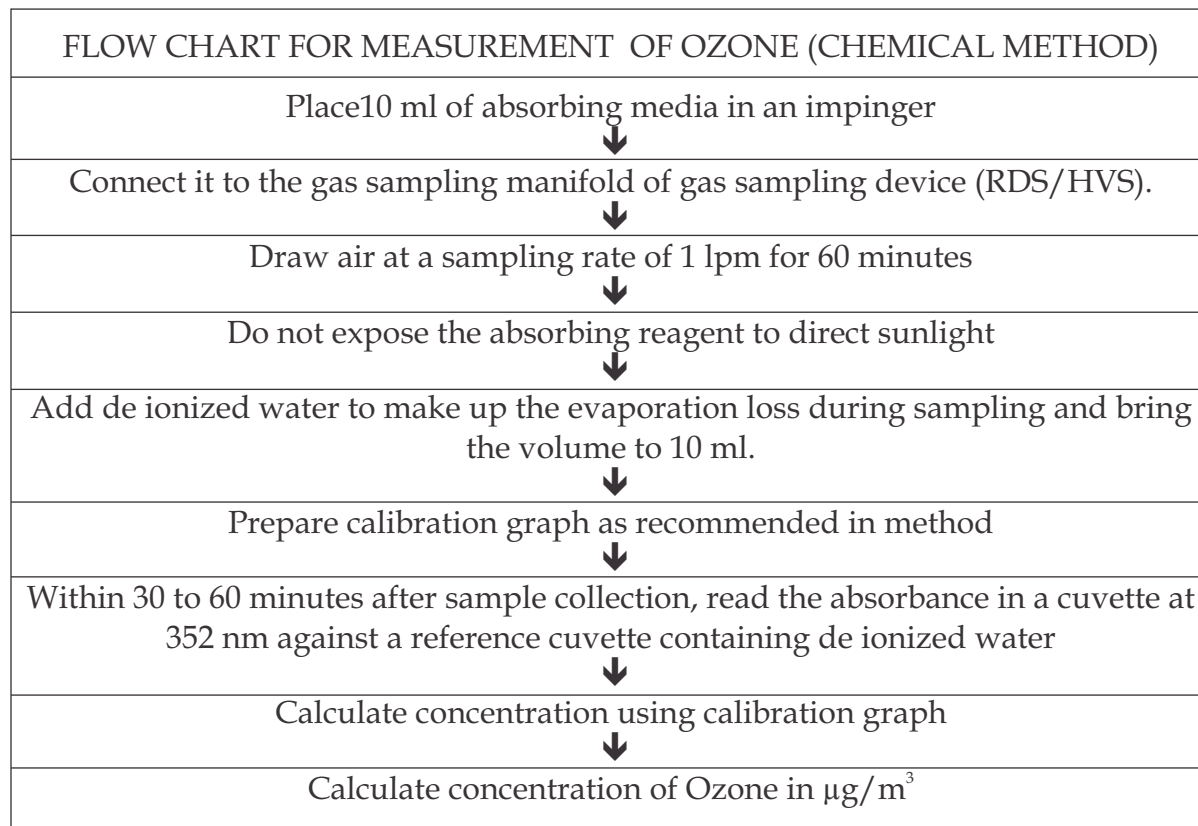

Guidelines for sampling and analysis for ammonia in ambient air (Indophenol Method)

1. Purpose

The purpose of this protocol is to provide guidelines for monitoring of ammonia in ambient air.

2. Standard

The national ambient air quality standard for ammonia is presented in the table:

Pollutant	Time Weighted Average	Concentration in Ambient Air	
		Industrial, Residential, Rural and other Areas	Ecologically Sensitive Area (Notified by Central Government)
Ammonia (NH ₃), µg/m ³	Annual *	100	100
	24 Hours **	400	400

* Annual Arithmetic mean of minimum 104 measurements in a year at a particular site taken twice a week 24 hourly at uniform intervals.

** 24 hourly or 8 hourly or 1 hourly monitored values, as applicable, shall be complied with 98% of the time in a year. 2% of the time, they may exceed the limits but not on two consecutive days of monitoring.

3. Principle of the method

Indophenol method (Method 401, Air Sampling and Analysis, 3rd Edition) Ammonia in the atmosphere is collected by bubbling a measured volume of air through a dilute solution of sulphuric acid to form ammonium sulphate. The ammonium sulphate formed in the sample is analyzed colorimetrically by reaction with phenol and alkaline sodium hypochlorite to produce indophenol, a blue dye. The reaction is accelerated by the addition of sodium nitroprusside as catalyst.

4. Instrument/Equipment

The following items are necessary to perform the sampling and analysis of ammonia in ambient air:

- Analytical balance
- Vacuum pump: To maintain a flow rate up to 5 litre per minute
- Flow measuring device: Calibrated flow meter to control the air flow from 1 to 21/min.

- Absorber: A midjet impinger or a fritted bubbler
- Spectrophotometer: Capable of measuring absorbance at 630 nm.
- Glass ware: Low actinic glass wares must be used for analysis.

5. Reagents/Chemicals

All the chemicals should meet specifications of ACS Analytical Reagent grade

- Distilled water
- 0.1N Sulphuric Acid (Absorbing solution): Dilute 3.0ml of concentrated H_2SO_4 (18 M) to 1 litre with distilled water.
- Sodium nitroprusside: Dissolve 2 g sodium nitroprusside in 100 ml distilled water. The solution keeps well in the refrigerator for 2 months.
- 6.75 M sodium hydroxide: Dissolve 270 g sodium hydroxide in about 1 litre of distilled water. Boil down to 600 ml. Cool and fill to 1 litre. Store in polyethylene bottle.
- Sodium hypochlorite solution: Dilute 5 to 6% AR grade sodium hypochlorite with distilled water to give a 0.1N solution (0.37%). Strength determined before dilution by iodometric titration using 0.1N standardized sodium thiosulfate solution or colorimetry after appropriate dilution.
- Stock sodium thiosulphate solution (0.1 N): Prepare the solution by placing 25g sodium thiosulfate pentahydrate, add 0.1g sodium carbonate and dissolve using boiled, cooled distilled water making the solution up to a final volume of 1litre. Allow the solution to stand one day before standardizing.

Standardization of sodium thiosulfate solution:

To standardize, accurately weigh to the nearest 0.1 mg, 1.5g primary standard potassium iodate dried at 180°C, dissolve and dilute to volume in 500ml volumetric flask.

Into a 500ml Iodine flask, transfer 50 ml of iodate solution by pipette. Add 2 g potassium iodide and 10 ml of N hydrochloric acid and stopper the flask. After 5 min, titrate with stock thiosulfate solution to pale yellow. Add 5ml starch indicator solution and continue the titration until the blue colour disappears. Calculate the normality of the stock solution.

- Phenol solution 45% v/v: Dilute 45 ml Phenol to 100 ml with methanol
- Sodium phosphate
- Ammonium chloride or Ammonium sulfate
- Hydrochloric acid
- Buffer Solution: Dissolve 50 g of sodium phosphate ($Na_3PO_4 \cdot 12 H_2O$) and 74 ml of 6.75 M NaOH in 1 L of distilled water
- Working hypochlorite solution: Mix 30 ml of 0.1 N sodium hypochlorite and 30 ml of 6.75 M Sodium hydroxide and dilute to 100 ml with distilled water
- Working Phenol solution: Mix 20 ml of 45% phenol solution with 1 ml of 2% sodium nitroprusside and dilute to 100 ml with distilled water.

- Ammonia stock solution (1 mg NH₃/ml)
- Ammonia working solution (10 µg NH₃/ml) (Prepare fresh daily)

6. Sampling

Place 10 ml of absorbing solution in an impinger and sample for one hour at the flow rate of 1 to 2 L/min. After sampling measure the final volume of sample and transfer to a sample storage bottle.

7. Analysis

Transfer contents of the sample bottle to a 25 ml glass stopper graduated cylinder. Maintain all the solutions and sample at 25°C. To the reagent blank, control and samples add 2 ml buffer, 5 ml of working phenol solution, mix, and fill to about 22 ml. with distilled water, then add 2.5 ml of working hypochlorite solution and rapidly mix. Dilute to 25 ml, mix and store in the dark for 30 minutes to develop colour. Measure the absorbance of the solution at 630 nm on a spectrophotometer using 1 cm cells.

8. Calibration and standardization

8.1. Preparation of Standards

Pipet 0.5, 1.0, 1.5, 2.0 ml of working standard solution in to 25 ml glass stoppered graduated cylinders. Fill to 10 ml mark with absorbing solution. A reagent blank with 10 ml absorbing solution is also prepared. Add reagents to each cylinder as in the procedure for analysis. Read the absorbance of each standard against reagent blank.

8.2. Standard Curve

Plot the absorbance as the ordinate (Y axis) versus concentration as the abscissa (X axis). Draw a line of best fit and determine the slope.

9. Calculation

$$C(\text{NH}_3 \mu\text{g}/\text{m}^3) = (A_s - A_b) \times \text{CF} \times V_s / V_a \times V_t$$

Where,

C_{NH₃} = Concentration of Ammonia in µg/m³

A_s = Absorbance of sample

A_b = Absorbance of reagent blank

CF = Calibration factor

V_a = Volume of air sampled in m³

V_s = Final volume of the sample in ml

V_t = Volume of the aliquot taken for analysis, ml

10. Quality Control

Quality Control (QC) is the technique that is used to fulfill requirements for quality. The QC procedures for the air sampling and monitoring sections of this protocol include preventative maintenance of equipment, calibration of equipment, analysis of field blanks and lab blanks.

Randomly selected 5-10% samples should be reanalysed as a part of internal quality assurance program.

11. Reference

Indophenol method (Method 401, Air Sampling and Analysis, 3rd Edition), Lewis publishers Inc.

FLOW CHART FOR MEASUREMENT OF AMMONIA

Dilute 10ml of concentrated HCl (12M) to 100 ml with distilled water
Wash the glassware with the water and finally rinse it thrice with distilled water



Adjust the Flow rate at 1L/min of the rotameter and the manifolds of the attached
APM 411/APM 460Dx



Place 10 ml of absorbing media in each midget impinger for samples and field
blanks

Assemble (in order) prefilter & holder, flowmeter, impinger and pump
Sample at the rate of 1L/min for 1hour duration



Record the sampling time, average flow rate and final volume of the solution
After the sample collection, transfer the solution in the impinger to polyethylene
bottle and recap it tightly for transport to laboratory for analysis



Prepare the absorbing media, various reagents and working solutions as per the
method described in protocol
Standardize the sodium thiosulphate solution by titrating it against potassium
iodate and Sodium hypochlorite by titrating it against standardized sodium
thiosulphate solution



Take 25 ml measuring flasks and rinse with distilled water. Transfer the contents
from polyethylene bottles to 25 ml measuring flasks (Maintain all the solutions at
25°C) Add 2 ml of buffer (to maintain pH)
Add 5 ml of working phenol solution, mix, fill to about 22 ml with distilled water
and then add 2.5 ml of working hypochlorite solution & mix rapidly
Store in the dark for 30 mins to develop colour. Measure the absorbance of the
solution at 630 nm using UV Spectrophotometer



Pipette 0.5, 1.0 and 1.5 ml of working standard solution (working ammonia solution)
in 25 ml measuring flasks
Fill to 10 ml mark with absorbing solution (0.1 M H₂SO₄). Add the reagents as to
each flask as in the procedure for analysis
Read the absorbance of each standard against the reagent blank.



Plot the calibration curve



Calculate the concentration of NH₃ in µg/m³

Guidelines for sampling and Analysis of Benzo(a)Pyrene & other PAHs in Ambient Air (Solvent Extraction & GC Analysis)

1. Purpose

The purpose of this protocol is to provide guidelines for monitoring of Benzo (a) Pyrene (BaP) in ambient air.

Benzo (a) Pyrene (BaP) is one of the most important constituent of PAH compounds and also one of the most potent carcinogens. This can be measured in both particulate phase and vapour phase. In the vapour phase the concentration of B(a)P is significantly less than the particulate phase. Therefore, more care to be taken for the measurement of Benzo (a) Pyrene in the particulate phase. The molecular formula of B(a)P is $C_{20}H_{12}$ having molecular weight 252 and structural formula is given in following figure:

Structural Formula of Benzo (a) Pyrene (BaP)

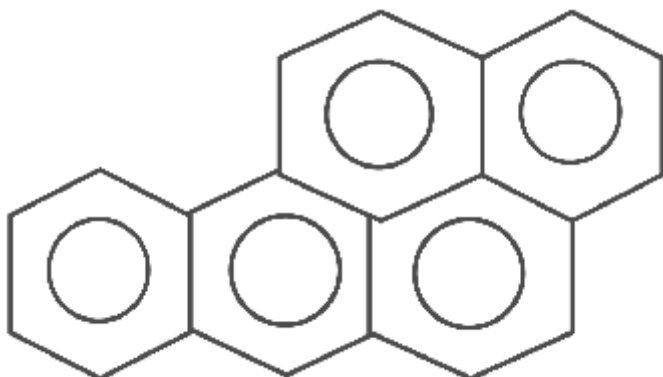

2. Standard

The national ambient air quality standard for Benzo(a)pyrene is presented in table

Pollutant	Time Weighted Average	Concentration in Ambient Air (ng/m ³)	
		Industrial, Residential, Rural and other Areas	Ecologically Sensitive Area (Notified by Central Government)
Benzo(a)pyrene	Annual	01	01

* Annual Arithmetic mean of minimum 104 measurements in a year at a particular site taken twice a week 24 hourly at uniform intervals.

** 24 hourly or 8 hourly or 1 hourly monitored values, as applicable, shall be complied with 98% of the time in a year. 2% of the time, they may exceed the limits but not on two consecutive days of monitoring.

3. Principle of the Method

It is based on BIS method IS 5182 (Part 12):2004 and USEPA method (TO-13). This method is designed to collect particulate phase PAHs in ambient air and fugitive emissions and to determine individual PAH compounds using capillary gas chromatograph equipped with flame ionization detector. It is a high volume ($1.2\text{m}^3/\text{min}$) sampling method capable of detecting $\text{sub.ng}/\text{m}^3$ concentration of PAH in 24 hours sample (i.e. collected in 3 shifts of 8 hour each with 480 m^3 sampling volume of air).

4. Equipment/Instruments

PM10 high volume sampler, Whatman Glass fibre (EPM-2000) or Equivalent Filter Paper, Ultra Sonicator ($\sim 40\text{kHz}$ frequency), Rotary Evaporator (Buchi type), Gas Chromatograph with Flame Ionization Detector fitted with Capillary Column (H.P. / Agilent Ultra 2 or equivalent, length 25 meter x 0.320mm , $0.17\mu\text{m}$ or more), Syringes (5 & 10 micro litre capacity), Variable volume micropipettes (0.5 & 1.0 ml capacity), Beakers (250 ml), Amber colour Vials 3ml and 5ml capacity, Chromatographic column ($200\text{-}250\text{ mm} \times 10\text{mm}$ with Teflon stopcock).

5. Chemical/Solvents

All chemicals, calibration /reference standards of B(a)P , other PAHs, Triphenyl benzene (internal standard, ultra residue grade) solvents like Toluene, Cyclohexane (with minimum residue less than 0.005%) etc.) & other chemicals like Silica -Gel (60-80 mesh size) should be of highest purity & of reputed make with traceability/purity and analysis certificate.

6. Sampling

6.1 Instrument/Filter Selection

24 hr. sampling using PM_{10} high volume sampler with 8 hourly samples using EPM-2000 glass fibre or equivalent filter.

6.2 Sampling Frequency

Sampling is done twice a week, total of 104 days monitoring in a year. Particulate laden Benzo(a)Pyrene samples are collected on glass fibre filter (EPM 2000 or equivalent) using PM_{10} sampler at a flow rate of more than $1\text{m}^3/\text{min}$ per minute, at selected location(s).

6.3 Sampling Height

Sampling height may be between 3-10 meters from the ground level for ambient air quality monitoring.

6.4 Sample Filter Storage

After sampling, filters are kept in the controlled laboratory conditions (20-25°C) in an envelope marked with necessary identification information if processed immediately, otherwise wrap the filters in Aluminium foil & kept it in refrigerator at 4°C in dark to avoid photo oxidation of PAHs.

6.5 Sample Processing

a. Extraction:

Filter papers (half of all the filters papers collected in a day) are cut into strips using scissors and transfer to 250 ml beaker. Add ~50 ml. of Toluene (GC/HPLC grade). These samples are extracted with toluene using ultra sonic bath for about 30 minutes. Repeat the procedure twice (50ml x 2 times) for complete extraction. Alternatively, sample can be extracted using soxhlet extraction apparatus for about 8 hr. with Toluene and repeat it twice. Sample processing steps are shown in Figure - 1.

b. Filtration:

Filter the extracted samples with Whatman filter paper no.41 containing 2 gm of Anhydrous Sodium Sulphate (to remove moisture).

c. Concentration:

After filtration, the filtrate is concentrated using Rotary vacuum evaporator (Figure-2) to 2ml final volume.

Figure - 1: Sample Processing

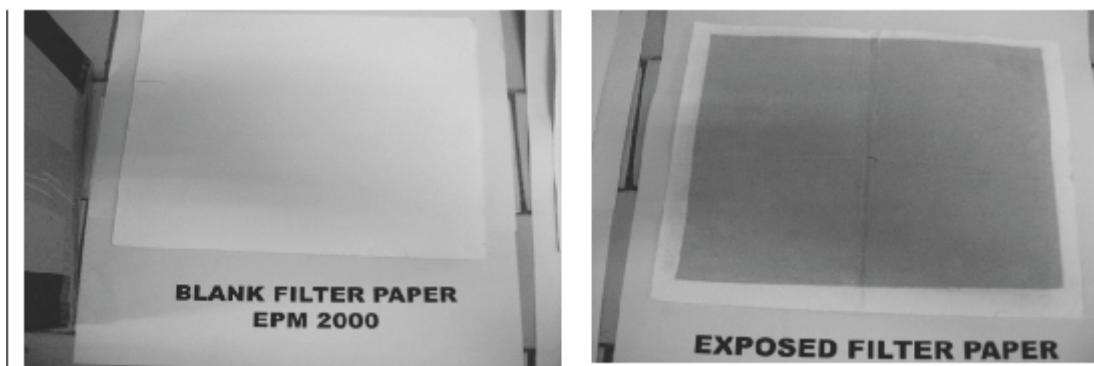

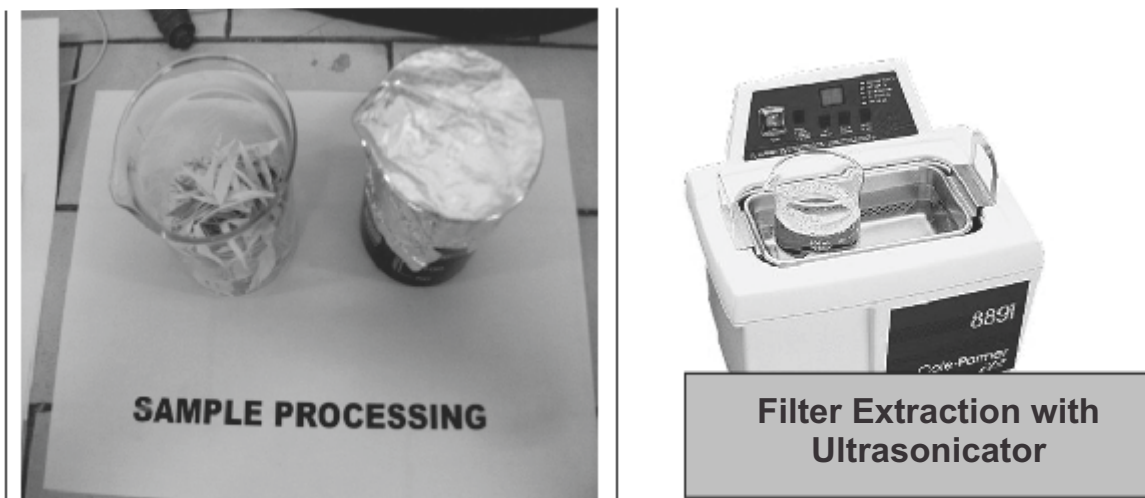
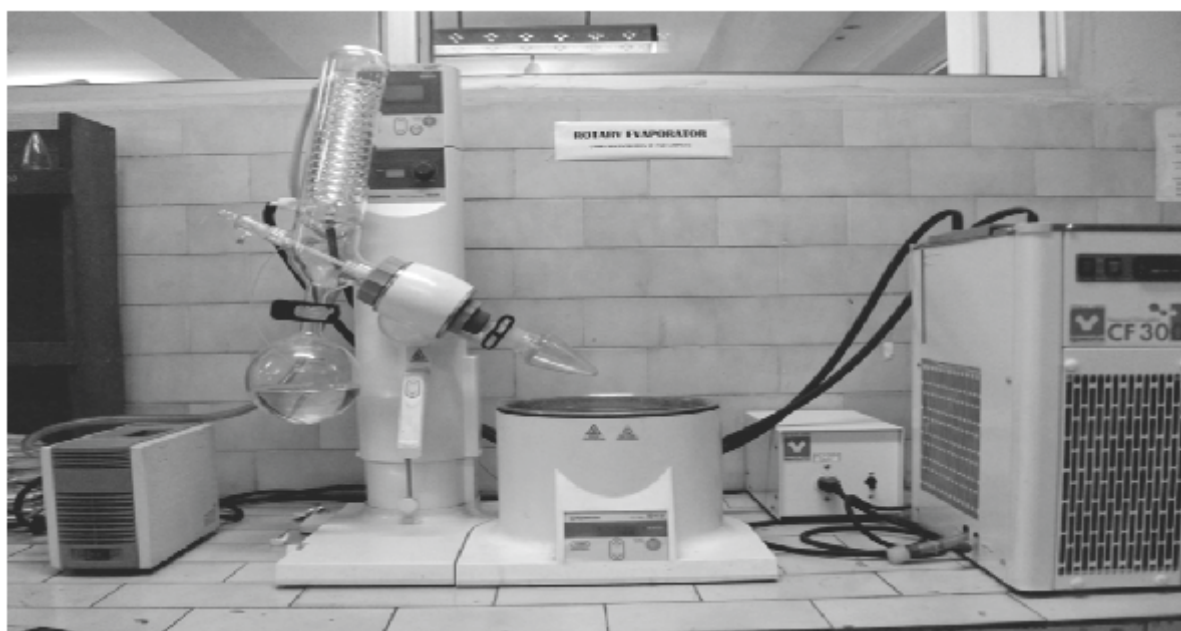

Figure - 2: Rotary Evaporator for Sample Concentration



- a. Clean-up with silica Gel:
 To clean up the impurities, pass 2 ml of concentrated sample through silica gel column (pre conditioned, 60-80 mesh, and 200-250mm×10 mm with Teflon stopcock). After cleaning add 5ml cyclohexane and collect the elute in 25 ml beaker. Repeat the process for at least 3 times and collect it in the same beaker. Alternatively Solid Phase Extraction (SPE) may be used for clean up the impurities of sample.
- b. Re-concentration with rotary vacuum evaporator:
 The Cleaned up extract/filtrate (approximately 17 ml) is further concentrated using rotary evaporator and it is evaporated to nearly dryness with Nitrogen.

f. Final Sample volume:

The dried sample is re-dissolved in 1ml of toluene and transfer into 4 or 5 ml amber vials final analysis.

g. Extracted Sample Storage:

Cover/ Cap the sample vials /tubes and mark with necessary identification. Keep it in refrigerator at 4°C prior to the analysis as in Figure -3

Figure -3: Ready to Inject B(a)P Samples

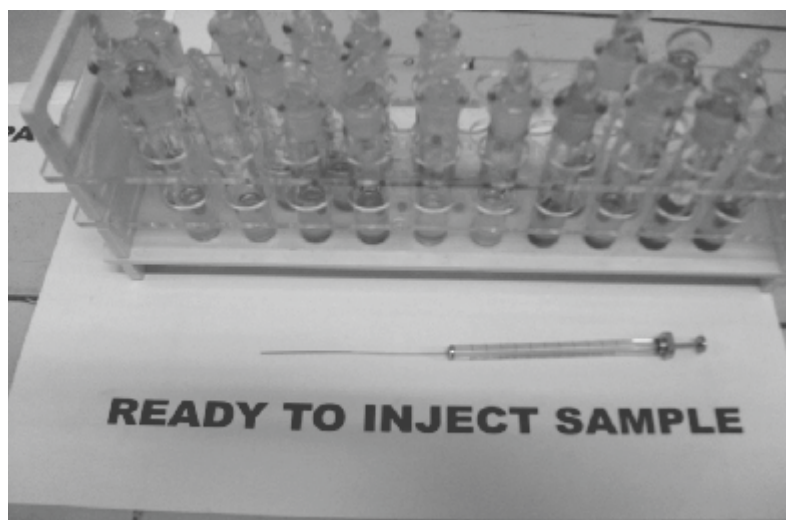

7. Analysis/Instrument Set-Up

GC Conditions:

Injector: 300°C

FID Temp: 320°C

Column: Ultra -2 (25m Length, 320µm diameter, 0.17µ) or equivalent

Oven: 120°C → 2 min hold → 7°C/min → 300°C → 10 min hold

Run Time: 37.71 minutes

Carrier gas flow (N₂): 0.50 ml/min

Gases for FID Flame:

H₂ flow: 40 ml/min

Zero grade air flow: 400 ml/min

7.1 Preparation of Standard Calibration Mixture

Stock Standard Solution PAH mix standard solution of 16 Compounds including B(a)P (Dr. Ehrenstorfer, Germany make PAH mix 63) of concentration 1000mg/l (or 1000ng/µl) in Toluene.

Working Standard Solution Working Standard Solutions (5, 10, 15, 20, 25 ng/ μ l concentrations) are prepared from stock solution by diluting 200 to 40 times the stock B(a)P or other PAH solution of 1000mg/l (or 1000ng/ μ l) concentration with Toluene.

Internal Standard 1, 2, 3-Tri Phenyl Benzene of concentration \sim 1000ng/ μ l is added in the working standard solution so that the final concentration of Internal standard is 10 ng/ μ l.

7.2 Calibration of GC

7.2.1 Internal Calibration

Inject 1 μ l of each Working Standard (5, 10, 15, 20, 25 ng/ μ l) in triplicate and plot the area ratio of analyte PAH Compound [i.e. B(a)P] and the corresponding internal standard against the concentration for each compound and internal standard. The instrument is calibrated as per its manual/software.

7.2.2 External Calibration

Inject 1 μ l of each Working Standard (5, 10, 15, 20, 25 ng/ μ l) made in Toluene into GC-FID and plot the area of analyte viz. PAH Compound [i.e.B(a)P] against the corresponding concentration of the standard. The instrument is calibrated as per its manual/software.

The quantification of that analyte will be based on peak area response of respective compounds with respect to working calibration standard, that is calibration factor (the ratio of response to the amount of mass injected).The retention time of various PAHs compounds are obtained under the above GC conditions.

7.2.3 Sample injection

Take 2 μ l of sample from the amber vial using standard gas tight syringe and inject in the Capillary GC-FID instrument for analysis. Record the resulting concentration of each PAH compound including B(a)P. A 10ng/ μ l concentration B(a)P or other PAH standards are to be injected in GC/FID instrument with every batch of samples. As a control Internal Standard of 10 ng/ μ l conc. is added to each sample prior to the analysis in case of internal calibration is used.

8. Calculations

Calculate the concentration in ng/ μ l of each identified analyte or B(a)P in the sample extract (Cs) as follows:

Calculate the air volume from the periodic flow reading taken during sampling using the following equation:

$$V = Q \times T$$

Where,

Q = Average flow rate of sampling m^3/min

T = sampling time, in min.

V = total sample volume at ambient conditions in m^3

Concentration of analyte i.e B(a)P:

The concentration of PAH compound or Benzo(a)pyrene in ng/m^3 in the air sampled is given by:

$$C (\text{ng}/\text{m}^3) = C_s * V_e / V_i * V_s$$

Where,

C_s : Concentration of Benzo (a) pyrene in $\text{ng}/\mu\text{l}$ in the sample extract recorded by GC.

V_e : Final volume of extract in μl (i.e 1000)

V_i : Injection Volume (i.e 1 μl)

V_s : Volume of air sample in m^3

9. Quality Control

For recovery efficiency isotopically labelled B(a)P or other PAH surrogate standards are added to the samples prior to extraction & analysis. The recoveries should fall between 75- 125 % preferably.

A 10 $\text{ng}/\mu\text{l}$ concentration B(a)P or other PAH standards are to be injected in GC/FID instrument with every batch of samples or daily as a control. If substantial variation is found in observed concentration, instrument should be recalibrated.

Internal Standard of 10 $\text{ng}/\mu\text{l}$ conc. is added to each sample prior to the analysis in case of internal calibration is used.

10. Detection Limit

The minimum detectable concentration in terms of B(a)P for a sampling period of 8hour (with about 480 m^3 of air passed) will be 1 ng/m^3 assuming 1.0 ml as the final volume of sample extract after clean-up and detectable concentration of 1 $\text{ng}/\mu\text{l}$ of that sample extract. High resolution capillary mass spectrometry or high pressure liquid chromatography can improve sensitivity down to 1 ng/m^3 .

11. References

BIS Method IS 5182 (Part 12):2004

USEPA Method TO-13,

FLOW CHART FOR MEASUREMENT OF BENZO(A)PYRENE

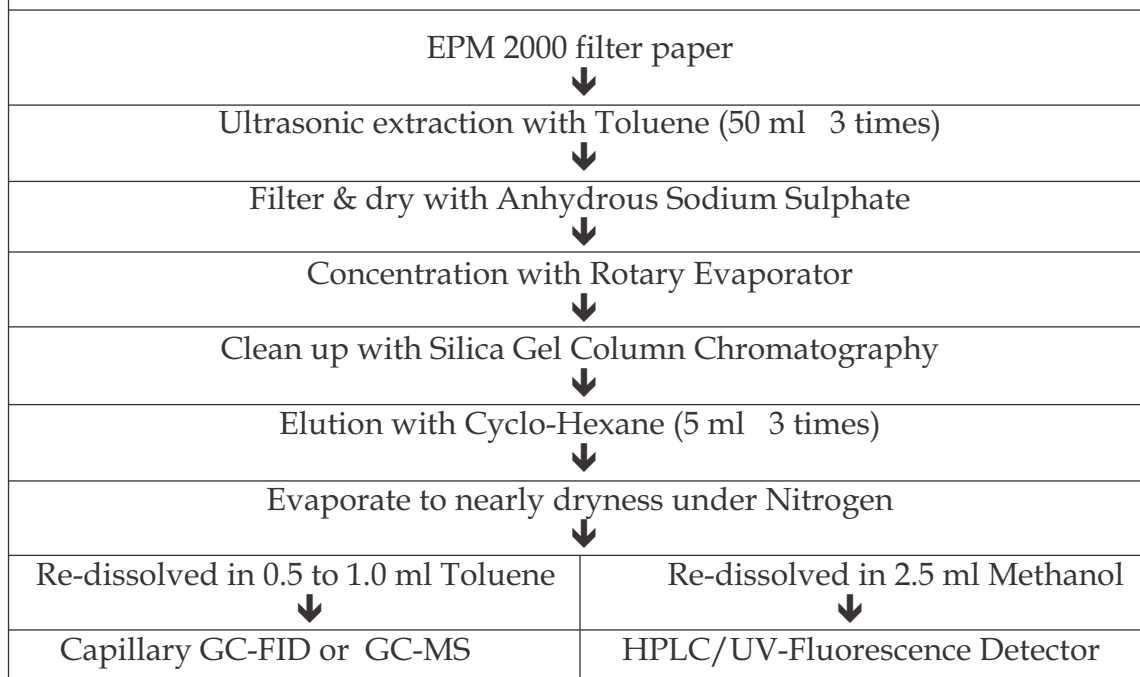

Guidelines for sampling and analysis of Lead, Nickel and Arsenic in ambient air (Atomic Absorption Spectrophotometer Method)

1. Purpose

The purpose of this protocol is to provide guidelines for monitoring of lead, nickel and arsenic in ambient air.

2. Standard

The national ambient air quality standards for lead, nickel and arsenic is presented in the table

Pollutant	Time Weighted Average	Concentration in Ambient Air	
		Industrial, Residential, Rural and other Areas	Ecologically Sensitive Area (Notified by Central Government)
Lead (Pb), $\mu\text{g}/\text{m}^3$	Annual * 24 Hours **	0.50 1.0	0.50 1.0
Nickel (Ni), ng/m^3	Annual *	20	20
Arsenic(As), ng/m^3	Annual *	06	06

* Annual Arithmetic mean of minimum 104 measurements in a year at a particular site taken twice a week 24 hourly at uniform intervals.

** 24 hourly or 8 hourly or 1 hourly monitored values, as applicable, shall be complied with 98% of the time in a year. 2% of the time, they may exceed the limits but not on two consecutive days of monitoring.

3. Principle of the method

The Atomic Absorption Spectroscopy (AAS) technique makes use of absorption spectrometry to assess the concentration of an analyte in the sample. The method is based on active sampling using PM_{10} High Volume Sampler and then sample analysis is done by atomic absorption spectrophotometer.

4. Instrument/Equipment

The following items are necessary to perform the protocol for monitoring of lead and nickel in ambient air:

- PM_{10} sampler (high volume design based)
- Hot plate

- Microwave Digestive System
- Analytical balance
- Digestion chamber
- Polyethylene or polypropylene bottle
- Glasswares
- Top loading orifice kit
- FAAS (Flame Atomic Absorption Spectrophotometer) or GFAAS (Graphite Furnace Atomic Absorption Spectrophotometer)

5. Reagents/Chemicals

- Filter Paper: EPM 2000 or equivalent, 20.3 X 25.4 cm (8 X 10 in)
- Hydrochloric Acid (HCl) Concentrated (AR grade)
- Nitric Acid (HNO₃) Concentrated (AR grade)
- Sulphuric Acid (H₂SO₄) Concentrated (AR grade)
- Metal Standard Solutions (Certified standard)
- Sodium borohydride (GR/ AR grade).
- Potassium iodide (GR/ AR grade)
- Distilled / De-ionized

6. Sampling

6.1 Sampling procedure

Tilt back the inlet and secure it according to manufacturer's instructions. Loosen the face-plate wing-nuts and remove the face plate. Remove the filter from its jacket and centre it on the support screen with the rough side of the filter facing upwards. Replace the face-plate and tighten the wing-nuts to secure the rubber gasket against the filter edge. Gently lower the inlet. For automatically flow-controlled units, record the designated flow rate on the data sheet. Record the reading of the elapsed time meter. The specified length of sampling is commonly 8 hours or 24 hours. During this period, several reading (hourly) of flow rate should be taken. After the required time of sampling, record the flow meter reading and take out the filter media from the sampler and put in a container or envelope.

6.2 Sample storage

After collecting samples, transport the filters to the laboratory, taking care to minimize contamination and loss of the sample. Glass fibre filters should be transported or shipped in a shipping envelope. Store these protective envelopes up to 30°C until analysis. The maximum sample holding times is usually 180 days. Analyze the samples within 180 days.

7. Analysis

7.1 Extraction of Samples

The collected sample on glass fibre filters may be extracted by either hot plate procedure or by microwave extraction (Method IO-3.1).

7.1.1 Microwave extraction

Cut 1"x 8" strip or half the filter from the 8"x10" filter sample and place on its edge in a labelled centrifuge tube using vinyl gloves or plastic forceps. Using the plastic forceps, crush the filter strip down into the lower portion of the centrifuge tube to ensure acid volume will cover entire filter. Add 10.0 ml of the extraction solution to each of the centrifuge tubes (3% conc. HNO₃ and 8% conc. HCl). Place the centrifuge tubes in a Teflon vessel containing 31 ml of deionized water. Place the vessel caps with the pressure release valves on the vessels hand-tight and tighten using the capping station to a constant torque of 12 ft-lb. Place the vessels in the microwave carousel. Connect each sample vessel to the overflow vessel using the Teflon connecting tubes. Place the carousel containing the 12 vessels on to the turntable of the microwave unit. Irradiate the sample vessels at 486 W (power output) for 23 min.

Allow the pressure to dissipate, then remove the carousel containing the vessels and cool in tap water for 10 min. using the capping station uncap the microwave vessels, remove the labelled centrifuge tube containing samples. Add 10ml of deionized water to each centrifuge tube. Cap the centrifuge tube tightly and mix the contents thoroughly for 2-3 minutes to complete extraction. The final extraction volume is 20ml based upon the above procedure. Filter the extracted fluid with Whatman No. 41 and make up the final volume to 100 ml, the filtered sample is now ready for analysis.

7.1.2 Hot plate procedure

Cut a 1" x 8" strip or half the filter from the 8" x 10" filter using a stainless steel pizza cutter. Place the filter in a beaker using vinyl gloves or plastic forceps. Cover the filter with the extraction solution (3% HNO₃ & 8% HCl). Place beaker on the hot-plate (Temperature below 80°C), contained in a fume hood, and reflux gently while covered with a watch glass for 30 min. Do not allow sample to dry. Remove the beakers from the hot-plate and allow to cool. Rinse the beaker walls and wash with distilled water. Add approximately 10 mL reagent water to the remaining filter material in the beaker and allow to stand for at least 30 min. Transfer the extraction fluid in the beaker to a 100 mL volumetric flask or other graduated vessel. Rinse the beaker and any remaining solid material with distilled water and add the rinses to the flask. Dilute to the mark with distilled water (Type I) water and shake. The final extraction solution concentration is 3% HNO₃/8% HCl. The filtered sample is now ready for analysis

7.2 Analysis of samples

7.2.1. Instrument/Equipment

A light beam containing the corresponding wavelength of the energy required to raise the atoms of the analyte from the ground state to the excited state is directed through the flame or furnace. This wavelength is observed by a monochromator and a detector that measure the amount of light absorbed by the element, hence the number of atoms in the ground state in the flame or furnace. A hollow cathode lamp for the element being determined provides a source of that metal's particular absorption wavelength.

The method describes both flame atomic absorption (FAA) spectroscopy and graphite furnace atomic absorption (GFAA) spectroscopy. Atomic Absorption Spectrophotometer - analyze the metals by Flame, if results are below detection limit then go for GTA. Arsenic is analyzed by Flame - VGA.

7.2.2. Flame Procedure

Set the atomic absorption spectrophotometer for the standard condition as follows: choose the correct hollow cathode lamp, align the instrument, position the monochromator at the value recommended by the manufacturer, select the proper monochromator slit width, set the light source current, ignite the flame, regulate the flow of fuel and oxidant, adjust the burner for maximum absorption and stability and balance the meter. Run a series of standards of the metal of interest and construct a calibration curve. Aspirate the blanks and samples. Dilute samples that exceed the calibration range. For Lead (Pb) and Nickel (Ni), the wavelength required for analysis is 217nm and 232nm respectively. Where as in case of Arsenic (As), the VGA should attach with Flame and the wavelength required for analysis is 193.7nm.

7.2.3. Furnace Procedure

As a general rule, samples that can be analyzed by flame or furnace may be more conveniently run with flame since flame atomic absorption is faster, simpler and has fewer interference problems. Tube life depends on sample matrix and atomization temperature. A conservative estimate of tube life is about 50 firings. Read the metal value in $\mu\text{g/L}$ from the calibration curve or directly from the read-out of the instrument.

8. Calibration

Prepare standard solutions from the stock solutions. Select at least three standards to cover linear range as recommended by method. Aspirate the standards into the flame or inject the standards into the furnace and record the absorbance. Prepare the calibration graph by plotting absorbance and concentration in $\mu\text{g/ml}$.

8.1. Preparation of Standards

For each metal that is to be determined, standards of known concentration must be acquired commercially certified standards.

8.2. Standard Curve

Standard curve is prepared by using standard solutions of known concentration.

9. Quality Control

To produce good quality data, perform quality control checks and independent audits of the measurement process; document their data and use materials, instruments and measurement procedures that can be traced to an appropriate standard of reference. Shewart's analytical quality control chart should be maintained for good quality data. Detection limit and working range for each metal should be followed of the working instrument.

9.1 Precision

Analyze the pretreated sub-samples. Calculate the standard deviation (S) and coefficient of variation (CV) where $CV = S.100/\text{mean value}$. If the CV is greater than 10%, check the whole procedure for possible errors and/or contamination. The precision of the method is normally better than + 5% at the 95% confidence level.

9.2 Accuracy

Analyze the pretreated Certified Reference Material (CRM) or internal reference material. Calculate the mean and the standard deviation. If the value given for the CRM is within the interval of mean + standard deviation, the method has the required accuracy. If not, check the whole procedure.

10. Calculations

10.1 Sample Air Volume

Sample air volume can be calculated by using the following equation:

$$V = (Q) (t)$$

Where,

V	=	volume of air, m ³
Q	=	average sampling rate, m ³ /min.
t	=	time in minutes.

10.2 Metal Concentration

$$C = (M_s - M_b) \times V_s \times F_a / V \times F_t$$

Where,

- C = concentration, $\mu\text{g metal}/\text{m}^3$.
M_s = metal concentration $\mu\text{g}/\text{mL}$
M_b = blank concentration $\mu\text{g}/\text{mL}$
V_s = total volume of extraction in mL
F_a = total area of exposed filter in cm^2
V = Volume of air sampled in m^3
F_t = Area of filter taken for digestion in cm^2

11. References

- Method IO-2.1 Sampling of Ambient Air for Total Suspended Particulate Matter (SPM) and PM₁₀ Using High Volume (HV) Sampler
- Method 501, Air Sampling and Analysis, 3rd Edition, Lewis publishers Inc.
- IS 5182 Part 23 Method of Measurement of Air Pollution :Respirable Suspended Particulate Matter (PM₁₀) cyclonic flow technique
- EPA compendium method IO 3
- EPA compendium method IO 3.1
- EPA compendium method IO 3.2
- Standard Method-American Public Health Association (APHA), 20th Edition, 1998.

FLOW CHART FOR SAMPLE PROCESSING OF LEAD, NICKEL AND ARSENIC IN AMBIENT AIR

Collect the particulate matter on glass fibre filter (EPM 2000 or equivalent) using PM₁₀ sampler (High Volume Sampling).



Divide the filter paper in two equal parts



Half portion of filter paper for the measurement of lead, nickel and arsenic



Extract the sample by either hot plate procedure or by microwave extraction



Analysis of extracted sample using recommended method

FLOW CHART FOR MEASUREMENT OF LEAD AND NICKEL BY FLAME-
ATOMIC ABSORPTION SPECTROPHOTOMETER:

Method I (Method IO-3 ,IO-3.2)

Switch on Atomic Absorption Spectrophotometer



Select and set the Hollow Cathode Lamp of desired metal and programming the instrument accordingly



Adjust and align the instrument as per requirement



Switch on Compressor for Air and Open the required gas cylinders (Air - Acetylene for Flame analysis), Ignite the Flame

Calibration with metal standards as recommended in method



Prepare calibration graph



Analyze the digested samples



Calculate the concentration using calibration graph

FLOW CHART FOR MEASUREMENT OF LEAD, NICKEL AND ARSENIC BY
GRAPHITE TUBE-ATOMIC ABSORPTION SPECTROPHOTOMETER:

Method II (Method IO-3,IO-3.2)

Switch on Atomic Absorption Spectrophotometer



Place the furnace, adjust and align the instrument as per requirement of GTA.



Select and set the Hollow Cathode Lamp of desired metal and programming the instrument accordingly for standards and samples



Switch on Chiller and keep the Temperature at 200 C. Open the Nitrogen gas



Clean the Graphite Tube with a firing



Click the START Button



Calibration with metal standards as recommended in method



Prepare calibration graph



Analyze the digested samples



Calculate the concentration using calibration graph



Note: Always follow the instructions of the Instrument/ Operational manual given by the supplier

FLOW CHART FOR MEASUREMENT OF ARSENIC BY FLAME- ATOMIC
ABSORPTION SPECTROPHOTOMETER USING VAPOUR GENERATION

ASSEMBLY (VGA):

Method III

(Standard Method- American Public Health Association (APHA), 20th Edition,
1998.)

Switch on Atomic Absorption Spectrophotometer



Select and set the Hollow Cathode Lamp of Arsenic and programming the
instrument accordingly



Adjust and align the instrument as per requirement -VGA



Switch on Compressor for Air and Open the required gas cylinders (Air - Acetylene
for Flame analysis and Nitrogen for Hydride Generator)



Ignite the Flame



Check the flow rate of Hydride Generator



Calibration with Arsenic standards as recommended in method



Prepare calibration graph



Analyze the digested samples



Calculate the concentration using calibration graph

Note: Always follow the instructions of the Instrument / Operational manual
given by the supplier

DISCLAIMER

The guidelines for the measurement of Ambient Air Pollutants (NAAQS 2009) are based on the reference methods (Viz. Indian Standards, United States Environment Protection Agency and Inter Society Committee) based on field and laboratory experiences.

Efforts have been made to make it user friendly and easily understandable, however comments and suggestions towards its improvement are solicited.

© Central Pollution Control Board, 2011

CENTRAL POLLUTION CONTROL BOARD
FIELD DATA SHEET FOR GASEOUS POLLUTANTS

Station:						
Shift	Date:		Graph Factor		NO ₂	
	1st Shift		IIInd Shift		IIIrd Shift	
Monitoring Period	06:00AM-10:00AM	10:00AM-02:00 PM	02:00PM-06:00PM	06:00PM-10:00PM	10:00PM-02:00AM	02:00AM-06:00AM
Parameter	SO ₂	NO ₂	SO ₂	NO ₂	SO ₂	NO ₂
Hourly Flow Rate (lpm)						
Average Flow Rate (lpm)						
Total Operation Time (Minutes)						
Initial Volume of Sample (ml)						
Final Volume of Sample (ml)						
Volume Taken For Analysis (ml)						
Total Volume of Air Sampled (lit.)						
Absorbance (Blank)						
Absorbance (Sample)						
Concentration (µg/m ³)						
24 Hourly Average SO ₂ (µg/m ³):						24 Hourly Average NO ₂ (µg/m ³):
Remarks:						
Name & Signature of Official on duty						
Analyzed by:						

CENTRAL POLLUTION CONTROL BOARD

RESULTS DATA SHEET FOR GASEOUS POLLUTANTS & PM₁₀

Location: _____ Month: _____ Year: _____

TIME (Hrs.) PARAMETER /DATE	06-10		10-14		14-18		18-22		22-02		02-06		4 HRS. MAX		24 HRS.AVG		8 HRS. AVG PM ₁₀		24 HRS. AVG			
	SO ₂	NO ₂	SO ₂	NO ₂	SO ₂	NO ₂	SO ₂	NO ₂	SO ₂	NO ₂	SO ₂	NO ₂	SO ₂	NO ₂	SO ₂	NO ₂	06-14	14-22	22-06	PM ₁₀		

Note: All values are expressed in μg/m³

Weather Condition: Clear/Cloudy/Rainy

Name & Signature of Official on Duty: _____

Checked by: _____

CENTRAL POLLUTION CONTROL BOARD

DATA SHEET FOR PARTICULATE MATTER (Size less than 10 μm) or PM₁₀

Station:	Date:		
Shift			
Monitoring Duration			
Filter Paper No.			
Hourly Flow Rate (m³/minute)			
Average Flow Rate (m³/minute)			
Total Operation Time (Minutes)			
Initial Weight of Filter Paper (gms.)			
Final Weight of Filter Paper (gms.)			
Dust Contents (gms.)			
Total Volume of Air Sampled (m³)			
Concentration ($\mu\text{g}/\text{m}^3$)			
24 Hourly Average SPM ($\mu\text{g}/\text{m}^3$):			
Remarks:			
Name & Signature of Official on Duty:			
Analyzed by:			

SAMPLE TRACKING SHEET (PM_{2.5})

Filter Paper Nos.						Sender's or Operator's Signature	Received by (Signature)	
F.Paper Type								
Lot/Batch No.								
Site Description								
Date of Sampling								
Inspection	Date of inspection	Inspection done by	Certified by					
Lab Code								
Pre-conditioning	Nature	Date and Time	Done by	Certified by				
Pre-weighing	Date and Time	Weighed by	Balance Calibration (Y/N)	Control weight Status				
Dispatch detail	Date	To (Specify Sites)						
Filter Receiving	Date & Time	Sites	Sampling date & time	Condition of filters				
Post Conditioning	Nature	Date and Time	Done by	Certified by				
Post-weighing	Date & Time	Weighed by	Balance Calibration (Y/N)	Control weight Status				
Dispatch Detail	Date & time	To (Specify Lab)	Parameters	Results Expected by the date				

CENTRAL POLLUTION CONTROL BOARD

PM_{2.5} ANALYSIS REPORT

Name of the Project :
Name of Executing Agency :
Sampling Location ID and Name :
Monitoring Season :
Date and Time of Monitoring :
ID of Instrument used :
Last date of Calibration :
Field Sampling Done by :
Analysis Done By :
Filter ID :

Start time	Closing time	Initial Weight (mg)	Final weight (mg)	Flow rate (LPM)	Air Volume (m ³)

Calculation:

Volume of air passed (V) = Sampling Duration (Min) X LPM (Average)
Dust collected on Filter (M) = (Final weight – Initial weight) * 1000 µg
Concentration = M / V µg/m³

Remarks:

Meteorological conditions: Temperature – (Min & Max)
% RH – (Min & Max)
Rain fall –

Sampling Stoppage time (if any) with reason:

Name & Signature of Field Operator

Name & Signature of Analyst

Report Checked by (Supervisor)

Report Approved by
(Officer in charge)

DATA SHEET FOR OZONE IN AMBIENT AIR

Monitoring Duration	Average Flow Rate (lpm)	Total Sampling Time (Minutes)	Total Volume of Air Sampled (lit.)	Volume of Sample (ml)	Absorbance (Blank)	Absorbance (Sample)	Conc. ($\mu\text{g}/\text{m}^3$)
0600-0700							
0700-0800							
0800-0900							
0900-1000							
1000-1100							
1100-1200							
1200-1300							
1300-1400							
1400-1500							
1500-1600							
1600-1700							
1700-1800							
1800-1900							
1900-2000							
2000-2100							
2100-2200							
2200-2300							
2300-2400							
2400-0100							
0100-0200							
0200-0300							
0300-0400							
0400-0500							
0500-0600							

CENTRAL POLLUTION CONTROL BOARD

Data Sheet for Ozone

Month:

Station:

Duration Date ↓	06- 07	07- 08	08- 09	09- 10	10- 11	11- 12	12- 13	13- 14	14- 15	15- 16	16- 17	17- 18	18- 19	19- 20	20- 21	21- 22	22- 23	23- 24	24- 01	01- 02	02- 03	03- 04	04- 05	05- 06

Concentrations in $\mu\text{g}/\text{m}^3$

**CENTRAL POLLUTION CONTROL BOARD
AIR LAB DIVISION**

FIELD DATA SHEET (BaP/PAH MONITORING)

Monitoring Location Details:

Sheet No.-----

Date & time of start	Date & time of close	Run Time in Minutes
Instrument Make & S.No	Average Flow Rate	Total Air Volume
Filter Paper No	Final Weight (gm)	Initial Weight (gm)
Net Weight (gm)	PM10 Conc. (ug/m ³)	Special Weather Note (Rainy/cloudy/Sunny/ Windy/stormy Day)
PI fill which ever Shift applicable		

Monitoring team members (Names with Signatures & Dates):

Time	Mano- meter Reading m ³ /min	Timer Reading	Time	Mano- meter Reading m ³ /min	Timer Reading	Time	Mano- meter Reading m ³ /min	Timer Reading
6.00			14.00			22.00		
7.00			15.00			23.00		
8.00			16.00			24.00		
9.00			17.00			01.00		
10.00			18.00			02.00		
11.00			19.00			03.00		
12.00			20.00			04.00		
13.00			21.00			05.00		
14.00			22.00			06.00		
Avg. Flow m3/min			Avg. Flow m3/min			Avg. Flow m3/min		

1. _____ 2. _____ 3. _____

Project Coordinator (Name with Signature): _____

**CENTRAL POLLUTION CONTROL BOARD
AIR LAB DIVISION
BaP/PAH ANALYSIS REPORT**

Report S. No. _____

Date: _____

S.No.	Sampling Location	Sample details	Date of Sampling	Time of sampling	Benzo(a)Pyrene (ng/m ³)	TPAH (ng/m ³) (if analysed)
1.						
2.						
3.						
4.						
5.						
6.						

Note: Sample analyzed using Capillary GC-FID.

(Analyst)

(Supervisor)

(I/C –Laboratory)

CENTRAL POLLUTION CONTROL BOARD

DATA SHEET FOR PARTICULATE MATTER (Size less than 10 μm) or PM_{10}

Station:	Date:		
Shift			
Monitoring Duration			
Filter Paper No.			
Hourly Flow Rate (m^3/minute)			
Average Flow Rate (m^3/minute)			
Total Operation Time (Minutes)			
Initial Weight of Filter Paper (gms.)			
Final Weight of Filter Paper (gms.)			
Dust Contents (gms.)			
Total Volume of Air Sampled (m^3)			
Concentration ($\mu\text{g}/\text{m}^3$)			
24 Hourly Average SPM ($\mu\text{g}/\text{m}^3$):			
Remarks:			
Name & Signature of Official on Duty:			
Analysed by:			

CENTRAL POLLUTION CONTROL BOARD

Parivesh Bhawan, East Arjun Nagar, Delhi-110 032

Trace Metals Analysis Report

1. Report no. & issue date :
2. Name of the Project :
3. Sample matrix :
4. Date & time of sample collection :
5. Samples collected by :
6. Date & time of sample receipt :
7. Date of sample analysis :
8. Sample registration no. & date :
9. Sampling plan reference :
10. Test method reference :
11. Report sent to (Name & Address) :

S. No.	Sample Code	Pb ($\mu\text{g/ml}$)	Ni ($\mu\text{g/ml}$)	As ($\mu\text{g/ml}$)

Statement:

1. The results relate only to the samples tested.
2. The report shall not be reproduced except in full, without the written approval of the laboratory.

Analyst

Supervisor

In-Charge

CENTRAL POLLUTION CONTROL BOARD
Parivesh Bhawan, East Arjun Nagar, Delhi -110 032

Analysis report of Metals

Month:

Station:

Date	24 hour average concentration		
	Lead ($\mu\text{g}/\text{m}^3$)	Nickel (ng/m^3)	Arsenic (ng/m^3)

Analyst

Supervisor

Incharge

Ambient Air Quality Data Reporting Format (Annual)

Monitoring Agency :
 Year :
 Name of City :
 Name of Station : Station Code :
 Area :

Parameters	Unit	No. of 24 Hourly observations	Annual Mean	Measurement Method #
Sulphur dioxide (SO ₂)	µg/m ³			Improved West and Gaeke Method
				Ultraviolet Fluorescence
				Any Other
Nitrogen dioxide (NO ₂)	µg/m ³			Jacob & Hochheiser modified (NaOH-NaAsO ₂) Method
				Gas Phase Chemiluminescence
				Any Other
Ammonia (NH ₃)	µg/m ³			Chemiluminescence
				Indophenol method
				Any Other
Particulate Matter, PM ₁₀	µg/m ³			Gravimetric
				Beta attenuation
				TEOM
				Any Other
Particulate Matter, PM _{2.5}	µg/m ³			Gravimetric
				Beta attenuation
				TEOM
				Any Other
Lead (Pb)	µg/m ³			AAS/ICP Method after sampling on EPM 2000 or equivalent filter paper
				ED-XRF using Teflon filter
				Any Other
Nickel (Ni)	ng/m ³			AAS/ICP Method after sampling on EPM 2000 or equivalent filter paper
				Any Other
Arsenic (As)	ng/m ³			AAS/ICP Method after sampling on EPM 2000 or equivalent filter paper
				Any Other
Benzo (a) Pyrene (BaP)	ng/m ³			Solvent extraction followed by HPLC/GC analysis
				Any Other
Benzene (C ₆ H ₆)	µg/m ³			Gas Chromatography (GC) based continuous analyzer
				Adsorption and desorption followed by GC analysis
				Any Other

Tick (✓) mark the method followed

(Checked & Compiled by)

(Authorized Signatory)

Ambient Air Quality Data Reporting Format (24 Hours)

Monitoring Agency :
 Month & Year :
 Name of City :
 Name of Station : Station Code :
 Area :

Date↓	Concentration					
	SO ₂ (µg/m ³)	NO ₂ (µg/m ³)	PM ₁₀ (µg/m ³)	PM _{2.5} (µg/m ³)	NH ₃ (µg/m ³)	Benzene (µg/m ³)
Measurement Method # →	Improved West and Gaeke Method	Jacob & Hochheiser modified (NaOH-NaAsO ₂) Method	Gravimetric	Gravimetric	Chemiluminescence	Gas Chromatography (GC) based continuous analyzer
			Beta attenuation	Beta attenuation		
	Ultraviolet Fluorescence	Gas Phase Chemiluminescence	TEOM	TEOM	Indophenol method	Adsorption and desorption followed by GC analysis
	Any Other	Any Other	Any Other	Any Other	Any Other	Any Other

Tick (✓) mark the method followed
 Note: 24 hourly Data of Benzene required for calculation of Annual average

(Checked & Compiled by) (Authorized Signatory)
N

Ambient Air Quality Data Reporting Format (01 Hour/08Hours)

Monitoring Agency :
 Month & Year :
 Name of City :
 Name of Station : Station Code :
 Area :

	CO (mg/m ³)	CO (mg/m ³)	Ozone (µg/m ³)	Ozone (µg/m ³)
Measurement Method # →	Non dispersive Infrared (NDIR) Spectroscopy		UV Photometric	
			Chemiluminescence	
	Any Other		Chemical Method	
			Any Other	
Hours	01 Hour	08 Hours	01 Hour	08 Hours

Tick (✓) mark the method followed

(Checked & Compiled by)

(Authorized Signatory)

Ambient Air Quality Data Reporting Format (24 Hours)

Monitoring Agency :
 Month & Year :
 Name of City :
 Name of Station : Station Code :
 Area :

Date ↓	Concentration in PM ₁₀			
	Lead (Pb) (µg/m ³)	Nickel (Ni) (ng/m ³)	Arsenic (As) (ng/m ³)	BaP (ng/m ³)
Measurement Method # →	AAS/ICP Method after sampling on EPM 2000 or equivalent filter paper	AAS/ICP Method after sampling on EPM 2000 or equivalent filter paper	AAS/ICP Method after sampling on EPM 2000 or equivalent filter paper	Solvent extraction followed by HPLC/GC analysis
	Any Other	Any Other	Any Other	Any Other

Note: 24 hourly Data of Nickel, Arsenic & BaP required for calculation of Annual average

(Checked & Compiled by)

(Authorized Signatory)



PARIVESH BHAWAN, CPCB HEAD OFFICE

Central Pollution Control Board
'Parivesh Bhawan', East Arjun Nagar,
Shahdara, Delhi -110 032
Tel. 011-43102030
Telefax- 22305793/22307078/22301932/22304948
e-mail : cpcb@nic.in Web: cpcb.nic.in

Zonal Offices of Central Pollution Control Board

BANGALORE
 1st and 2nd Floors, Nisarga Bhavan,
 A-Block, Thimmai Main Road, 7th D Cross,
 Shivanagar, Opp. Pushpanjali Theatre,
 Bangalore - 560 010
 Tel. 080-23233827 (O) 080-23233739/
 23233827/23233996 Fax- 080-23234059

BHOPAL
 3rd Floor, Shakar Bhawan,
 North TT Nagar,
 Bhopal - 462 003
 Tel. 0755-2775587 (O)
 2775385/86 (EPABX)
 Fax - 0755-2775587

KOLKATA
 Southernd Conclave
 Block 502, 5th & 6th Floors,
 582 Rajdanga, Main Road,
 Kolkata - 700 107
 Tel. 033-24416332 (Direct)24414289/
 4677/6003/6634 Fax - 033-24418725

LUCKNOW
 Ground Floor, PICUP Bhawan,
 Vibhuti Khand, Gomti Nagar,
 Lucknow - 226 010
 Tel. 0522-4087601/2721915/16
 0522-4087600 (EPABX)
 Fax 0522-2721891

SHILLONG
 TUM-SIR Lower Motinagar,
 Near Fire Brigade H.Q.
 Shillong - 793 014
 Tel. 0364-2520923/2522859
 Fax 0364-2520805

VADODARA
 Parivesh Bhawan
 Opp. VMC Ward Office No. 10,
 Subhanpura, Vadodara - 390 023
 Tel. 0265-2283226/ 2283245
 Fax 0265-2283294

AGRA PROJECT OFFICE
 4, Dholpur House,
 M.G. Road,
 Agra - 282 001
 Tel. 0562-2421548
 Fax 0562-2421568

A Clean PARIVESH for all is our goal