

ALTERNATIVE TREATMENT TECHNOLOGIES FOR WASTEWATER TREATMENT IN DRAINS

**In Compliance to Direction of Hon'ble NGT in the Matter of OA No. 06/2012
Titled Manoj Mishra Vs Union of India & ORS**



February, 2020

CENTRAL POLLUTION CONTROL BOARD, DELHI

CONTENTS

LIST OF ABBREVIATIONS	3
1. BACKGROUND	4
2. ADVANTAGES AND ECOLOGICAL SERVICES OF ALTERNATIVE BIOLOGICAL TREATMENT TECHNOLOGY	4
3. WATERSHED PATTERN – STREAM ORDER	5
4. ALTERNATIVE TREATMENT TECHNOLOGIES	7
4.1 IN-SITU BIOREMEDIATION TECHNIQUES	7
4.1.1 Phytoremediation	7
4.1.2 Constructed Wetlands (CWs)	7
4.1.3 Microbial Bioremediation	9
4.2 Ex-Situ Remediation Techniques	10
4.2.1 Waste stabilization pond	10
4.2.2 Mechanically Aerated Lagoon	11
5. CRITERIA FOR SELECTION OF ALTERNATIVE TREATMENT TECHNOLOGIES FOR REJUVENATION OF DRAINS	13
6. SCHEMES/MODELS FOR DIFFERENT ORDERS OF DRAIN	14
6.1 Model 1: Minor sewage drain with moderate pollution load & broader channel	14
6.2 Model 2: Minor sewage drain with moderate pollution load & wide channel	15
6.3 Model 3: Minor sewage drain with moderate pollution load & narrow channel	16
6.4 Model 4: Minor sewage drain with high pollution load & broader channel	17
6.5 Model 5: Minor sewage drain with high pollution load & wide channel	18
6.6 Model 6: Minor sewage drain with high pollution load & narrow channel	19
6.7 Model 7: Medium sewage drain with low pollution load & broader channel	20
6.8 Model 8: Medium sewage drain with low pollution load & wide channel	21
6.9 Model 9: Medium sewage drain with moderate pollution load & broader channel	22
6.10 Model 10: Medium sewage drain with moderate pollution load & wide channel	23
6.11 Model 11: Medium sewage drain with high pollution load & broader channel	24
6.12 Model 12: Medium sewage drain with very high pollution load & broader channel	25
6.13 Model 13: Major sewage drain with low high pollution load & broader channel	26
6.14 Model 14: Major sewage drain with moderate pollution load & broader channel	27
6.15 Model 15: Major sewage drain with low pollution load & broader channel	28
7. CHALLENGES WITH APPLICATION OF ALTERNATIVE BIOLOGICAL TREATMENT TECHNOLOGY	33

8. CASE STUDIES ON DIFFERENT ALTERNATIVE TREATMENT TECHNOLOGIES	33
9.0 AN EXAMPLE OF PROPOSED TREATMENT SCHEME	35
9. ACKNOWLEDGEMENT	37
ANNEXURE-I	38

LIST OF ABBREVIATIONS

BOD- Biological oxygen demand
COD – Chemical oxygen Demand
CPCB – Central Pollution Control Board
CW- Constructed wetland
DO – Dissolved oxygen
EL – Elevation
EM – Electromagnetic
ICT- Institute of Chemical Technology
IIT- Indian Institute of Technology
MLD- Million liter per day
MSL- Mean sea level
N – Nitrogen
NEERI- National Environmental Engineering Research Institute
NGT – National Green Tribunal
NH₃-N – Ammonical Nitrogen
NO₃-N – Nitrate Nitrogen
O&M - Operation & Maintenance
OL- Organic load
OLR – Organic loading rate
P- Phosphorus
PO₄-P – Phosphate
STP – Sewage Treatment plants
TERI- The Energy and Resources Institute
TSS – Total dissolved solids
V – Volume
WSP- Waste stabilization pond

**REPORT ON ALTERNATIVE TREATMENT TECHNOLOGIES FOR
WASTEWATER TREATMENT OF DRAINS IN COMPLIANCE TO DIRECTION OF
HON'BLE NGT IN THE MATTER OF OA NO. 06/2012 TITLED MANOJ MISHRA VS
UNION OF INDIA & ORS.**

1. BACKGROUND

The verbatim of Hon'ble National Green Tribunal in the matter of OA No. 06 of 2012 titled; Manoj Mishra Vs Union of India & Ors. vide order dated 22.01.2020 at para 25 is as follows:

“Since the above report does not mention the generic and representative models which could be customised, adapted and adopted to the natural scenario including the drains in question, let CPCB furnish such a report containing at least ten generic and representative models which are techno-economically feasible and can be implemented after customization to the YMC by 07.02.2020 and the YMC may include the report with its comments in its report to be submitted to this Tribunal before the next date by e-mail at judicial-ngt@gov.in.

CPCB furnish a report in terms of Para 25 above to the YMC by 07.02.2020 and the YMC may include the report with its comments in its report to be submitted to this Tribunal before the next date by e-mail at judicial-ngt@gov.in.”

A meeting was convened on 27.01.2020 to consult experts including representatives from NEERI, TERI, Delhi University and other stakeholders. During the meeting, apart from in-situ remediation, low cost decentralised treatment systems (waste stabilization pond, oxidation pond, anaerobic lagoon) were also discussed, which can be adopted as ex-situ treatment. Another meeting was convened on 29.01.2020 wherein consultation was held with experts from IIT-Roorkee, IIT-BHU and ICT - Mumbai.

2. ADVANTAGES AND ECOLOGICAL SERVICES OF ALTERNATIVE BIOLOGICAL TREATMENT TECHNOLOGY

In situ treatment methods such as constructed wetland system, phytoremediation, Eco Bio Block system, microbial bio remediation are most favorable methods for alternative biological treatment technology of drains. Although above treatment systems are temporary provision but it may be adopted for further polishing of STP effluent. Alternative biological treatment technologies are not only useful in improving water quality of drains / rivers but are also helpful in rejuvenation of the ecology of a river system. Benefits of alternative biological treatment technologies are highlighted below:

- Alternative biological treatment technology methods such as phytoremediation or wetland systems are efficient in terms of nutrient removal such as removal of nitrogen and phosphorous.

- All alternative biological treatment technologies are low in energy incentive and not only reduces carbon footprint thereby minimizing climate change impact but also contributes to carbon sequestration.
- Constructed Wetlands have highest microbial diversity that will biodegrade not only organic but all emergent pollutants including odor producing substances & gases, antibiotic, detergent, pharmaceutical products, etc.
- The technologies provide benefits like increase in the biodiversity and biomass production apart from habitat conservation.
- Constructed Wetlands may attract migratory birds, as well as provide aesthetic and recreational services to the public.
- Studies indicate that there is massive reduction in pathogenic microbes in alternative biological treatment technology as compared to conventional treatment.
- In-situ remediation technique does not require much energy, its maintenance cost is relatively low, it is easy to develop, operate and manage as compared to conventional technology. Besides high reduction efficiency of BOD, different alternative treatment technologies are efficient in increasing Dissolve Oxygen (DO) and reducing Fecal Coliform (FC) e.g. Phytoremediation technique can reduce FC by 50% and increase DO from 0 to 5 mg/l; Oxidation Pond can reduce FC by more than 95% and increase DO from 0 to 5mg/l; similarly, lagoons are efficient in reduction of FC by 50-70%.
- The cost of alternative biological treatment technology is extremely low.
- In-situ remediation is more efficient in restoring self-purification system of river and also immobilization of heavy metals.
- Constructed wetlands contribute to groundwater recharge as well as results in buffering of ambient temperature and odor.

3. WATERSHED PATTERN – STREAM ORDER

Based on the drainage pattern, all drains traverse towards recipient water body located downstream of drains. Drains which directly discharge into recipient water bodies such as rivers, rivulets, ponds, lakes etc. are called as first order drain. Drains which join into first order drain are called as second order drains. Similarly, third and fourth order drains could be defined. The first and second order drains which confluence directly with River system are relatively larger with continuous flow.

Generally, drain emerging from urban centers/ rural habitats are third or fourth order drains which confluence into larger second or first order drains finally meeting into river/ pond/lakes.

Third and fourth order drains are rather narrow, very shallow, located at higher gradient, usually shorter in length and often covered / or passed beneath roads. Similarly, due to unplanned growth, untreated sewage/ industrial discharge into such drains, which ultimately meets first and second order drain (Figure – 1).

This sort of order of drain is defined as classic stream order, also called [Hack's stream order](#). Drains usually carry wastewater from Urban/Rural centers called domestic sewage or effluent from Industrial activities and surface runoff including agricultural runoff.

Therefore, drains could be broadly categorized as sewage drains carrying only sewage and mixed drains carrying sewage and industrial effluent.

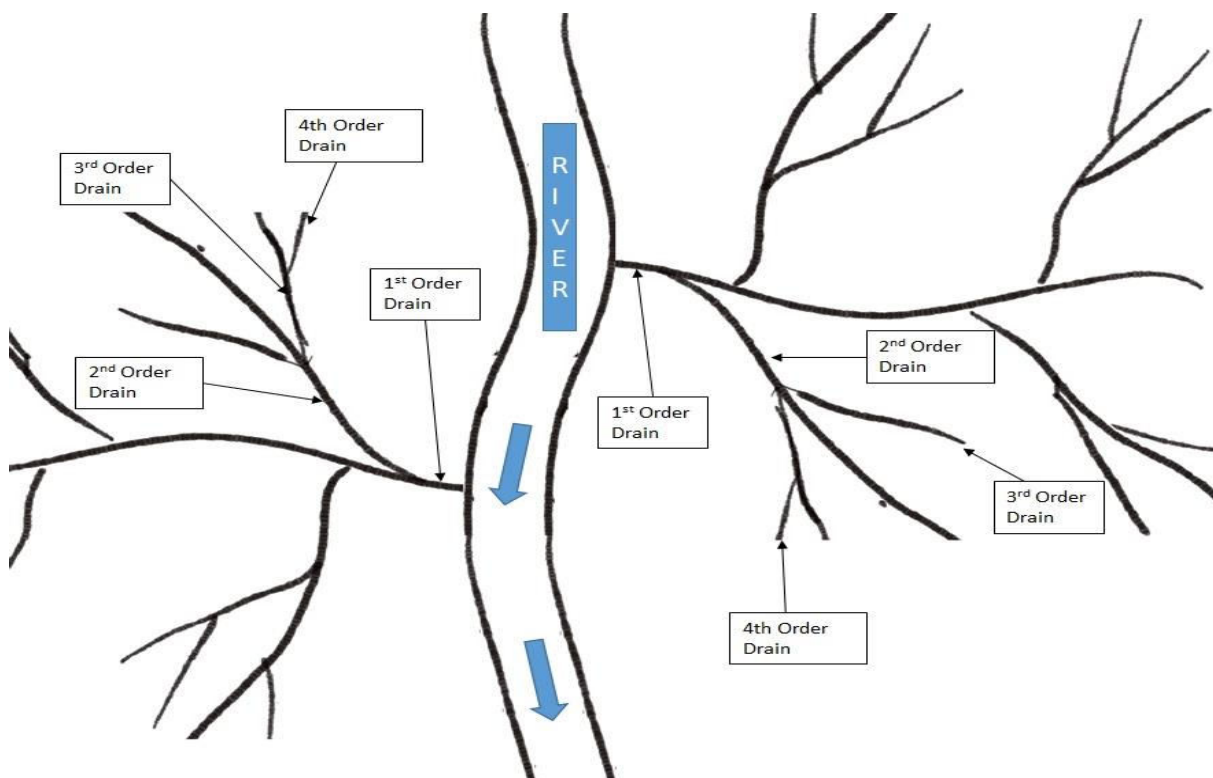

Figure 1 Drainage pattern of any city/town

Based on drain data available for River Ganga and its tributaries, categorization of drains has been made considering their hydrological characteristics namely, flow, pollution load and physical characteristics, which may influence selection of drain wastewater treatment technology.

Flow – Based on flow drain can be classified as,

- <20MLD – Minor Drain
- 20 – 50 MLD – Medium Drain
- >50 MLD – Major Drain

Pollution Load – Based on pollution load in terms of BOD concentration, drains can be classified as,

- <50 mg/l – Low Pollution Load
- 50-100 mg/l – Modern Pollution Load
- >100 mg/l – High Pollution Load

Width – Based on channel width, drains can be classified as,

- <3m – Narrow Drain
- 3 – 15m – Wide Drain
- >15m – Broad Drain

Drain could also be characterized based on the criteria such as drain traversing through hilly terrain, rocky terrain, plain, marshy area and draining into different recipient water body like river, lakes, pond and sea.

4. ALTERNATIVE TREATMENT TECHNOLOGIES

4.1 IN-SITU BIOREMEDIATION TECHNIQUES

In-Situ bioremediation techniques involve treatment at the site using aquatic plants and/or microbial remediation methods. *In-Situ* treatment systems can be commissioned in lower time duration (few months only), is easy to operate, and requires less energy as compared to conventional treatment technologies. *In-situ* treatment, depending on effluent characteristics, site conditions, and type of treatment systems, may either provide desired quality of treated effluent or act as supplementary to conventional treatment technologies. In any case, wherever feasible, it can be used as an interim remedial measure and help in reducing pollution load or polishing of treated effluent from Sewage Treatment Plants. The common *in-situ* treatment systems are Microbial Bioremediation, Phytoremediation, Constructed Wetland System and Root Zone Treatment. Adequate space and appropriate flow are general requirements for adoption of these technologies. Details of above mentioned *In-situ* bioremediation techniques indicating methodology, parameters for the feasibility assessment, existing experiences, etc. are as follow:

4.1.1 Phytoremediation

Phytoremediation is a bioremediation process that uses various types of plants to remove, transfer, stabilize, and/or destroy contaminants in the soil and groundwater. Phytoremediation involves the removal of organic compounds and nutrients from wastewater through bio-sorption/uptake by pollution-tolerant aquatic plants (such as algae, water hyacinth, duckweeds, etc.) growing in the wastewater. Quite often such plants grow along the littoral zones on either side of the drain.

4.1.2 Constructed Wetlands (CWs)

CWS also uses principle of Phytoremediation techniques. It integrates microbial bioremediation, phytoremediation and root-zone treatment in addition to providing the benefits of oxidation pond and physical filters.

Constructed wetlands (CWs) are scientifically proven and widely adopted across the world as alternative and complementary technology to conventional technologies for sewage treatment. A well-designed constructed wetland system will work on the same principle as that of STP but with greater microbial diversity associated with diverse plant

species that effectively biodegrade organics and other pollutants in sewage and without energy.

A constructed wetland is highly versatile and can be designed for drains that have different topography hydraulics and physical characteristics of the drain (width, length, height). A constructed wetland system can be used as primary/ secondary/ tertiary treatment and with continuous flow. Figure 2 depicts schematic flow diagram of a Constructed Wetland System.

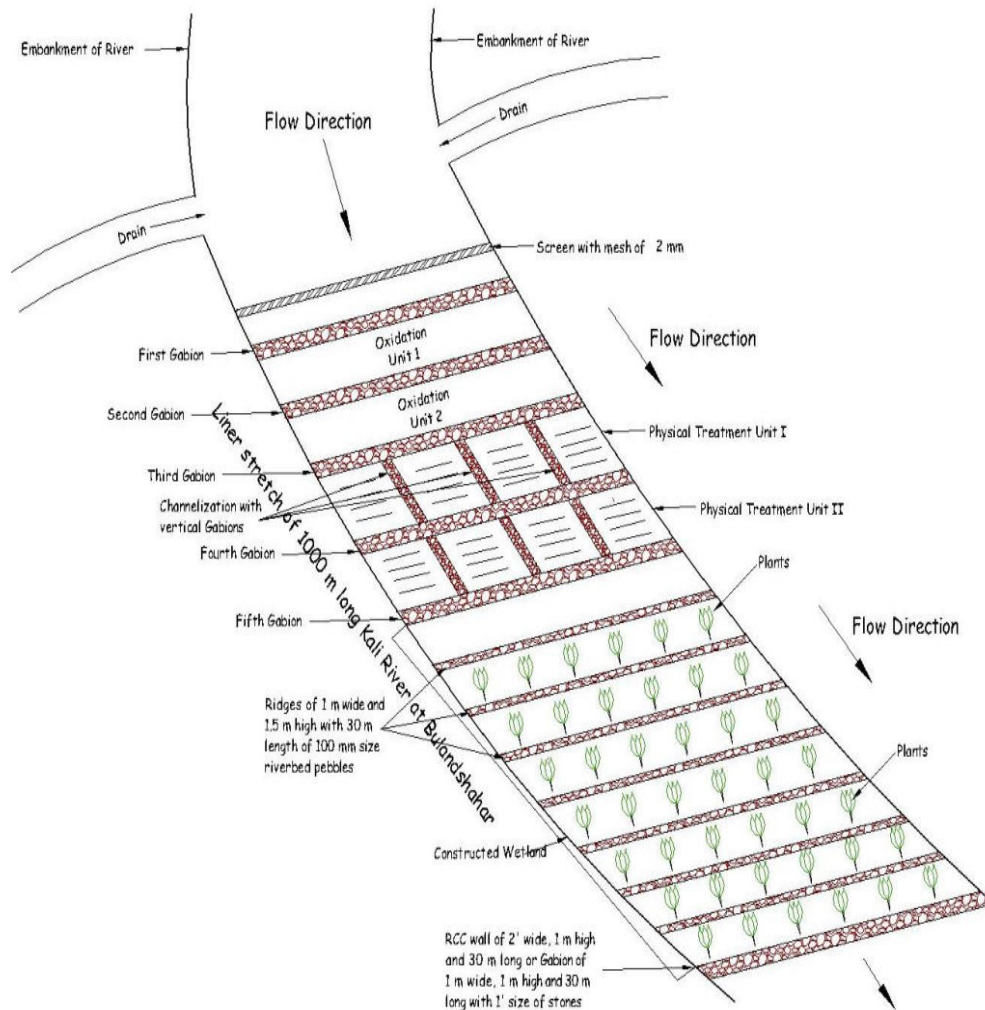

Figure 2 Schematic Diagram of Constructed Wetland Systems

A typical CW system should have the following components:

- i. An aerobic oxidation pond with depth of water ranging from < 1m to 5m; water may be retained for at least 8-10 hours and consequently there may be slight rise in the water level (up to 30cm) from the normal water level in the drain.
 - (a) there may be a screen (iron mash having 4-10 mm aperture) before the oxidation pond to remove solid waste and another screen (2-4 mm aperture) before water

- enters into two physical filter tanks / chambers/ zones/ channels from oxidation pond.
- ii. Three physical filter tanks/ chambers/ channels/ zones are ideal for efficient functioning; the physical filter chambers are separated by gabions of boulders of different sizes and embedded in iron mesh.
 - (a) the first chamber/ channel/ zone is separated from the second chamber by a gabion made of boulders of 2' within the chamber channel and there will be 3 ridges made of stones/ pebbles of 200 to 250 mm.
 - (b) The second chamber is separated from third chamber by a gabion made of boulders of 1' size with 3-4 ridges of pebbles of 180 mm.
 - (c) The third chamber is separated from the constructed wetland by gabion made of boulders of 1' size with 3 to 4 ridges of river bed pebbles of 150 -120 mm.
 - iii. Constructed wetland having 5-10 furrows of 1 to 4 m width separated by ridges of 1 m high, 0.5m wide and composed of river bed pebbles of 80-50 mm size.
 - iv. Cascade outlet is made of boulders, stones and pebbles with gentle slope from the overflow of the constructed wetlands. Water coming out from the cascade can be recycled /stored in stagnant water bodies / wetland or channelized into the downstream of the drain or river.

Note:

- i. The height of gabions should be 1.0 m 1.5 m high and usually above the water level in the channels/ chambers/ ponds/ zones.
- ii. The typical CW system outlined above is for in situ biological remediation where the sides of the chambers/ ponds/ channels / zones are the embankments of the drains.
- iii. For ex-situ biological remediation, the four sides of chambers/ponds/ tanks should be made of stone meshed walls of 1.5 -2 m high and 0.5 m – 1 m wide and all the components should be contiguous with gradient so that water flows on its own. If a gradient does not exist, a gradient channel has to be constructed.

4.1.3 Microbial Bioremediation

Microbial bioremediation involves periodic or continuous dosing of special waste-treating microbes, fungi and /or plants and their products (such as enzymes) in adequate quantity to the wastewater mass. The effectiveness of bioremediation depends on both the wastewater characteristics, the microorganisms and products that are used for dosing, the dosing amount, frequency of dosing and the environmental conditions.

Microbial bioremediation could be intrinsic (within the drain using natural consortia of microorganisms) or in vitro (using an engineered treatment system).

Microorganisms are used to treat mainly the organic matter; small quantity of inorganic materials and metals are also consumed as nutrients. Direct use of enzymes is done in biochemical treatment. It may be noted that aerobic microbes need less time, whereas anaerobic microbes need more time to degrade the waste.

Flow and retention time: This type of bioremediation requires retention time of 20 -30 hours, therefore may be suitable for drains with low flow.

Output of the process could vary where flow rates are variable and high, which could partly be due to rapid wash out of the material dosed from drains during high flow pulses. Drains often need interventions to slow down the flow rates. Also, the process being inherently slow will achieve good performance in larger span of time.

Domestic wastewater also gets mixed with the effluents from industries which invariably carry inorganic pollutants thereby impacting the microbial load. While there have been claims of successful treatment of municipal wastewater by bioremediation with various microorganisms and inoculums, these claims require re-verification for a sustained period.

The system requires a kind of bio-reactor to meet the retention time and as such it requires a large area /stretch to provide the requisite retention time and the microbial diversity is limited and is composed of consortia of known microbes. There is recurring cost for maintaining microbial consortia as bio-media has to be added in running stream at regular intervals.

Further, the successful use of this bioremediation technique for in-situ treatment of wastewater-carrying drains, would necessitate periodic removal of bio-sludge generated over time from the drains to avoid choking of the drains and/or addition of pollution load on the receiving water body by transporting the sludge generated.

There is a requirement for well-defined specifications in case of this type of bioremediation since the microbial composition and doses are usually trade secrets and claims are unverifiable and comparable.

Current application of microbial bioremediation carried out by NMCG in 144 drains depicts better results in drains having flow less than 10 MLD. Therefore, such intervention can be applied in low hydraulic load and its expected outcome shall be within 50 %.

4.2 Ex-Situ Remediation Techniques

Ex-situ remediation technique includes constructed wetland, waste stabilization pond, aerated lagoon and oxidation pond. Design and performance details are attached as Annexure-I. Details of ex-situ techniques are given below:

4.2.1 Waste stabilization pond

Waste or Wastewater Stabilization Ponds (WSPs) are large, man-made water bodies in which Blackwater, greywater or faecal sludge are treated by natural occurring processes and the influence of solar light, wind, microorganisms and algae. The ponds can be used individually, or linked in a series for improved treatment. There are three types of ponds,

- (1) anaerobic,
- (2) facultative and
- (3) aerobic (maturation),

each with different treatment and design characteristics. WSPs are low-cost for O&M and BOD and pathogen removal is high. However, large surface areas and expert design

are required. Effluent contains nutrients (e.g. N and P) and is therefore appropriate for reuse in agriculture, but not for direct discharge in surface waters.

4.2.2 Mechanically Aerated Lagoon

Mechanically aerated lagoons are earthen basins generally 2.5 to 5m deep, provided with mechanical aerators installed on floats or fixed columns. Raw sewage is fed from one end into lagoon (after screening) and it leaves from the other end after desired period of aeration. Aerated lagoons are smaller in size (less than 10-20%) compared to waste stabilization ponds. Three types of aerated lagoons can be distinguished as mentioned below:

1. Facultative aerated Lagoons

Facultative aerated lagoons consist of a shallow basin in which settleable solids introduced by the wastewater settle to the bottom to form a sludge layer that decomposes anaerobically. Biodegradable organic materials that do not settle are degraded aerobically. The term facultative aerated describes the aerobic-anaerobic nature of the lagoon - an anaerobic bottom region covered by an aerobic top layer. Process of oxygenation is enhanced through floating aerators in upper section of lagoon. Lower section of lagoon maintains anaerobic conditions. The power input per unit volume is only sufficient for diffusing required amount of oxygen into liquid, but not sufficient for maintaining all the solids in suspension (Figure – 3).

Consequently, some of the suspended solids entering the Lagoon and some of the new solids produced in the lagoon as a result of substrate removal tend to settle down and undergo anaerobic decomposition at the bottom. They are capable of giving 70-90% BOD removal from domestic sewage.

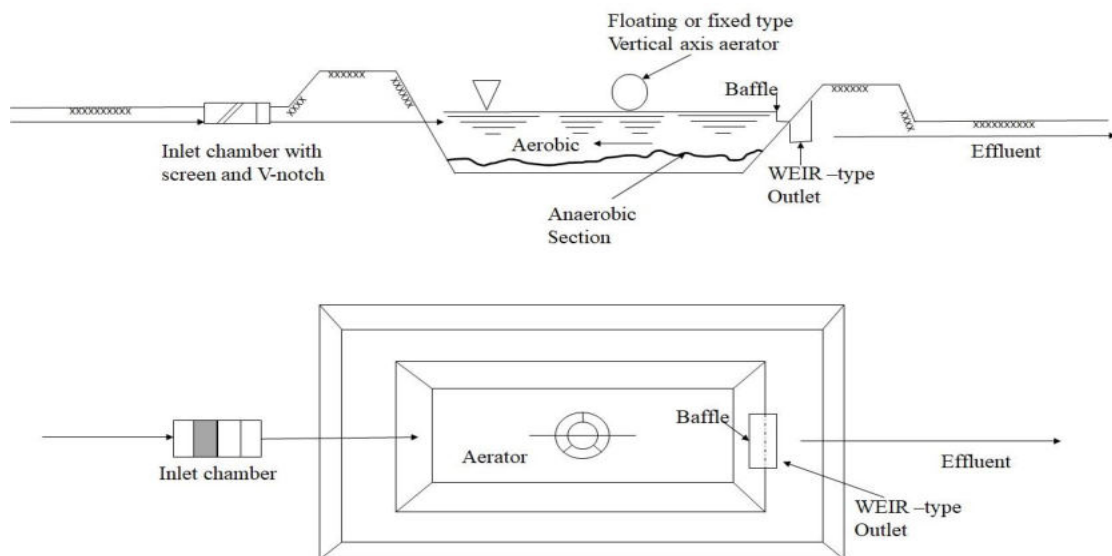

Figure 3: Mechanical aerated facultative lagoon

2. Aerobic flow-through Lagoons

Aerobic flow-through lagoons use aerators to mix the effluent in the pond and add oxygen to the wastewater. In aerobic flow through lagoons, oxygen transfer is maintained throughout the depth of the lagoon. The power level is high enough not only to diffuse adequate oxygen into the liquid but also to keep all solids in suspension as in an activated sludge aeration tank (Figure – 4). Additional treatment (such as stabilization pond) is necessary if better BOD and solid removal is desired.

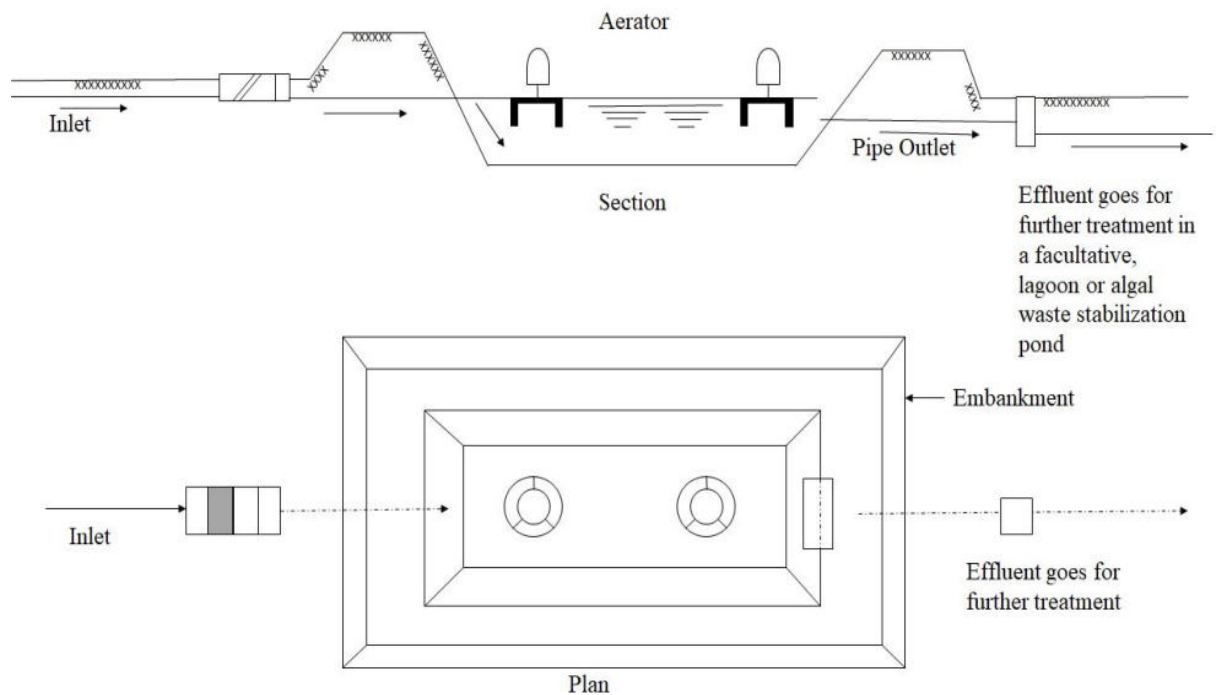

Figure 4 Mechanical aerated flow through type lagoon

3. Aerobic lagoons with recycling of solids

In aerobic lagoons, oxygenation of effluent and retention of recyclable solids is carried out. In these lagoons, power input level is sufficient to meet the oxygen requirement as well as to keep all solids in suspension. The efficiency of BOD removal in these types of lagoons can be as high as 95-98%. and nitrification can also be achieved (Figure – 5).

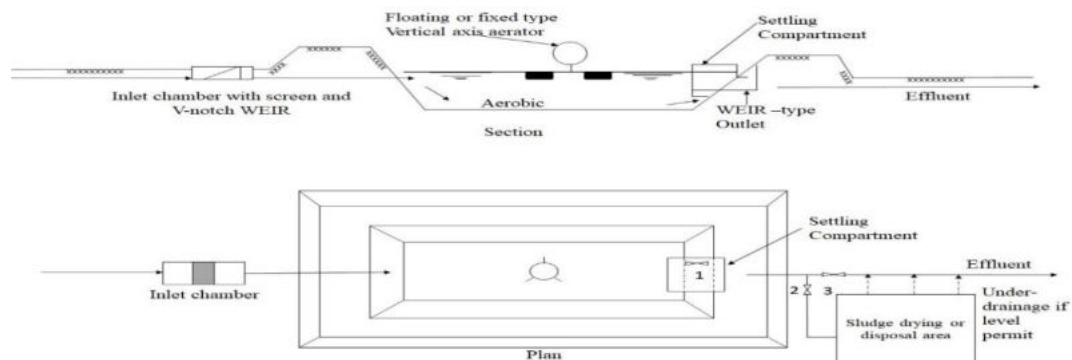

Figure 5: Typical mechanical aerated lagoon system

5. CRITERIA FOR SELECTION OF ALTERNATIVE TREATMENT TECHNOLOGIES FOR REJUVENATION OF DRAINS

The effective biological *in-situ* treatment system should need the following requirements:

- i) *In situ* treatment should be different from conventional centralized or decentralized treatment system.
- ii) It should be a rapid system having commissioning time of less than six to twelve months.
- iii) The *in situ* treatment system should have the ability to treat the sewage in a continuous manner throughout the year.
- iv) The treatment system must have a well-defined inlet and outlet along with minimum modification in natural drain structure.
- v) The treatment system should work on zero/negligible power consumption.
- vi) The treatment system should have a designed life and minimum operational constraints.
- vii) It should not have high capital cost and recurring cost as compared with conventional *ex situ* treatment technology currently in practice.
- viii) The design life should be up to 15 years at optimum operation condition.
- ix) In case of drains having flow >20 MLD, the system may be developed in modular form having 2-3 blocks of treatment within one treatment stretch.
- x) The treatment system must be capable of degrading/reducing the soluble and insoluble organic materials.
- xi) Removal efficiency of soluble BOD at the final designated outlet should not be less than 60% in terms of organic load reduction with treated wastewater quality at designated outlet of pH 6.5-8.5, DO \geq 5mg/l and BOD \leq 20 mg/l, whichever is stringent.
- xii) *In-situ* treatment shall be accompanied with pre-treatment/ physical solid liquid separation as drains carry large quantity of solid waste.
- xiii) The generated sludge must be quantified and cleaned based on requirement preferentially at every 15 days within the defined stretch. If required, dredging should be done to maintain the depth.
- xiv) The system must not hinder the flow and not result in ponding at the upstream site of the drain.
- xv) Flow measuring device (such as V-notch, EM meter etc.) may be installed at the inlet/outlet of the treatment stretch so as to control the treatment based on flow and assessment of daily treated volume.
- xvi) Treatment system shall be installed at such a location/manner and for such volume of drains that the treated effluent quality at defined outlet shall be maintained throughout the entire downstream stretch of the drain till confluence with the river. If required, treatment system could be set up in series in entire drain stretch.
- xvii) Treatment system shall be set up for inlet wastewater quality of BOD \geq 40mg/l.

6. SCHEMES/MODELS FOR DIFFERENT ORDERS OF DRAIN

Categorization of drains are made based on the experience of drain monitoring in Ganga Catchment. Schemes/ Models defined for treatment are generic and suggestive in nature and any application of such model requires specific design as per site requirements. The land requirements mentioned are indicative and it shall be worked out as per the design criteria. Summary of different treatment schemes is shown in table 1

6.1 Model 1: Minor sewage drain with moderate pollution load & broader channel

a) Drain hydrological characteristics:

➤ Physical Characteristics of Drainage System

Width of Drain : > 15 Meter
Depth of Flowing Water : 1 - 3 Meter

➤ Organic Loading

BOD : < 100 mg/l

➤ Hydraulic Loading

Flow : < 20 MLD

b) **Treatment scheme:** Oxidation ponds/ Facultative pond (1-2 no.) + Physical Treatment unit + wetland/phytoremediation or waste stabilization pond

c) **Applicability:** This type of treatment scheme is suitable for drains carrying moderate pollution load sewage with wide channel suitable for in-situ construction. This type of model is suitable for 1st and 2nd order drains.

d) **Design aspect:** Depending on the space availability and the flow rates of the 1st and 2nd order drain, oxidation pond, and a wetland with furrows and ridges should be developed. The ridges are made of stones/ pebbles specified in the typical model. Area and depth requirement for such system shall be worked out as per design criteria (Figure 6). In *in-situ* treatment techniques, length of the drain is only variable parameter for area calculation whereas available width of drain will remain fixed. Therefore, any design for *in-situ* is dependent on length of the drain.

e) Schematic diagram:

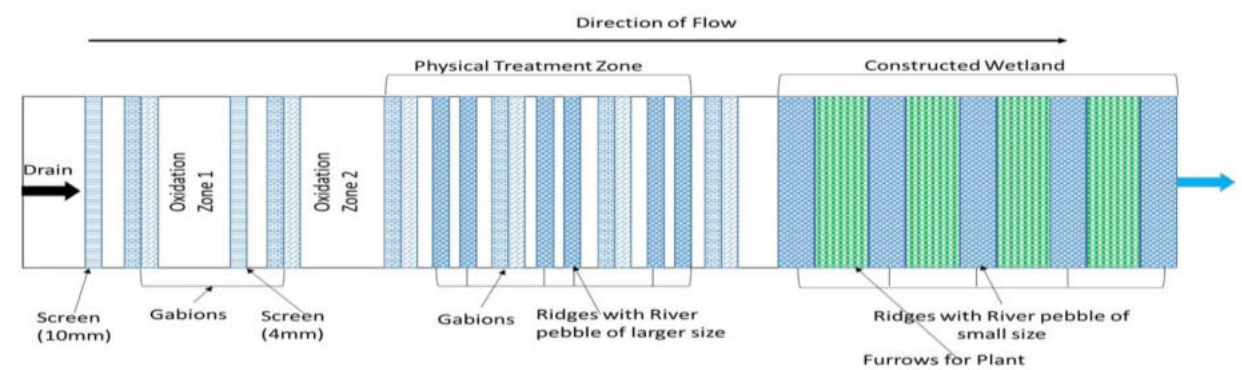

Figure 6 Schematic layout of *in-situ* Biological Remediation

6.2 Model 2: Minor sewage drain with moderate pollution load & wide channel

a) Drain hydrological characteristics:

➤ Physical Characteristics of Drainage System

Width of Drain : 3-15 Meter

Depth of Flowing Water : 1 - 3 Meter

➤ Organic Loading

BOD : < 100 mg/l

➤ Hydraulic Loading

Flow : < 20 MLD

b) **Treatment scheme:** Oxidation ponds/ Facultative pond (1-2 no.) + Physical Treatment unit + wetland/phytoremediation or waste stabilization pond

c) **Applicability:** This type of treatment scheme is suitable for drains carrying moderate pollution load sewage with wide channel suitable for in-situ construction. This type of model is suitable for 2nd and 3rd order drains. For hilly areas, such system has to be developed in the marshy depressions/valleys. In other words, it will be developed at the confluence of the drain with depression /low lying area in the valley.

d) **Design aspect:** Depending on the space availability and the flow rates of the 2nd and 3rd order drain, dimensions of oxidation pond and a wetland need to be customised based on the available flow width to provide the required hydraulic time of at least 20 hr in oxidation pond and wetland system. Treatment scheme configuration may be customised In-situ/ Ex-situ based on the flow width. Area and depth requirement for such system shall be worked out as per design criteria (Figure – 7).

e) Schematic diagram:

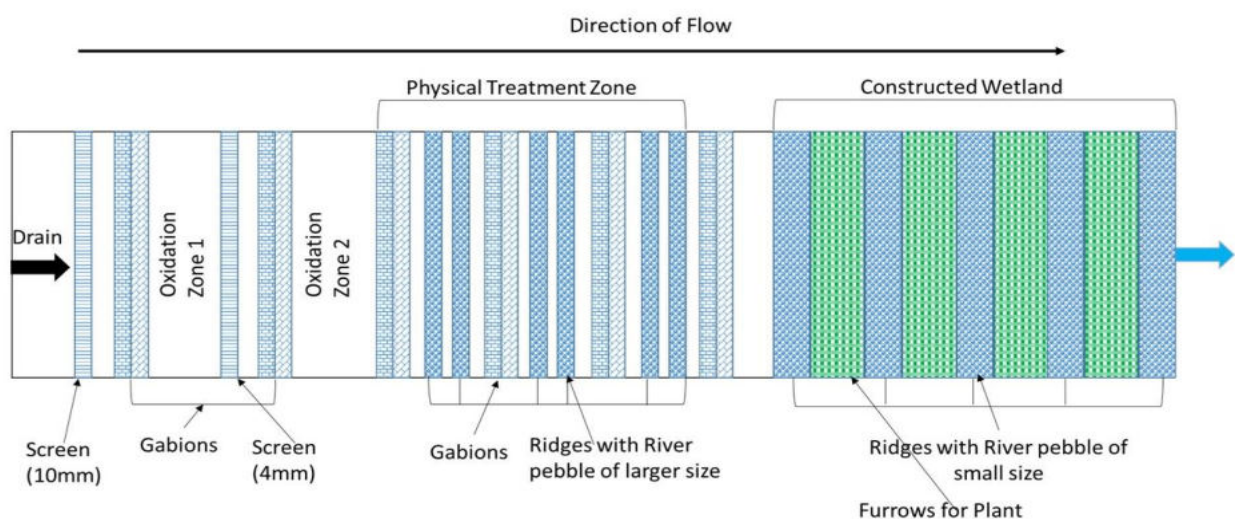

Figure 7 Schematic layout of *in-situ* Biological Remediation

6.3 Model 3: Minor sewage drain with moderate pollution load & narrow channel

a) Drain hydrological characteristics:

➤ Physical Characteristics of Drainage System

Width of Drain : < 3 Meter
Depth of Flowing Water : 1 - 3 Meter

➤ Organic Loading

BOD : < 100 mg/l

➤ Hydraulic Loading

Flow : < 20 MLD

b) **Treatment scheme:** Oxidation ponds/ Facultative pond (1-2 no.) + Physical Treatment unit + wetland/phytoremediation or waste stabilization pond or Ex-Situ Activated Sludge Method

c) **Applicability:** This type of treatment scheme is suitable for drains carrying moderate pollution load sewage with channel width of less than 3m. This type of model is suitable for 3rd or higher order drains. For hilly areas, such system has to developed in the marshy depressions/valleys. In other words, it will be developed at the confluence of the drain with depression /low lying area in the valley.

d) **Design aspect:** Due to less flow width, In- situ treatment is generally not feasible in these categories of drains. Ex situ model may be best suitable for providing sufficient hydraulic retention time in oxidation pond + wetland system or Waste Stabilization Pond as per the space available. Area and depth requirement for such system shall be worked out as per design criteria (Figure – 8).

e) Schematic diagram:

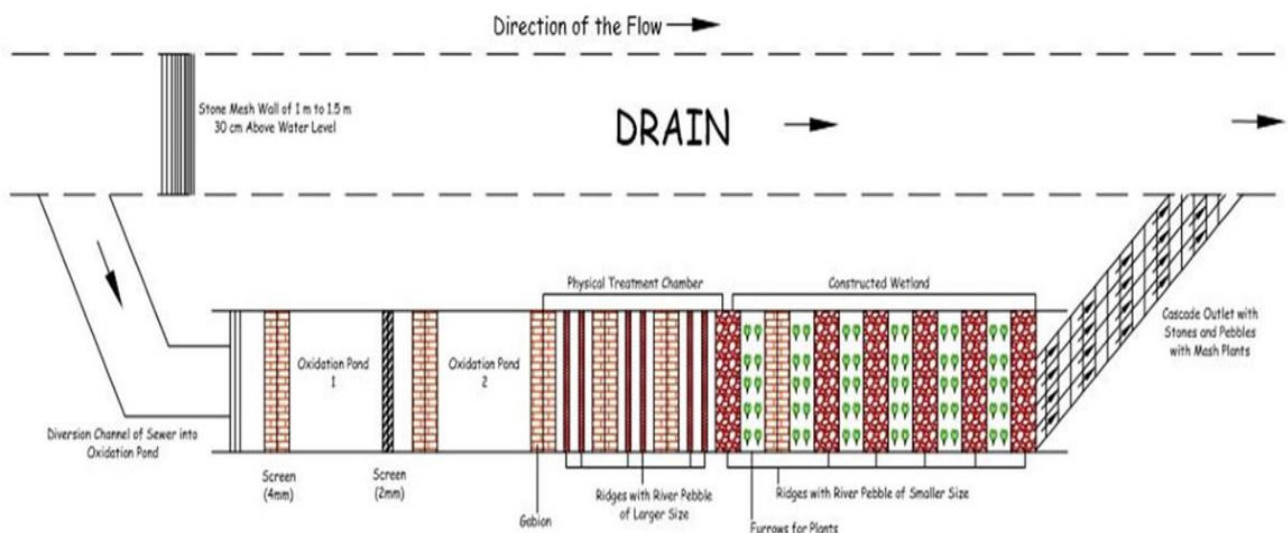

Figure 8 Schematic layout of *ex-situ* Biological Remediation

6.4 Model 4: Minor sewage drain with high pollution load & broader channel

a) Drain hydrological characteristics:

➤ Physical Characteristics of Drainage System

Width of Drain : > 15 Meter

Depth of Flowing Water : 0.5 - 2 Meter

➤ Organic Loading

BOD : >100 mg/l

➤ Hydraulic Loading

Flow : < 20 MLD

b) **Treatment scheme:** Oxidation pond + Physical Treatment unit + constructed wetland system or Waste Stabilization Pond

c) **Applicability:** This type of treatment scheme is suitable for drains carrying high pollution load (untreated sewage + industrial effluent) with channel width more than 15 m. This type of model is suitable for 1st and 2nd order drains.

d) **Design aspect:** Depending on the space availability and the flow rates of the 1st and 2nd order drain, oxidation pond, and a wetland with furrows and ridges should be developed. The ridges are made of stones/ pebbles specified in the typical model. Area and depth requirement for such system shall be worked out as per design criteria (Figure – 9). In in-situ treatment techniques, length of the drain is only variable parameter for area calculation whereas available width of drain will remain fixed. Therefore, any design for *in-situ* is dependent on length of the drain.

e) Schematic diagram:

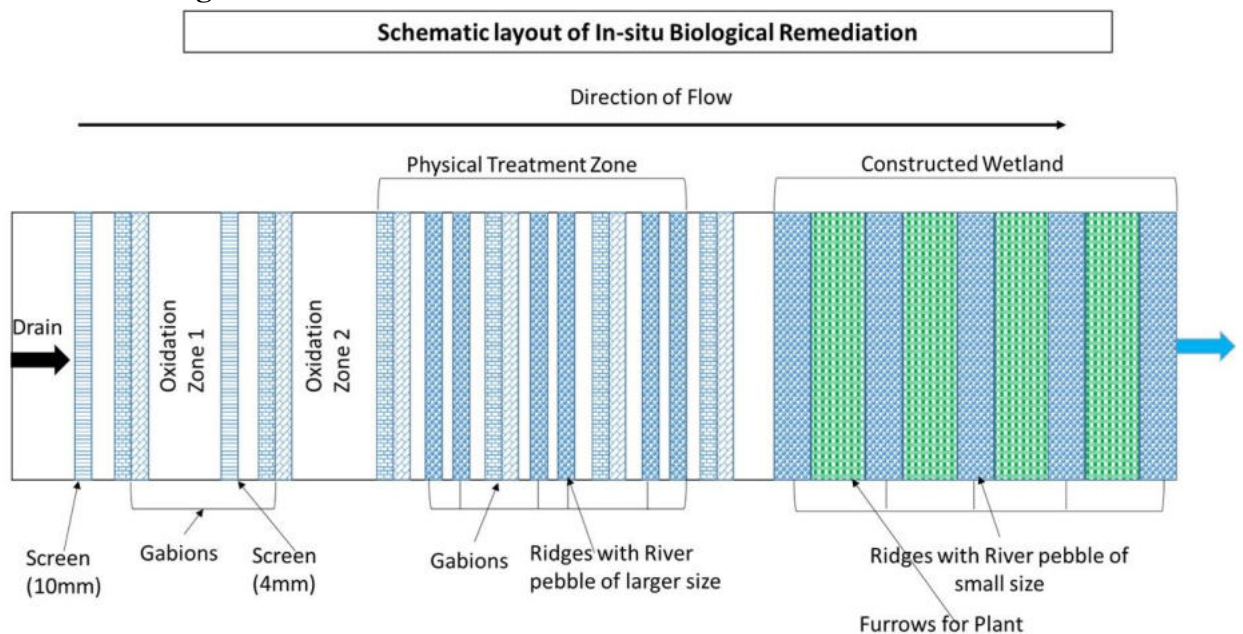

Figure 9: Schematic layout of *in-situ* Biological Remediation.

6.5 Model 5: Minor sewage drain with high pollution load & wide channel

a) Drain hydrological characteristics:

➤ Physical Characteristics of Drainage System

Width of Drain : 3- 15 Meter

Depth of Flowing Water : 0.5 - 2 Meter

➤ Organic Loading

BOD : >100 mg/l

➤ Hydraulic Loading

Flow : < 20 MLD

b) **Treatment scheme:** Oxidation pond + Physical Treatment unit + constructed wetland system or Waste Stabilization Pond

c) **Applicability:** This type of treatment scheme is suitable for drains carrying high pollution load (untreated sewage + industrial effluent) with channel width 3-15 m. This type of model is suitable for 1st and 2nd order drains.

d) **Design aspect:** Depending on the space availability and the flow rates of the 2nd and 3rd order drain, dimensions of oxidation pond and a wetland need to be customised based on the available flow width to provide the required hydraulic time of at least 20 hr in oxidation pond and wetland system. Treatment scheme configuration may be customised In-situ/ Ex-situ based on the flow width. Area and depth requirement for such system shall be worked out as per design criteria (Figure 10).

e) Schematic diagram:

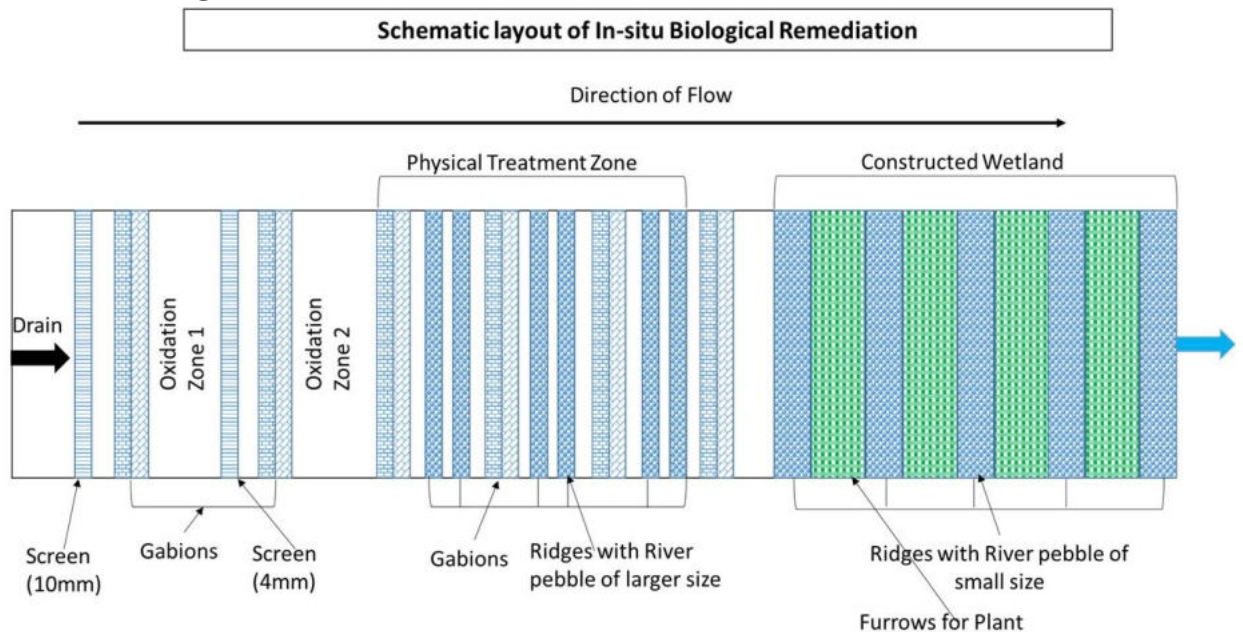

Figure 50 Schematic layout of *in-situ* Biological Remediation.

6.6 Model 6: Minor sewage drain with high pollution load & narrow channel

a) Drain hydrological characteristics:

➤ Physical Characteristics of Drainage System

Width of Drain : < 3 Meter
Depth of Flowing Water : 0.5 - 2 Meter

➤ Organic Loading

BOD : >100 mg/l

➤ Hydraulic Loading

Flow : < 20 MLD

b) **Treatment scheme:** Oxidation pond + wetland system or Waste Stabilization Pond

c) **Applicability:** This type of treatment scheme is suitable for drains carrying only low pollution load untreated sewage with channel width of less than 3m. This type of model is suitable for 3rd or higher order drains.

d) **Design aspect:** Due to less flow width, In- situ treatment is generally not feasible in these categories of drains. Ex situ model may be best suitable for providing sufficient hydraulic retention time in oxidation pond + wetland system or Waste Stabilization Pond as per the space available. Area and depth requirement for such system shall be worked out as per design criteria (Figure – 11).

e) Schematic diagram:

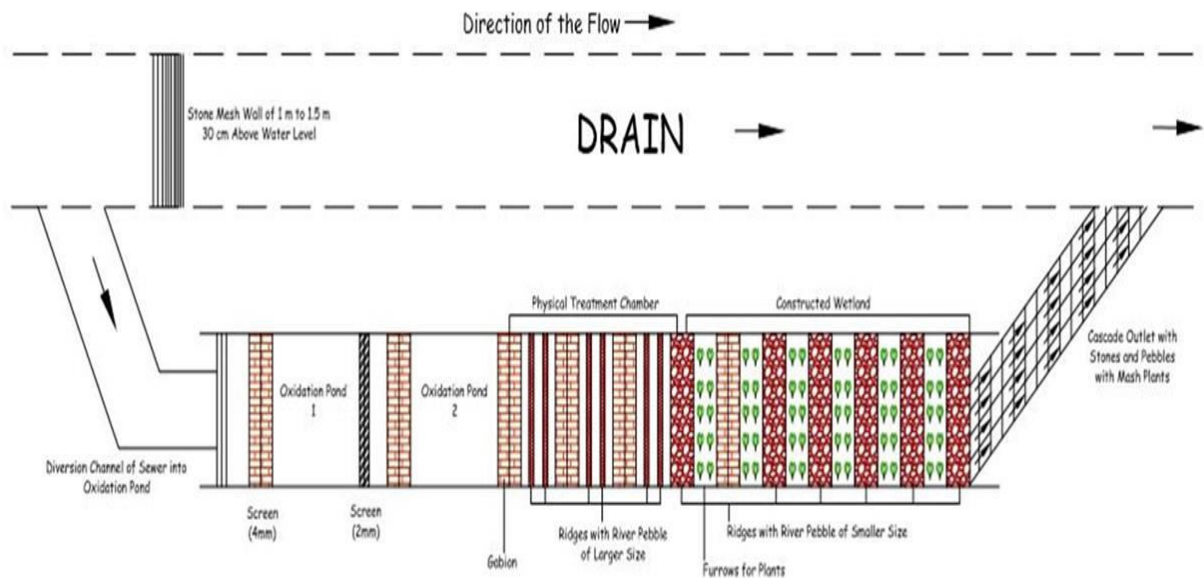

Figure 11: Schematic layout of *ex-situ* Biological Remediation.

6.7 Model 7: Medium sewage drain with low pollution load & broader channel

a) Drain hydrological characteristics:

➤ Physical Characteristics of Drainage System

Width of Drain : > 15 Meter

Depth of Flowing Water : 1 - 3 Meter

➤ Organic Loading

BOD : < 50 mg/l

➤ Hydraulic Loading

Flow : < 50 MLD

b) **Treatment scheme:** Facultative ponds (1-2 no.) + Lagoon + oxidation pond + wetland/phytoremediation or Oxidation pond + Physical Treatment unit + Constructed wetland or waste stabilisation pond

c) **Applicability:** This type of treatment scheme is suitable for drains carrying only low pollution load sewage with wide channel suitable for in-situ construction. This type of model is suitable for 1st and 2nd order drains.

d) **Design aspect:** Depending on the space availability and the flow rates of the 1st and 2nd order drain, oxidation pond, and a wetland with furrows and ridges should be developed. The ridges are made of stones/ pebbles specified in the typical model. Area and depth requirement for such system shall be worked out as per design criteria (Figure – 12). In in-situ treatment techniques, length of the drain is only variable parameter for area calculation whereas available width of drain will remain fixed. Therefore, any design for *in-situ* is dependent on length of the drain.

e) Schematic diagram:

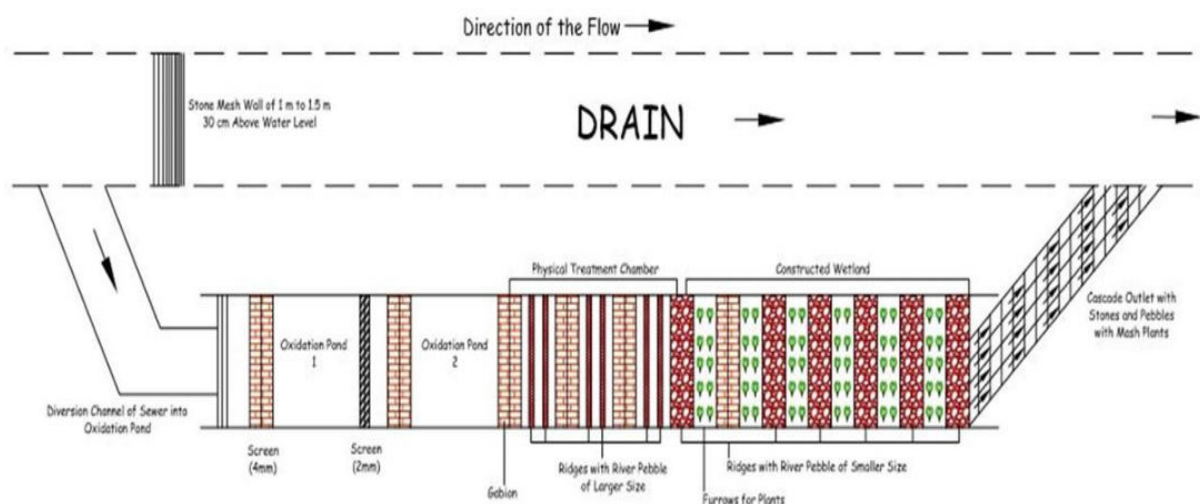

Figure 62 Schematic layout of *ex-situ* Biological Remediation

6.8 Model 8: Medium sewage drain with low pollution load & wide channel

a) Drain hydrological characteristics:

➤ Physical Characteristics of Drainage System

Width of Drain : 3- 15 Meter

Depth of Flowing Water : 1 - 2 Meter

➤ Organic Loading

BOD : < 50 mg/l

➤ Hydraulic Loading

Flow : < 50 MLD

b) **Treatment scheme:** Facultative ponds (1-2 no.) + Lagoon + oxidation pond + wetland/phytoremediation or Oxidation pond + Physical Treatment unit + Constructed wetland or waste stabilisation pond

c) **Applicability:** This type of treatment scheme is suitable for drains carrying only low pollution load untreated sewage with channel width of 3-15m. This type of model is suitable for 1st and 2nd order drains.

d) **Design aspect:** Depending on the space availability and the flow rates of the 2nd and 3rd order drain, dimensions of oxidation pond and a wetland need to be customised based on the available flow width to provide the required hydraulic time of at least 20 hr in oxidation pond and wetland system. Treatment scheme configuration may be customised as In-situ/ Ex-situ based on the flow width. Area and depth requirement for such system shall be worked out as per design criteria (Figure – 13).

e) Schematic diagram:

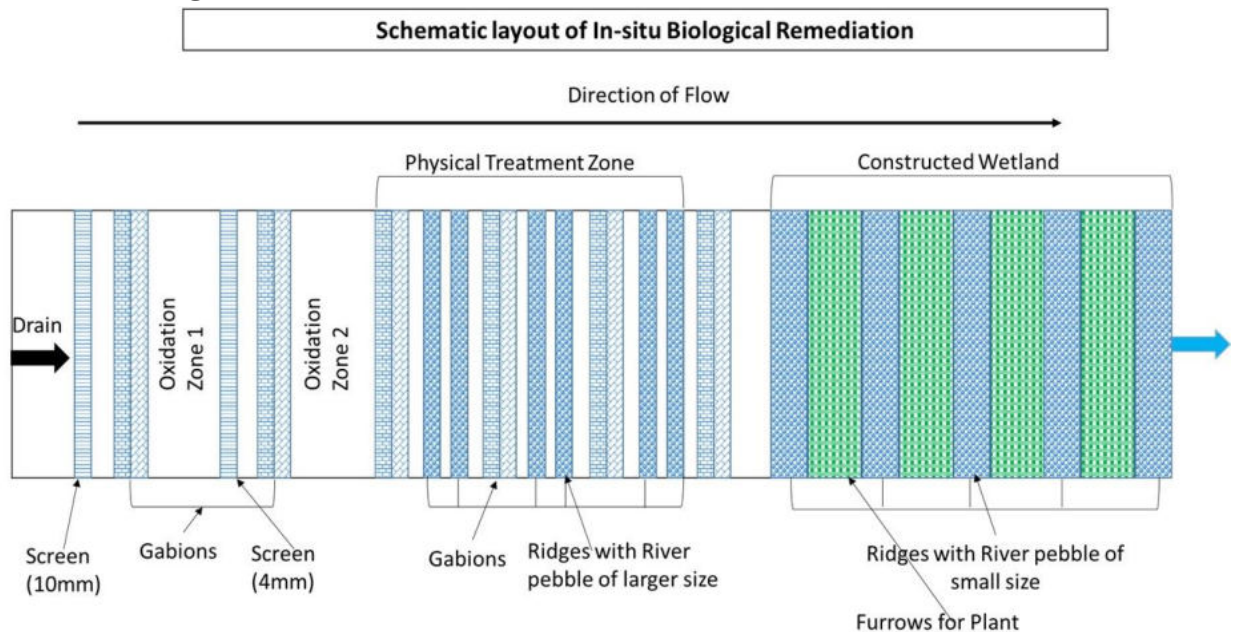

Figure 13 Schematic layout of *in-situ* Biological Remediation.

6.9 Model 9: Medium sewage drain with moderate pollution load & broader channel

a) Drain hydrological characteristics:

➤ Physical Characteristics of Drainage System

Width of Drain : > 15 Meter

Depth of Flowing Water : 1 - 3 Meter

➤ Organic Loading

BOD : < 100 mg/l

➤ Hydraulic Loading

Flow : < 50 MLD

b) **Treatment scheme:** Facultative ponds (1-2 no.) + Lagoon + oxidation pond + wetland/phytoremediation or Oxidation pond + Physical Treatment unit + Constructed wetland or waste stabilisation pond

c) **Applicability:** This type of treatment scheme is suitable for drains carrying moderate pollution load sewage with wide channel suitable for in-situ construction. This type of model is suitable for 1st and 2nd order drains.

d) **Design aspect:** Depending on the space availability and the flow rates of the 1st and 2nd order drain, oxidation pond, and a wetland with furrows and ridges should be developed. The ridges are made of stones/ pebbles specified in the typical model. Area and depth requirement for such system shall be worked out as per design criteria (Figure 14). In in-situ treatment techniques, length of the drain is only variable parameter for area calculation whereas available width of drain will remain fixed. Therefore, any design for *in-situ* is dependent on length of the drain.

e) Schematic diagram:

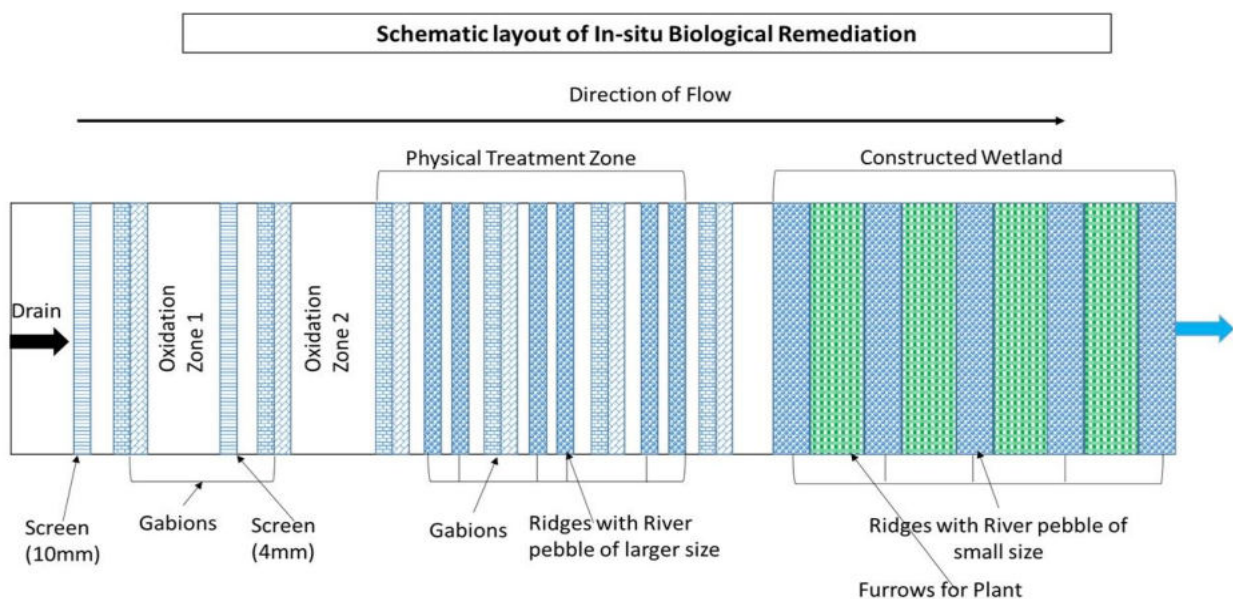

Figure 14: Schematic layout of *in-situ* Biological Remediation.

6.10 Model 10: Medium sewage drain with moderate pollution load & wide channel

a) Drain hydrological characteristics:

➤ Physical Characteristics of Drainage System

Width of Drain : 3- 15 Meter

Depth of Flowing Water : 1 - 2 Meter

➤ Organic Loading

BOD : < 100 mg/l

➤ Hydraulic Loading

Flow : < 50 MLD

b) **Treatment scheme:** Facultative ponds (1-2 no.) + Lagoon + oxidation pond + wetland/phytoremediation or Oxidation pond (2 no.) + Physical Treatment unit -2 no.) + Constructed wetland or waste stabilisation pond

c) **Applicability:** This type of treatment scheme is suitable for drains carrying moderate pollution load untreated sewage with channel width of 3-15m. This type of model is suitable for 1st and 2nd order drains.

d) **Design aspect:** Depending on the space availability and the flow rates of the 2nd and 3rd order drain, dimensions of oxidation pond and a wetland need to be customised based on the available flow width to provide the required hydraulic time of at least 20 hr in oxidation pond and wetland system. Treatment scheme configuration may be customised as *In-situ/ Ex-situ* based on the flow width. Area and depth requirement for such system shall be worked out as per design criteria (Figure – 15).

e) Schematic diagram:

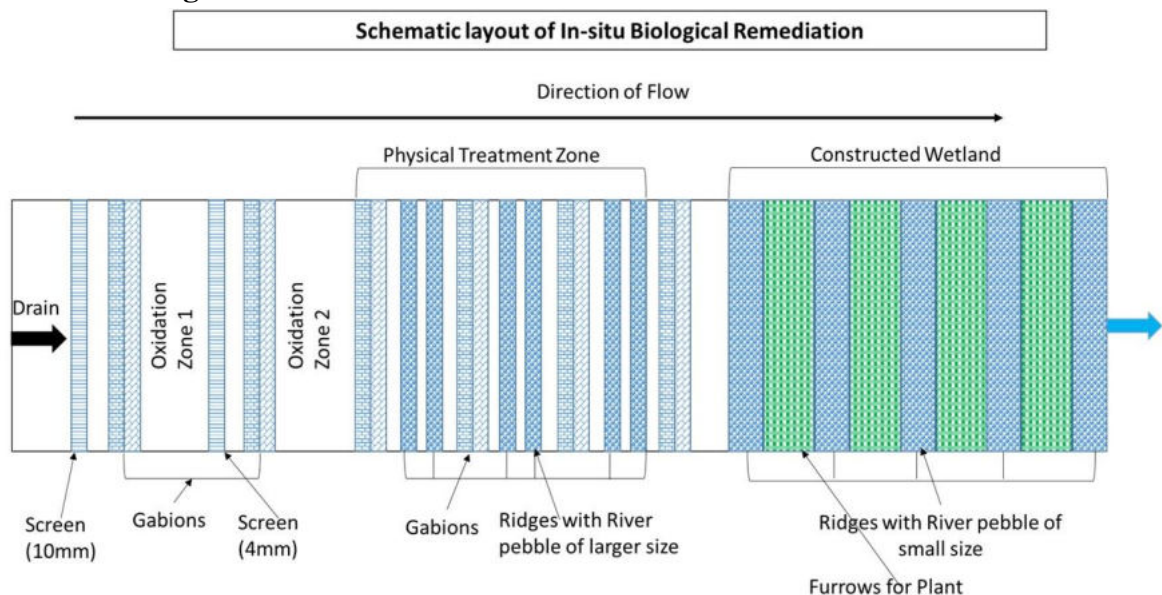

Figure 15: Schematic layout of *in-situ* Biological Remediation.

6.11 Model 11: Medium sewage drain with high pollution load & broader channel

a) Drain hydrological characteristics:

➤ Physical Characteristics of Drainage System

Width of Drain : > 15 Meter

Depth of Flowing Water : 1 - 3 Meter

➤ Organic Loading

BOD : > 100 mg/l

➤ Hydraulic Loading

Flow : < 50 MLD

b) **Treatment scheme:** Facultative ponds (1-2 no.) + Lagoon + oxidation pond + wetland/phytoremediation or Oxidation pond + Physical Treatment unit + Constructed wetland or waste stabilisation pond

c) **Applicability:** This type of treatment scheme is suitable for drains carrying high pollution load (untreated sewage + industrial effluent) with wide channel suitable for in-situ construction. This type of model is suitable for 1st and 2nd order drains.

d) **Design aspect:** Depending on the space availability and the flow rates of the 1st and 2nd order drain, oxidation pond, and a wetland with furrows and ridges should be developed. The ridges are made of stones/ pebbles specified in the typical model. Area and depth requirement for such system shall be worked out as per design criteria (Figure 16). In *in-situ* treatment techniques, length of the drain is only variable parameter for area calculation whereas available width of drain will remain fixed. Therefore, any design for *in-situ* is dependent on length of the drain.

e) Schematic diagram:

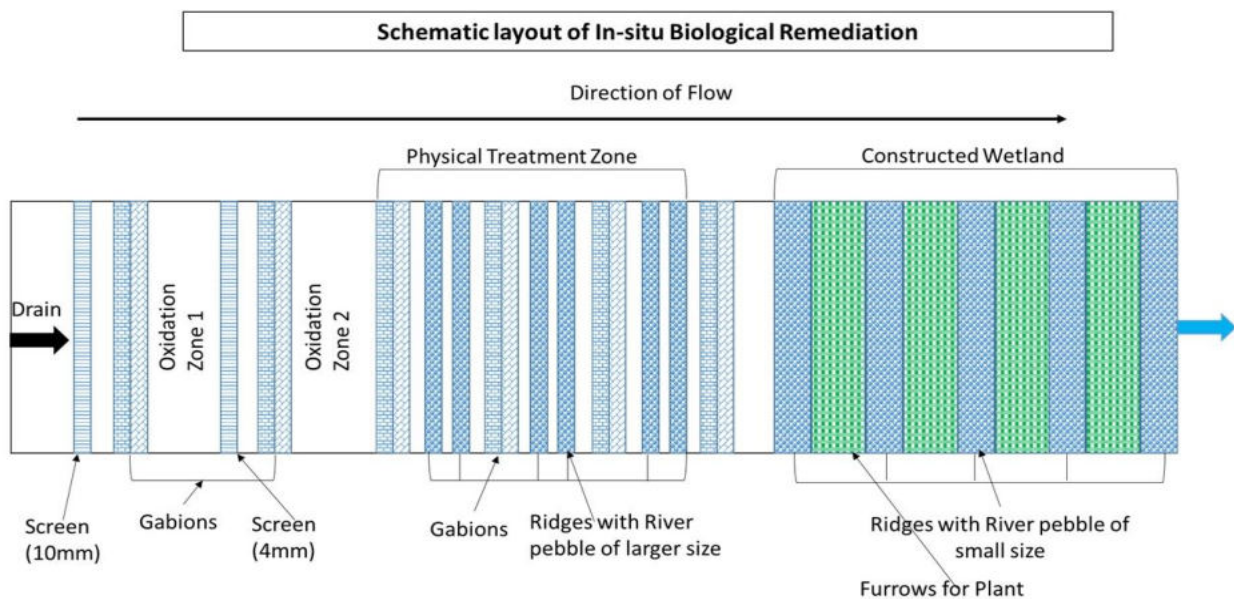

Figure 76: Schematic layout of *in-situ* Biological Remediation.

6.12 Model 12: Medium sewage drain with very high pollution load & broader channel

a) Drain hydrological characteristics:

➤ Physical Characteristics of Drainage System

Width of Drain : > 15 Meter

Depth of Flowing Water : 1 - 3 Meter

➤ Organic Loading

BOD : > 200 mg/l

➤ Hydraulic Loading

Flow : < 50 MLD

b) **Treatment scheme:** Pond with mud ball technology + Facultative ponds (1-2 no.) + Lagoon + oxidation pond + Lagoon+ wetland or Oxidation pond + Physical Treatment unit + Constructed wetland

c) **Applicability:** This type of treatment scheme is suitable for drains carrying high pollution load (untreated sewage + industrial effluent) with wide channel suitable for in-situ construction. This type of model is suitable for 1st and 2nd order drains.

d) **Design aspect:** Depending on the space availability and the flow rates of the 1st and 2nd order drain, oxidation pond, and a wetland with furrows and ridges should be developed. The ridges are made of stones/ pebbles specified in the typical model. Area and depth requirement for such system shall be worked out as per design criteria (Figure – 17). In *in-situ* treatment techniques, length of the drain is only variable parameter for area calculation whereas available width of drain will remain fixed. Therefore, any design for *in-situ* is dependent on length of the drain.

e) Schematic diagram:

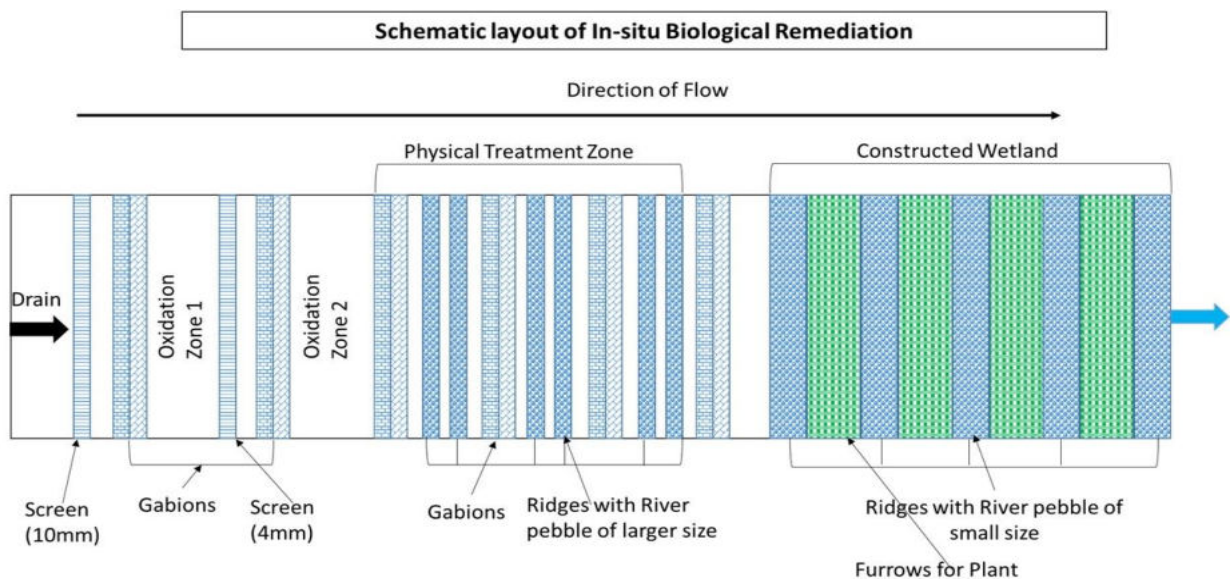

Figure 8 Schematic layout of *in-situ* Biological Remediation.

6.13 Model 13: Major sewage drain with low high pollution load & broader channel

a) Drain hydrological characteristics:

➤ Physical Characteristics of Drainage System

Width of Drain : > 15 Meter

Depth of Flowing Water : 1 - 3 Meter

➤ Organic Loading

BOD : < 50 mg/l

➤ Hydraulic Loading

Flow : 50 -100 MLD

b) **Treatment scheme:** Facultative ponds (1-2 no.) + Lagoon + oxidation pond + Lagoon+ wetland or Oxidation pond + Physical Treatment unit + Constructed wetland

c) **Applicability:** This type of treatment scheme is suitable for drains carrying low pollution load (untreated sewage only) with wide channel suitable for in-situ construction. This type of model is suitable for 1st and 2nd order drains.

d) **Design aspect:** Depending on the space availability and the flow rates of the 1st and 2nd order drain, oxidation pond, and a wetland with furrows and ridges should be developed. The ridges are made of stones/ pebbles specified in the typical model. Area and depth requirement for such system shall be worked out as per design criteria (Figure 18). In in-situ treatment techniques, length of the drain is only variable parameter for area calculation whereas available width of drain will remain fixed. Therefore, any design for *in-situ* is dependent on length of the drain.

e) Schematic diagram:

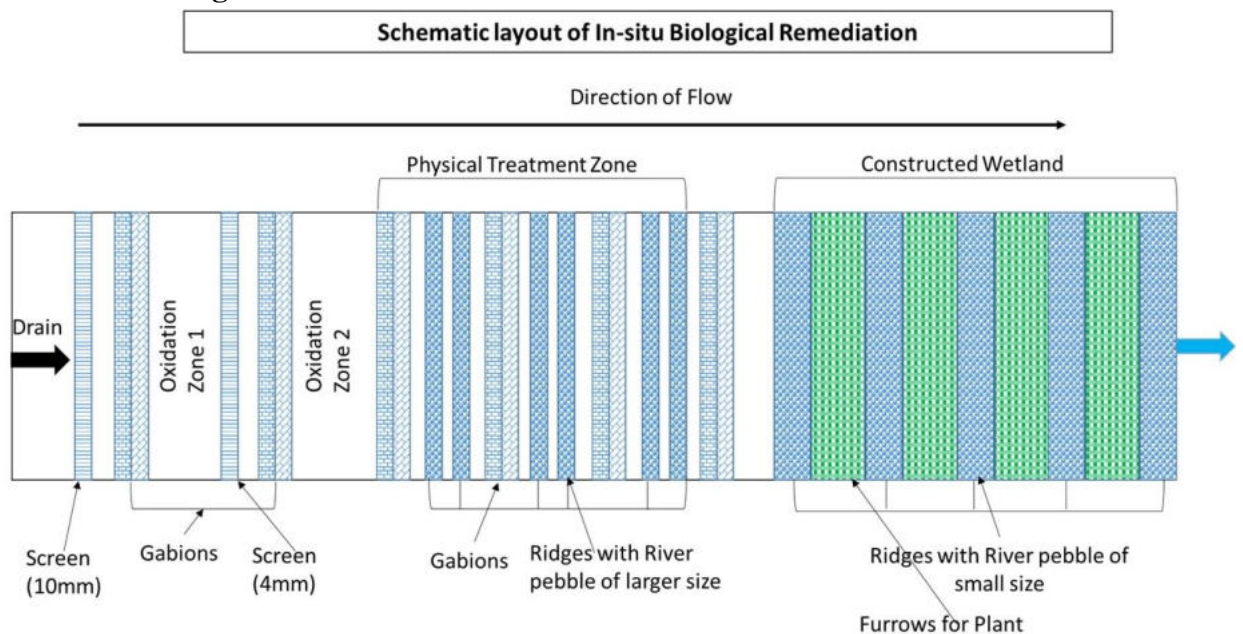

Figure 18: Schematic layout of *in-situ* Biological Remediation.

6.14 Model 14: Major sewage drain with moderate pollution load & broader channel

a) Drain hydrological characteristics:

➤ Physical Characteristics of Drainage System

Width of Drain : > 15 Meter

Depth of Flowing Water : 1 - 3 Meter

➤ Organic Loading

BOD : < 100 mg/l

➤ Hydraulic Loading

Flow : 50 -100 MLD

b) **Treatment scheme:** Facultative ponds (2 no.) + Lagoon + oxidation pond + Lagoon+ wetland or Oxidation pond (2 no.) + Physical Treatment unit (2 no.) + Constructed wetland

c) **Applicability:** This type of treatment scheme is suitable for drains carrying low pollution load (untreated sewage only) with wide channel suitable for in-situ construction. This type of model is suitable for 1st and 2nd order drains.

d) **Design aspect:** Depending on the space availability and the flow rates of the 1st and 2nd order drain, oxidation pond, and a wetland with furrows and ridges should be developed. The ridges are made of stones/ pebbles specified in the typical model. Area and depth requirement for such system shall be worked out as per design criteria (Figure 19). In in-situ treatment techniques, length of the drain is only variable parameter for area calculation whereas available width of drain will remain fixed. Therefore, any design for *in-situ* is dependent on length of the drain.

e) Schematic diagram:

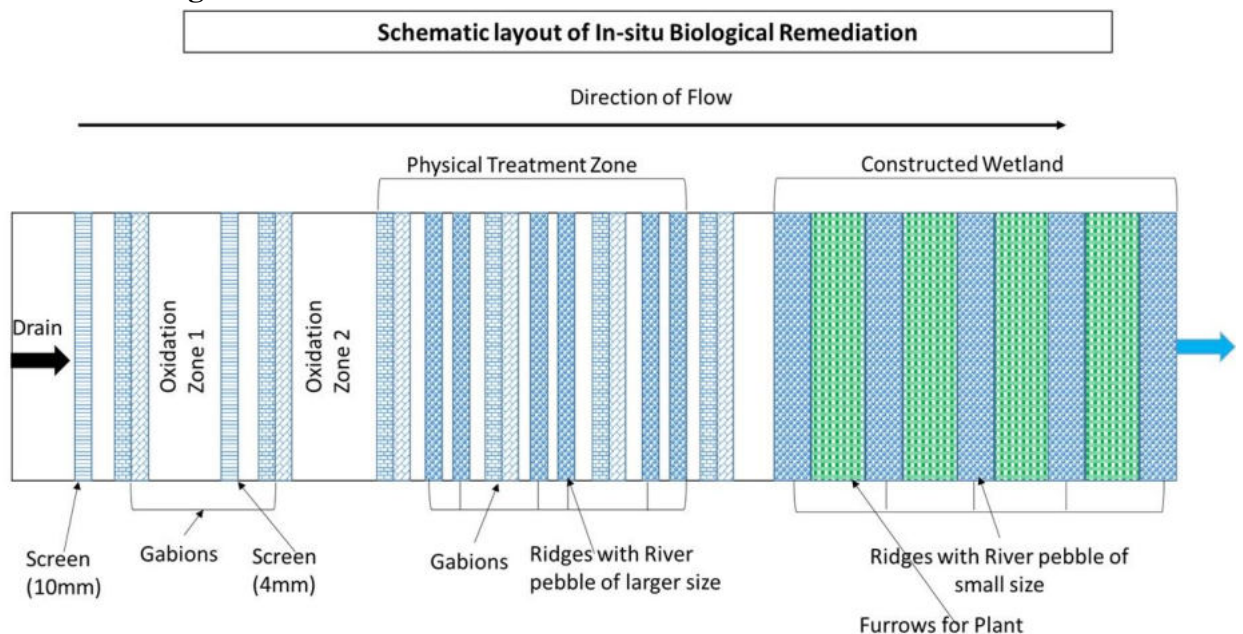

Figure 19: Schematic layout of *in-situ* Biological Remediation.

6.15 Model 15: Major sewage drain with low pollution load & broader channel

a) Drain hydrological characteristics:

➤ Physical Characteristics of Drainage System

Width of Drain : > 15 Meter

Depth of Flowing Water : 1 - 3 Meter

➤ Organic Loading

BOD : < 50 mg/l

➤ Hydraulic Loading

Flow : >100 MLD

b) **Treatment scheme:** Facultative ponds (2 no.) + Lagoon + oxidation pond (2 no.) + Lagoon+ wetland or Oxidation pond (2 no.) + Physical Treatment unit (2 no.) + Constructed wetland

c) **Applicability:** This type of treatment scheme can be used for biological remediation of polluted rivulets /rivers/major storm drains of cities by channelizing the drain bed up to 15 channels (distribution channels) and the CW stretch may extend up to 1000 m (1 km) and there may be more than 15 such stretches across a distance of 500 km (linear). The width of gabions should be at least more than 4m, as the river carry storm water.

d) **Design aspect:** Depending on the space availability and the flow rates of the 1st and 2nd order drain, oxidation pond, and a wetland with furrows and ridges should be developed. The ridges are made of stones/ pebbles specified in the typical model. Area and depth requirement for such system shall be worked out as per design criteria (Figure – 20). In in-situ treatment techniques, length of the drain is only variable parameter for area calculation whereas available width of drain will remain fixed. Therefore, any design for *in-situ* is dependent on length of the drain.

e) Schematic diagram:

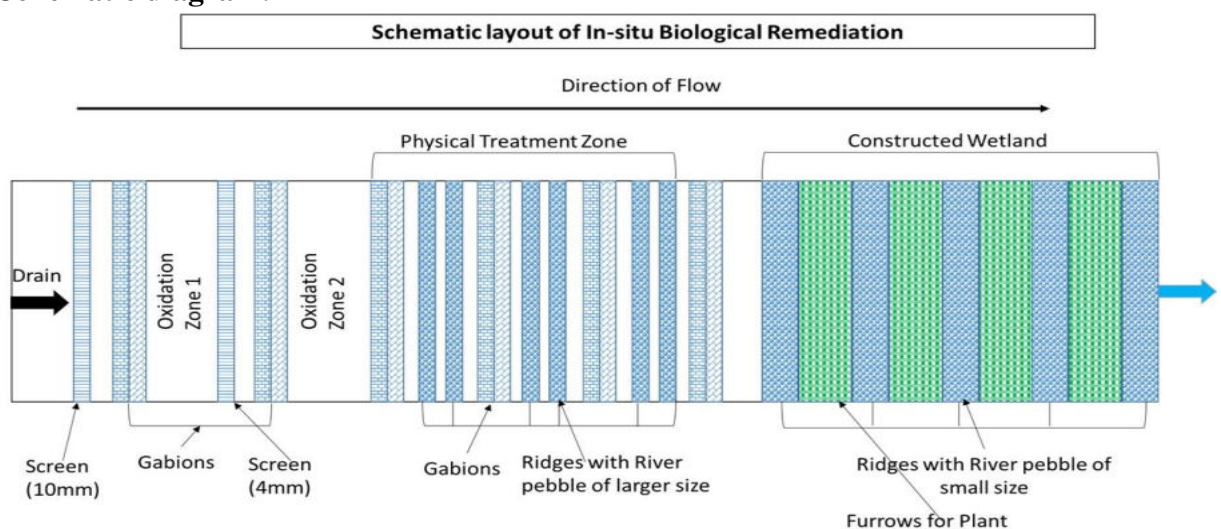

Figure 20: Schematic layout of *in-situ* Biological Remediation.

Table 1: Decision matrix for design of In-Situ / Ex-situ remediation techniques

Model no.	Description	Flow (MLD)	BOD Conc. (mg/l)	Drain Width (m)	Treatment Technology	Technology Type	Remarks
1.	Minor sewage drain with moderate pollution load & broader channel	< 20	< 100	> 15	Oxidation pond/ Facultative pond+ Lagoon+ Wetland or Waste Stabilization Pond or In-situ Activated Sludge Method	In situ	Lagoon sludge removal frequency – every 3 month, ponds HRT 20 hr min.
2.	Minor sewage drain with moderate pollution load & wide channel	< 20	< 100	3-15	Oxidation pond/ Facultative pond + Lagoon Wetland/phytoremediation or Constructed Wet Land (CWS)	In situ/ Ex situ	Treatment unit may be in situ/ex situ as per available space
3.	Minor sewage drain with moderate pollution load & narrow channel	< 20	< 100	< 3	Oxidation pond/ Facultative pond + Lagoon Wetland/phytoremediation or Constructed Wet Land (CWS)	In situ/ Ex situ	Oxidation pond will be ex situ & wet land may be in situ/ ex situ
4.	Minor sewage drain with high pollution load & broader channel	< 20	> 100	> 15	Facultative pond/Trickling filter + Lagoon Wetland/phytoremediation or Constructed Wet Land (CWS)	In situ	Sludge may be recycled partly in Facultative Trickling filler. Toxic sludge need to be disposed as per guideline

Model no.	Description	Flow (MLD)	BOD Conc. (mg/l)	Drain Width (m)	Treatment Technology	Technology Type	Remarks
5.	Minor sewage drain with high pollution load & wide channel	< 20	> 100	3-15	Facultative pond/Trickling filter + Lagoon Wetland/phytoremediation or Constructed Wet Land (CWS)	In situ/ Ex situ	All Treatment units may be in situ/ex situ as per available space
6.	Minor sewage drain with high pollution load & narrow channel	< 20	> 100	< 3	Facultative pond/Trickling filter + Lagoon Wetland/phytoremediation or Constructed Wet Land (CWS)	In situ/ Ex situ	Pond/filter/Lagoon will be ex situ & wet land may be in situ/ ex situ
7.	Medium sewage drain with low pollution load & broader channel	< 50	< 50	> 15	Facultative pond + Lagoon + Oxidation pond +Wetland or Constructed Wet Land (CWS)	In situ	Lagoon removal efficiency – 1-3 months
8.	Medium sewage drain with low pollution load & wide channel	< 50	< 50	3-15	Facultative pond + Lagoon + Oxidation pond +Wetland or Constructed Wet Land (CWS)	In situ/ Ex situ	All Treatment unit may be in situ/ex situ as per available space
9.	Medium sewage drain with moderate pollution load & broader channel	< 50	< 100	> 15	Facultative pond + Lagoon + Oxidation pond (1-2 no.) + Lagoon+ Wetland or Constructed Wet Land (CWS)	In situ	Lagoon removal efficiency – 1-3 months, pond HRT 20 Hr minimum

Model no.	Description	Flow (MLD)	BOD Conc. (mg/l)	Drain Width (m)	Treatment Technology	Technology Type	Remarks
10.	Medium sewage drain with moderate pollution load & wide channel	< 50	< 100	3-15	Facultative pond + Lagoon + Oxidation pond (1-2 no.) + Lagoon+ Wetland or Constructed Wet Land (CWS)	In situ/ Ex situ	All Treatment units may be in situ/ex situ as per available space
11.	Medium sewage drain with high pollution load & broader channel	< 50	> 100	> 15	Facultative pond (2 no.) + Lagoon + Oxidation pond (1-2 no.) + Lagoon+ Wetland or Constructed Wet Land (CWS)	In situ	Lagoon removal efficiency – 1-3 months, pond HRT 20 Hr minimum
12.	Medium sewage drain with very high pollution load & broader channel	< 50	> 200	> 15	Pond with mud ball technology Facultative pond (2 no.) + Lagoon + Oxidation pond (1-2 no.) + Lagoon+ Wetland or Constructed Wet Land (CWS)	In situ	Lagoon removal efficiency – 1-3 months, pond HRT 20 Hr minimum
13.	Major sewage drain with low high pollution load & broader channel	50-100	< 50	> 15	Facultative pond + Oxidation pond (1-2 no.)+ Lagoon + +Wetland or Constructed Wet Land (CWS)	In situ	Lagoon removal efficiency – 1-3 months
14.	Major sewage drain with moderate pollution load & broader channel	50-100	< 100	> 15	Facultative pond + Oxidation pond (1-2 no.)+ Lagoon + +Wetland or	In situ	Lagoon removal efficiency – 1-3 months, pond HRT 20 Hr minimum

Model no.	Description	Flow (MLD)	BOD Conc. (mg/l)	Drain Width (m)	Treatment Technology	Technology Type	Remarks
					Constructed Wet Land (CWS)		
15.	Major sewage drain with low pollution load & broader channel	> 100	< 50	> 15	Facultative pond (2 no.) + Lagoon + Oxidation pond (1-2 no.) + Lagoon+ Wetland or Constructed Wet Land (CWS)	In situ	Lagoon removal efficiency – 1-3 months, pond HRT 20 Hr minimum
Note: All above models are generic in nature and actual design may vary as per actual site specific requirement							

7. CHALLENGES WITH APPLICATION OF ALTERNATIVE BIOLOGICAL TREATMENT TECHNOLOGY

- Application of any *in-situ* bioremediation of wastewater requires obstruction wall (check dam / weir) to slow down the velocity of flowing water. Any flowing wastewater in storm water drains carry huge volume of floating material (solid waste, plastic waste etc.) and silt. Such obstruction to slow down of the velocity of wastewater results in trapping of floating material and deposition of silt.
- Siltation of drains will result in ponding of wastewater in upstream of such structures that may also result in flooding of upstream areas. Therefore, provisions must be made for regular removal and proper disposal of deposited silt. Floating matter collected also need to be disposed off in scientific manner.
- Spacing between the gabions need to be cleaned on regular basis as it may get choked with silt and floating materials.
- Efficiency decrease in monsoon due to high flow.
- It needs regular harvest of biomass and cleaning of physical filters.
- Difficult to operate when depth of water in drain is more than three feet.
- Slow process as compared to conventional treatment.
- Not effective in backwater, flood water from river on high tides.

8. CASE STUDIES ON DIFFERENT ALTERNATIVE TREATMENT TECHNOLOGIES

Case studies of some of the wastewater interception, diversion and treatment facilities based on alternative treatment technologies namely constructed wetland, soil biotechnology, oxidation pond, trickling filter and aerated lagoon are as under:

8.1 Constructed Wetland

- a) Constructed wetland has been established at Neela Hauz lake near Sanjay Van by Centre for Environmental Management of Degraded Ecosystems (CEMDE), Delhi University in collaboration with DDA. The lake is fed by discharge from drain having 01 MLD flow. The constructed wetland effectively results in 90% reduction in BOD and has resulted in restoration of the Neela Hauz lake which was practically dead due to high pollution load. The project was started in November, 2016 and is currently in operation; it was constructed at a cost of Rs. 10 lakhs and requires annual harvest of dead biomass and annual cleaning of physical filters and removal of sludge from oxidation ponds.
- b) In-situ constructed wetland system at Rajokari water body was installed by Irrigation and Flood Control Department, Delhi with a project cost of Rs. 77.19 lakhs. The water body is fed by a drain having flow of 600 KLD. There is 84% reduction in BOD in the water body post construction of the wetland. The wetland is currently in operation.
- c) Ex-situ remediation for water body rejuvenation through Phytoid technology developed by CSIR-NEERI. This project has been implemented Pan India in 300 sites and is currently in operation in all the sites. The cost of the project was Rs 2.2 crore per

MLD for civil construction and O&M of Rs 20 Lakhs per MLD (including manpower, consumables, electricity, testing, contingency and miscellaneous items). The land requirement for the project is 1500 m² per MLD. The technology is highly efficient with BOD and TSS of treated water reduced to ≤ 10 mg/l and ≤ 30 mg/l respectively.

- d) In-situ restoration of drains viable for flow between 1-10 MLD through RENEU Technology developed by CSIR-NEERI. The restoration of six drains in Jhusi, Prayagraj was undertaken through this technology while work order has been received to implement RENEU in 10 drains at Gorakhpur. For implementation of this technology, drains having 1-10 MLD require a stretch of 180-200m while for drains having flow greater than 10 MLD, the stretch required will be 200-600m. The cost of the project was Rs Rs835 Lakhs per MLD for civil construction and O&M of Rs Rs255 Lakhs per MLD (including manpower, consumables, electricity, testing, contingency and miscellaneous items). The technology demonstrates 40% reduction in pollution with BOD and TSS of treated water reduced to ≤ 30 mg/l and ≤ 30 mg/l respectively.
- e) Constructed wetlands are under commissioning at Bithoor to treat 2.4 MLD sewage generated from seven drains directly discharging in River Ganga from Bithoor town. The constructed wetlands are designed for in-situ treatment of sewage. During the last visit by CPCB officials, the wetlands were found to be under construction.

8.2 Soil Biotechnology

- a) In Bah Bazar STP at Devprayag, soil biotechnology is adopted for treatment of 1.4 MLD sewage. An inspection of the STP by CPCB officials revealed that through soil biotechnology, a BOD and COD reduction of 80% and 76.39% respectively was achieved while TSS levels reduced by 78.53% and ammonical nitrogen showed a reduction of 66.66%. Thus, soil biotechnology is an effective treatment technology with only one drawback being that TDS reduced by only 6.48%.

8.3 Waste Stabilization Pond

- a) In Anupshahar, an STP of 1.75 MLD at STP Zone B has adopted waste stabilization pond technology with five ponds in series for sewage treatment. The analysis report of treated samples from the STP indicated 96.77% reduction in BOD, 92.27% reduction in COD and 100% reduction in TSS. Phosphate and sulphate content also reduced by 52.67% and 35.71% respectively. However, it was observed that nitrate content reduced only by 3.84% and there was no reduction in TDS, faecal coliform. Thus, treated samples were found to comply with general discharge standards.
- b) At STP of 0.85 MLD situated in Zone A of Anupshahar, U.P., the treatment technology is waste stabilization through five ponds in series for sewage treatment. The analysis report of treated samples from the STP indicated 74.48% reduction in BOD, 59% in COD and 81.39% in TSS. Also, there was marginal reduction in TDS (3.08%), sulphate (20.51%), chloride (10.2%) and phosphate (5.91%). However, there was increase in ammonical nitrogen by 22.72% and faecal coliform levels remained unchanged. The treated effluent complied with general discharge standards thus indicating that the in-situ treatment technology is effective despite increase in ammonical nitrogen.

- c) At the Vindhyachal STP of 4 MLD capacity located in Mirzapur, U.P., waste stabilization pond technology has been adopted with a total of four ponds (with three different functions); first pond is anaerobic (28.4 m x 49.6 m x 5.5 m), second is facultative (75.4 m x 148.5 m x 2.0 m), and two are maturation ponds (Maturation-1: 55.45 m x 150.4 m x 1.45 m; Maturation – 2: 56.5 m x 150.4 m x 1.55 m). Analysis of samples from final outlet indicated a reduction of 77.5% in BOD, 75% in COD and 63.69% in TSS.

8.4 Oxidation Pond

- a) In the Fatehgarh STP of 2.7 MLD capacity, situated in FARRUKHABAD, the in-situ sewage treatment technology adopted involves primary oxidation ponds (2 in number) each of dimension 100m x 150m x 1.2 m, followed by secondary oxidation pond. The treated effluent is discharged into river Ganga. As per analysis report, the STP was found non-complying w.r.t general discharge standards for pH, BOD and TSS. However, BOD and COD showed a reduction of 53.98% and 34.95% respectively while ammonical nitrogen and phosphate levels reduced by 95.1% and 97.36% respectively.
- b) In the 6 MLD capacity STP at Baidyabati in West Bengal, there are a total of three lagoons in series for treatment of sewage before maturation pond. The analysis of treated sample indicated BOD and COD reduction of 78.57% and 27.3% respectively. However, during inspection by CPCB officials, it was observed lagoons are eutrophicated while baffle walls and embankment are partially damaged.

9.0 AN EXAMPLE OF PROPOSED TREATMENT SCHEME

A typical first order drain having flow of 500 MLD with physical characteristics like length – 20 km, width of drain varying between 30-90 meter and organic loading of 100-250 mg/l of BOD may adopt *in-situ* constructed wetland system with horizontal and free-flowing system. This system will have two oxidation ponds, two physical treatment units and a constructed wetland.

The two oxidation units of 100 m long each are separated by three gabions; the two physical treatment units of 75 m long each and have vertical channels separated by gabions. The constructed wetland is of 150 m length and has 15 furrows of 8 m width, separated by 15 ridges of 2 m width. The schematic layout of the proposed constructed wetland is given in figure-21. Depending upon the width of the drain, the number of vertical channels varies and also length and height of gabions varies from site to site. Further design details of each unit are mentioned below:

1. Oxidation Pond:

Depth: Gabions of 4m width with height of 2.5 meter;

Width: As per availability (15-90 meter)

Length: 100 meter

Number of Oxidation Pond: 02

2. Physical Filters:

Vertical channels: Width upto 8 meter, height 1-5 meter, length 75-100 meter and number of channels varies as per width of drain

Depth: Gabions of 2m width with height of 1.5 meter;

Number of Physical Filters: 02

3. Constructed Wetland Systems

Depth: Gabions of 2m width with height of 1.5 meter;

Length- 150 m long

15 furrows of 8 m wide separated by 15 ridges of 2 m wide

Actual design may vary as per available physical characteristics and organic loading of drain

➤ Expected Outcome

BOD removal: 50-70 % reduction

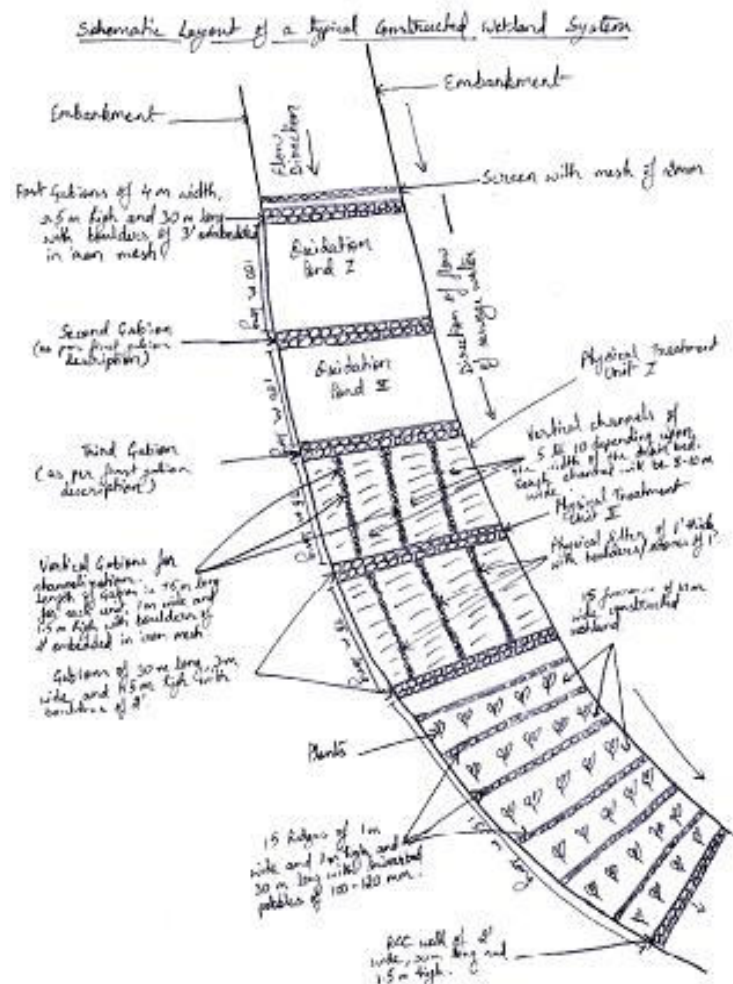

Figure 21: Schematic diagram of In-situ Remediation

9. ACKNOWLEDGEMENT

Inputs provided in the preparation of models alternate biological treatment techniques for drains by Prof.C.R. Babu, Professor Emeritus, Centre for Environmental Management of Degraded Ecosystem, University of Delhi, Prof. P. K. Mishra, Head, Department of Chemical Engineering & Technology, IIT-BHU, Varanasi; Prof. S.N. Upadhyay, Ex Director, IIT-BHU, Varanasi and Prof. C.B. Majumdar, Head, Department of Chemical Engineering, IIT Roorkee are acknowledged.

DESIGN AND PERFORMANCE DETAIL OF EX-SITU TREATMENT TECHNOLOGY

Design Criteria

▪ Requirement of Physical Characteristic of Drainage System

Length of drain : 2-20 Km

Width of drain : 2-15 m

Depth of flowing water : 0.5 2 m

▪ Organic Loading

BOD : 100-250 mg/l

COD : 150-500 mg/l

▪ Hydraulic Loading

Flow : 2-20 MLD

Volumetric loading : 100-400 BOD g/m³.day

Typical characteristics of different types of Ex-Situ treatment technologies for treating domestic sewage are mentioned in table below:

SL. No	Characteristic	Facultative type Lagoon	Aerobic flow through type Lagoon	Aerobic with solids recycling Lagoon	Oxidation Pond
1.	Suspended solids concentration , mg/l	50-150	100-350	3000-5000	-
2.	Sludge age or mean cell residence time , days	High (because of settlement)	Generally 5	Warm:10-20 Temperate:20-30 Cold: over 30	-
3.	Overall BOD removal rate K_L per day at 20 ° C	0.6-0.8	1-1.5	20-30	-
4.	Temperature coefficient,	1.035	1.035	1.01-1.05	
5.	Detention time, days	3-12	Generally 5	0.5-2	7-15 days
6.	BOD removal efficiency, %	70-90	50-60	95-98	80-90%
7.	Nitrification	None	Non favorable conditions	Likely under	-
8.	Coliform removal, %	60-99	60-90	60-90	99%
9.	Depth, m	2.5-5	2.5-5	2.5-5	1-1.5 m
10.	Land requirement, m ² /MLD	2200	2200	1111	8800
11.	Power requirement,	12-15	12-14	18-24	-

SL. No	Characteristic	Facultative type Lagoon	Aerobic flow through type Lagoon	Aerobic with solids recycling Lagoon	Oxidation Pond
	KW/Person -year				
12.	Minimum power level, KW/1000 m ³ lagoon volume	0.75-1	2.75-5	15-18	-
13.	Sludge	Accumulates in lagoon; manual removal after some years	No accumulation; solids go out with effluent	Surplus sludge withdrawn continuously (daily) and disposed off suitably	Accumulates in Oxidation Pond; manual removal after some years
14.	Outlet management	Effluent flows over a weir	Partially or fully submerged pipe outlet	Weir or pipe	Weir or pipe