

**ANALYSIS OF AIR SAMPLES
FOR
HEAVY METALS USING ICP**

BY

S. KARTHIKEYAN

CPCB, SZO

BANGALORE



SELECTION OF FILTER



Use Whatman EPM 2000 or equivalent, for Ambient Air Quality Monitoring, if heavy metals are to be analysed:

Use Glass fibre thimbles for Source Emission Monitoring, if heavy metals are to be analysed.



SAMPLE STORAGE

- After collecting the samples, transport the filters/samples to the laboratory in a shipping envelope.
- Store the samples in protective envelope up to 30°C till analysis
- The maximum holding time is usually 180 days. Analyse the samples within these prescribed time.

EXTRACTION OF SAMPLES

The sample on glass fibre filters may be extracted by one of the method

1. Ultrasonication
2. Hot plate procedure
3. Microwave extraction
(Method IO – 3.1).



WHY DIGESTION?

To reduce interference by organic matter and to convert metals associated with inorganics & particulates to a form (usually the free metals) that can be determined by AAS or ICP.

Nitric acid will digest most samples adequately.

Nitrate is an acceptable matrix for both flame and electrothermal AA and preferred matrix for ICP-MS.





Cleaning protocol

- Wash all labwares with laboratory detergent or Ultrasonication for 30 mins.
- Rinse
- Soak for minimum of 4 hours in 20% HNO₃.
- Rinse 3 times with DW
- Dry in dust free environment.





ULTRASONICATION

Power of atleast 450 W

Operating temperature of 100oC

Operating time 30 mins.



MICROWAVE EXTRACTION

Cut 1" X 8" strip or half the filter from the 8" X 10" using a template and pizza cutter by placing the edge of sample filter and roll it in such a way that it get into the centrifuge tube.

Using vinyl gloves or plastic forceps slide down the sample into the bottom of the tube.

Add 10ml of extraction solution (3% HNO₃ and 8% HCL) and ensure that it covers the entire filter sample.

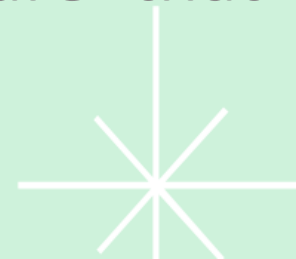

- Micro oven the sample vessels at 486 W for 23 minutes.
- Allow the pressure to dissipate, and cool in tap water for 10 minutes.
- Add 10 ml DW to sample, cap tightly and mix the contents thoroughly for 2-3 minutes to complete extraction.
- Filter the extracted fluid with Whatman no.41 and make up the final volume to 100 ml.



HOT PLATE PROCEDURE

Cut 1" X 8" strip or half the filter from the 8" X 10" using pizza cutter by placing the edge of sample filter and roll it in such a way that it get into the Beaker.

Add extraction solution (3% HNO₃ and 8% HCL) of sufficient quantity to cover the entire filter sample.

Reflux gently while covering with a watch glass for 30 minute using hot plate in a Fume Hood.



Do not allow sample to dry.

Allow to cool.

Rinse the beaker walls and wash with DW.

Add 10 ml DW to the sample and allow to stand for 30 minutes.

Filter the extracted fluid with Whatman no.41 and make up the final volume to 100 ml.

Rinse the beaker with DW and add the rinses to the flask.



ANALYTICAL TECHNIQUE



Traditional Colorimetric technique

ARC and SPARK technique

ATOMIC ABSORPTION SPECTROSCOPY

GRAPHITE FURNACE (GF AAS)

INDUCTIVELY COUPLED PLASMA —

OPTICAL EMISSION SPECTROMETRY

INDUCTIVELY COUPLED PLASMA —

MASS SPECTROMETRY



ATOMIC ABSORPTION SPECTROSCOPY



- In Atomic Absorption Spectrometry (AAS) light of a wavelength characteristic of the element of interest is allowed to pass through its atomic vapour. Some of this light is then absorbed by the atoms of that element. The amount of light that is absorbed by these atoms is then measured and used to determine the concentration of that element in the sample.



DISADVANTAGES OF AAS

- Separate Hollow Cathode Lamp is required for each element to be determined.
- Some elements give rise to oxides in the flame like Aluminium, Titanium, Tungsten, Molybdenum, Vanadium and Silica.
- In aqueous solution, the predominant anion effect the signal to a negotiable degree.
- One element at a time.
- Linear range is in the order of one to two only.

ADVANTAGES OF ICP-OES



Multielement sequential analysis capabilities

Longer linear dynamic ranges in the order of 4 to 6 times.

Only two solutions, the blank and a high standard need to be analyzed to produce a calibration curve.

Less sample dilution.

Precision of analysis is usually 1%



Free from interferences.

Chemical interferences are eliminated by the high temperature of the plasma.

Physical interferences can be compensated for easily by its multielement capability.

Spectral interferences are eliminated through use of high resolution spectrometers, advanced background correction techniques, coupled with the flexibility to choose from many possible emission lines.

INTRODUCTION



ICP-OES is a sophisticated instrument used in determination of trace concentrations of elements in sample based on atomic spectrometry, after due pre treatment.



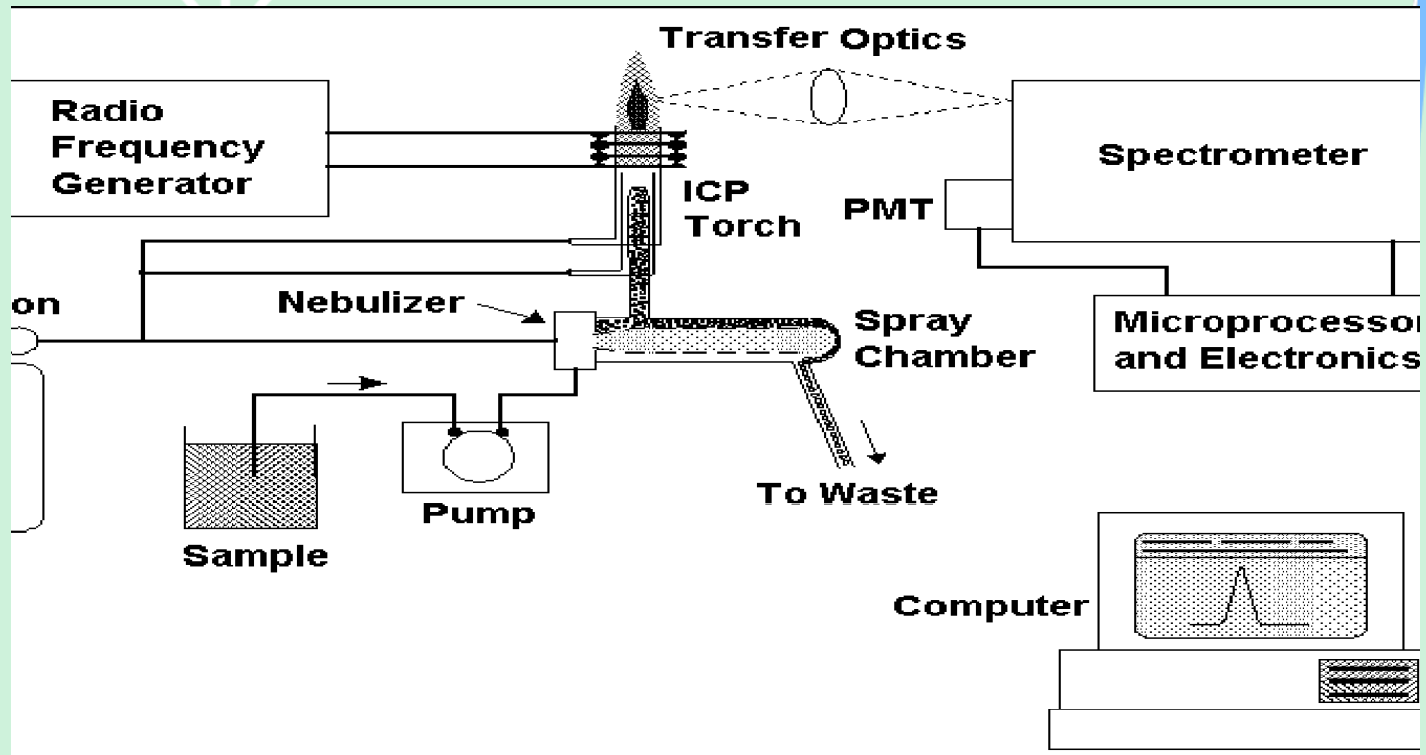

LAYOUT OF ICP-OES INSTRUMENT

INDUCTIVELY COUPLED PLASMA OPTICAL EMISSION SPECTROMETER



INDUCTIVELY COUPLING: Process of transferring energy to a system through the use of electromotive forces generated by magnetic fields.

PLASMA: A state of matter usually consisting of highly ionized gas that contains an appreciable fraction of equal numbers of ions and electrons in addition to neutral atoms and molecules.



INDUCTIVELY COUPLED PLASMA (ICP)

A high temperature discharge generated by flowing a conductive gas through a magnetic field induced by a load coil that surrounds the tubes carrying the gas.

OPTICAL EMISSION SPECTROMETRY (OES)

Elemental analysis technique that uses emission of electromagnetic radiation to detect the presence of the elements of interest.

PRINCIPLE

A SAMPLE aerosol is generated in an appropriate nebulizer and spray chamber and is carried into the plasma through an injector tube located within the torch. Due to high temperature at Plasma region, the sample undergoes desolvation, vaporization, atomization, excitation and ionization. The Normal analytical zone is the region of the Plasma from which analyte emission is measured. From the wavelength, the element is identified. From the emission count, concentration of the analyte is determined.

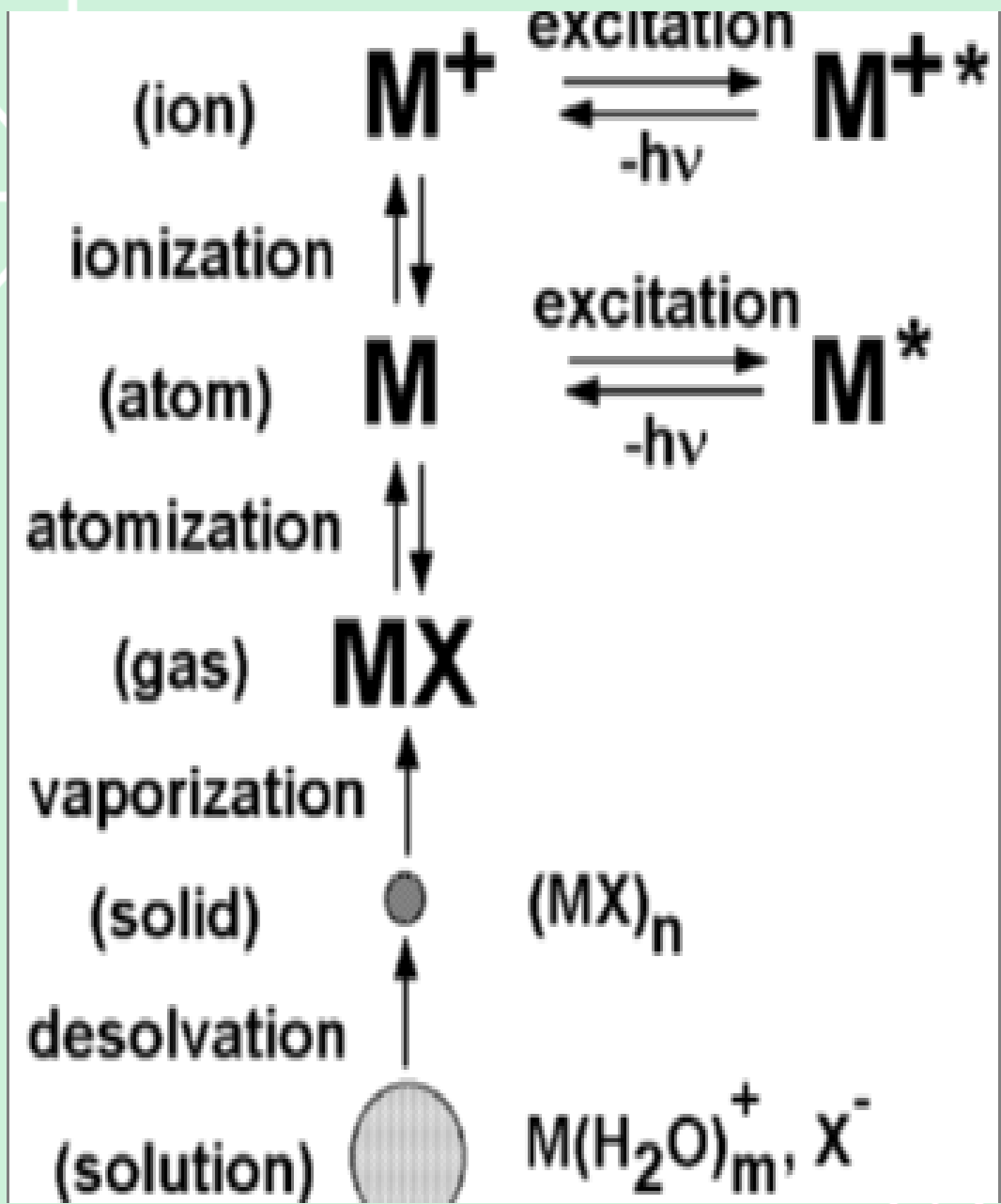

PROCESS TAKES PLACE AT ICP DISCHARGE

COMPONENTS OF ICP



1. Sample introduction system
 - A. Peristaltic pump
 - B. Nebulizer
 - C. Spray chambers
 - D. Drains

 2. Plasma -
 - A. Demountable ICP torch
 - B. RF Generators

 3. Spectrometer
 - A. Slit
 - B. Collimator
 - C. Gratings
 - D. Prism
 - E. Photo multiplier tube (PMT)
- 

PERISTALTIC PUMP

A pump in which the fluid is pushed through a length of flexible tubing by waves of mechanical contractions, usually caused by a series of rollers that travel along the length of the tubing. So, the flow is laminar without any pulse.

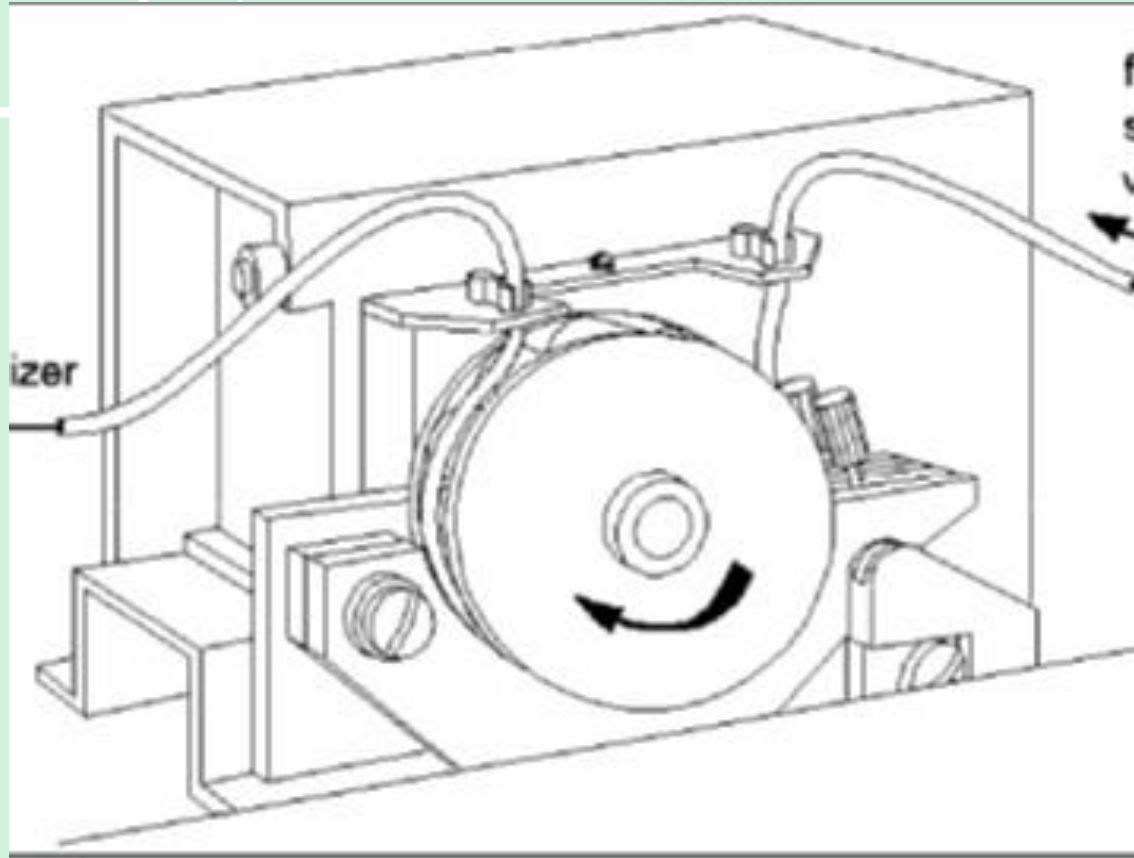

PERISTALTIC PUMP USED FOR ICP-OES



NEBULIZER



A device used to create an aerosol from a liquid.

A high speed stream of argon gas is directed perpendicular to the tip of a capillary tube. The solution is either drawn up through the capillary tube by the low pressure region created by the high speed gas or forced up the tube with a pump. In either case, contact between the high speed gas and the liquid stream causes the liquid to break up into an aerosol.



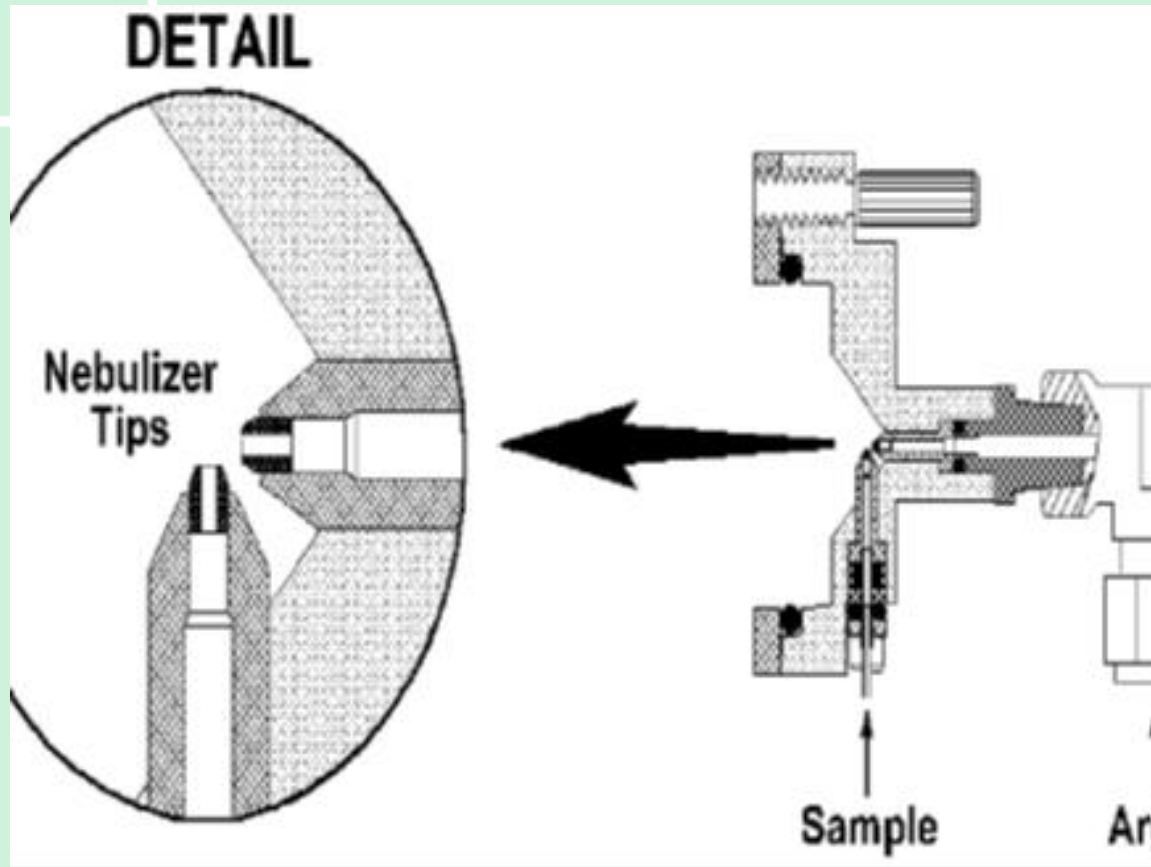

NEBULIZER



SPRAY CHAMBERS

A device placed between a nebulizer and an atomization/excitation source, whose function is to separate the aerosol droplets according to their size and to smooth out fluctuations in the sample carrying gas flow.

The primary function of spray chamber is to remove large droplets from the aerosol. A secondary purpose is to smooth out pulses that occur during nebulization, often due to pumping of the solution. For ICP operation, it is designed to allow droplets with dia of about 10 microns or smaller to pass on to the plasma.

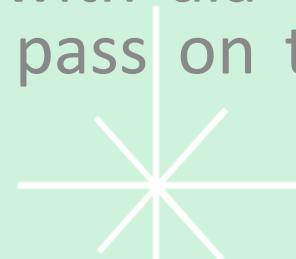

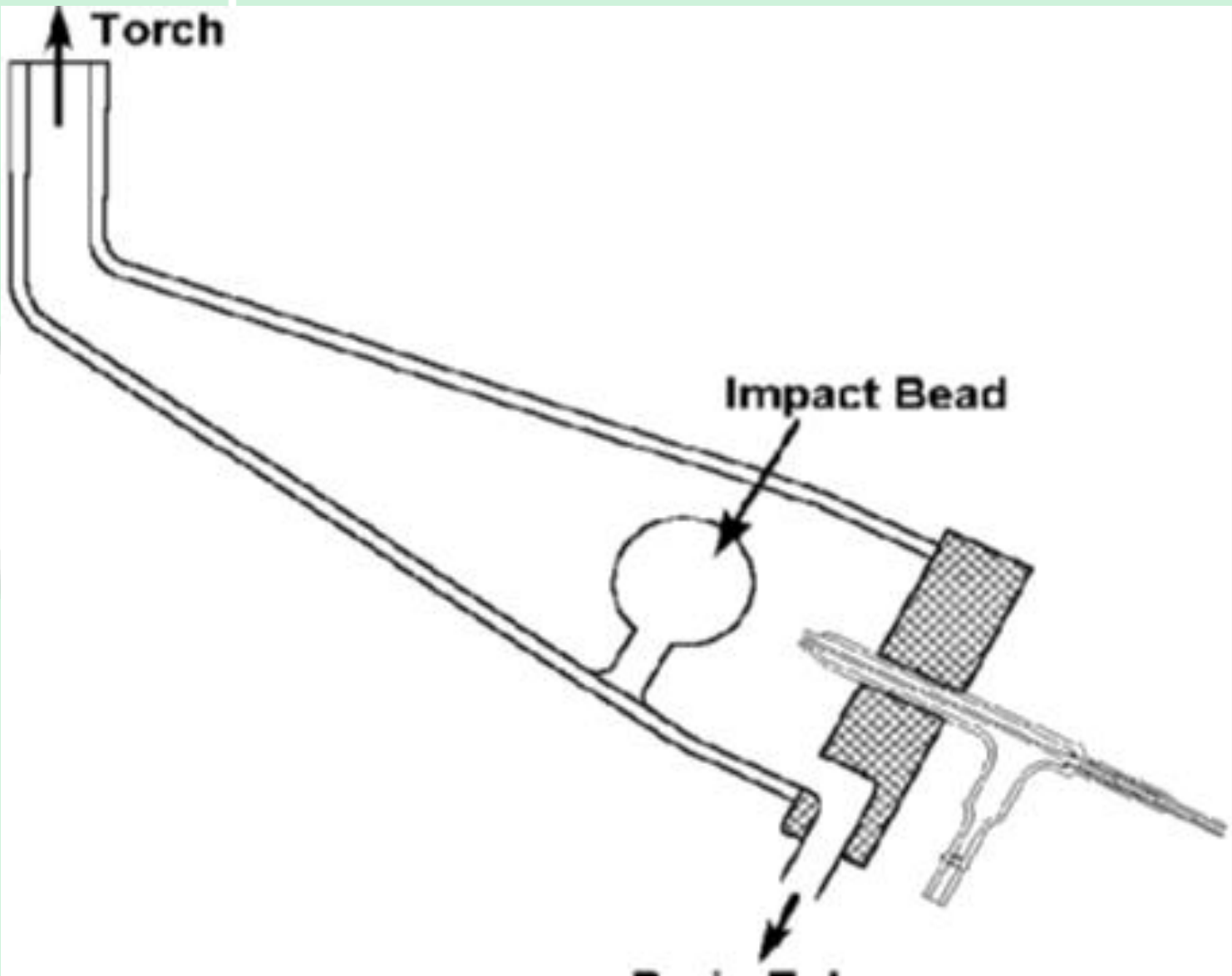

SPRAY CHAMBER

DRAINS

Drain carries excess sample from the spray chamber to a waste container can have an impact on the performance of ICP. It also provides the backpressure necessary to force the sample aerosol carrying nebulizer gas flow through the torch's injector tube and into the plasma discharge.

TORCHES

The torch contains three concentric tubes. The spacing between the two outer tubes is kept narrow so that the gas introduced between them emerges at high velocity. This outside chamber is also designed to make the gas spiral tangentially around the chamber as it proceeds upward and acts as a coolant (PLASMA FLOW). The chamber between the outer flow and the inner flow sends gas directly under the plasma toroid. This flow is called (INTERMEDIATE FLOW) and prevents carbon formation on the tip of the injector tube.

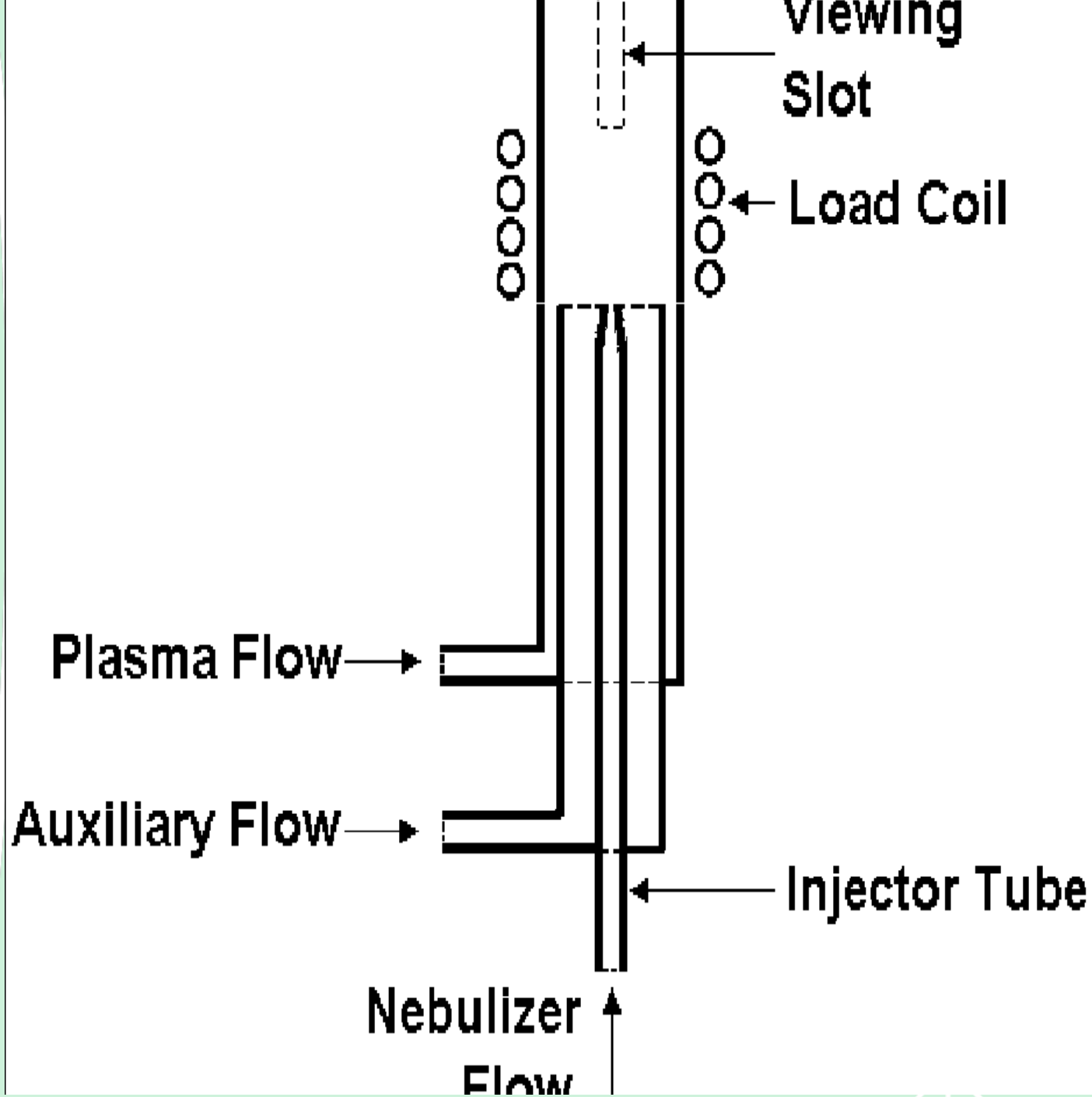

NEBULIZER FLOW



The gas flow that carries the sample aerosol is injected into the plasma through the central tube or injector. Due to small diameter at the end of the injector, the nebulizer flow can punch a hole through the plasma.



RADIO FREQUENCY GENERATORS

- The device that provides the power for the generation and sustainment of the plasma discharge. This power, typically ranging from about 700 – 1500 watts, is transferred to the plasma gas through a load coil surrounding the top of the torch.

ZONES OF ICP

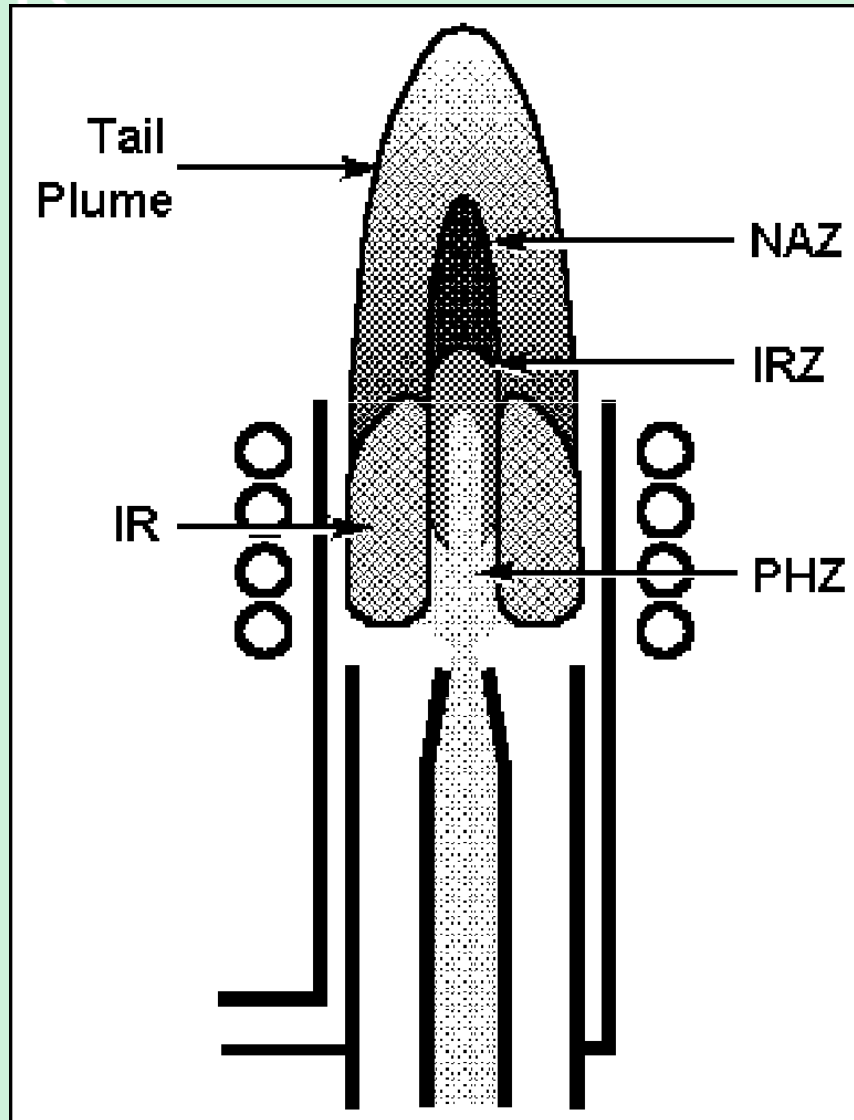

DETECTORS

Photo multiplier tube or PMT is a vacuum tube that contains a photosensitive material called the photocathode, that ejects electrons when it is struck by light. These electrons are accelerated towards a dynode which ejects two to five secondary electrons strike another dynode, ejecting more electrons which strike yet another dynode, causing a multiplicative effect along the way. Typical PMTs contain 9 to 16 stages. Collection of secondary electrons from the last dynode by the anode. The electrical current measured at the anode is then used as a relative measure of the intensity of the radiation reaching the PMT.

ICP-OES DETECTION LIMIT



- Cu, Mn, 0.4
- Cd, Ag, Zn, Co, Hg 1.0
- Cr, Fe 2.0
- Al, Na, Mo 3.0
- Ni, 5.0
- Pb, Sb 10.0
- As 20.0



SOP OF ICP



1. All operational parameters should be set up in method file
 2. All samples should be mentioned in sample file, with location number if auto sampler is used.
 3. A result file should be created in order to store the test results in that.
- 

APPLICATIONS

1. Environmentals and waters
2. Agricultural and Foods
3. Biological and clinical
4. Geological
5. Organics





Thank You

S. KARTHIKEYAN
CPCB, SZO,
BANGALORE

